

Standards-based cylinders DSBC, to ISO 15552



Standards-based cylinders DSBC, to ISO 15552

Key features

FESTO

At a glance



DIN



- Standards-based cylinders to ISO 15552 (corresponds to the withdrawn standards ISO 6431, DIN ISO 6431, VDMA 24 562, NF E 49 003.1 and UNI 10290)

- Double-acting
- For contactless position sensing
- Available with protection against rotation
- EX4: for use in potentially explosive areas
- Extensive range of accessories makes it possible to install the cylinder virtually anywhere
- Three types of cushioning available:
 - P cushioning: elastic cushioning rings/pads at both ends
 - PPS cushioning: pneumatic cushioning, self-adjusting at both ends
 - PPV cushioning: pneumatic cushioning, adjustable at both ends
- The variants can be configured according to individual needs using a modular product system
- High flexibility thanks to the wide range of variants

DSBC-...-C – With clamping unit, standard hole pattern

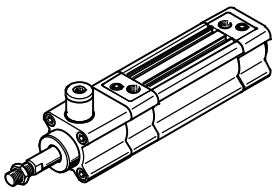

- Standard hole pattern
- Holding or clamping the piston rod in any position
- Piston rod can be held in position for long periods even with alternating loads, fluctuating operating pressure or leaks in the system

Additional measures are required for use in safety-related applications; in Europe, for example, the standards listed under the EC Machinery Directive must be observed.

Without additional measures in accordance with statutory minimum requirements, the product is not suitable for use in safety-related sections of control systems.

DSBC-...-E1/-E2/-E3 – With end-position locking, standard hole pattern

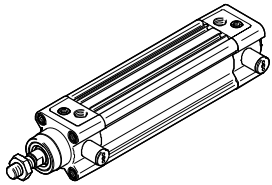

- Standard hole pattern
- Positive locking in the end position as a drop guard. In the event of a pressure drop, the piston rod is locked in its end position
- Either at one or both ends

Additional measures are required for use in safety-related applications; in Europe, for example, the standards listed under the EC Machinery Directive must be observed.

Without additional measures in accordance with statutory minimum requirements, the product is not suitable for use in safety-related sections of control systems.

DSBC-...-P2 – With bellows kit DADB, standard hole pattern

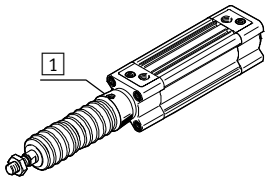

The bellows kit is a leak-free system. To prevent unwanted media from being drawn in, the supply and exhaust air must be ducted via a pressure compensation hole in the connection

part 1. The kit protects the piston rod, seal and bearings against a wide variety of media, for example:

- Dust
- Chippings
- Oil
- Grease
- Fuel

Ordering the bellows kit

An extended piston rod is absolutely essential if a bellows kit is to be used. The bellows kit can be ordered via the modular product system or as an accessory. The following must be noted in this case:

Ordering via the modular product system:

The bellows kit is supplied mounted on the bearing cap using feature P2. The required piston rod extension is automatically taken into consideration. This means that there is no need to specify a value for feature ...E.

Ordering as an accessory:

If the bellows kit is ordered as an accessory, the required value → 53 must be entered for feature ...E in the modular product system.

Standards-based cylinders DSBC, to ISO 15552

Key features

DSBC-... D3 – Sensor slots on 3 sides

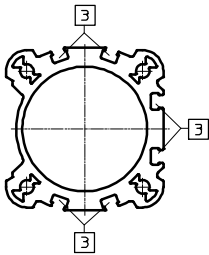

The piston position can be sensed on three sides of the drive if feature D3 is selected in the modular product system.

3 Slot for proximity sensor

Position sensing/force control

With position sensor SMAT-8M, SMAT-8E, SDAT

→ 60



Analogue position feedback possible

- Analogue output
 - 0 ... 10 V
 - 0 ... 20 mA

With proportional pressure regulator VPPM



Infinite adjustment of the gripping force possible

- Setpoint input
 - 0 ... 10 V
 - 4 ... 20 mA

Optional accessories

Mounting kit DAVM

→ 55

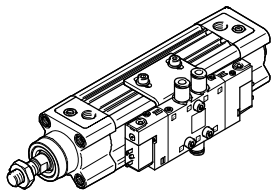

- For lateral valve assembly, directly on the drive
- Particularly suitable for decentralised use in large systems
- Mounting is only possible on the side on which the pneumatic connections are located

Application examples

Automatic screw machine

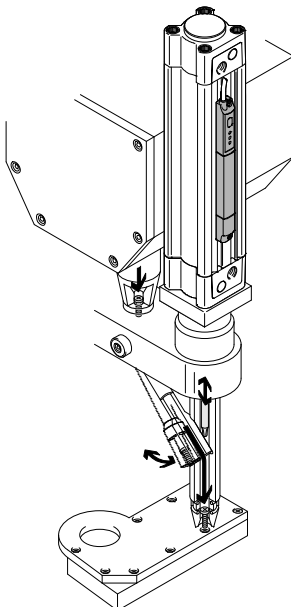

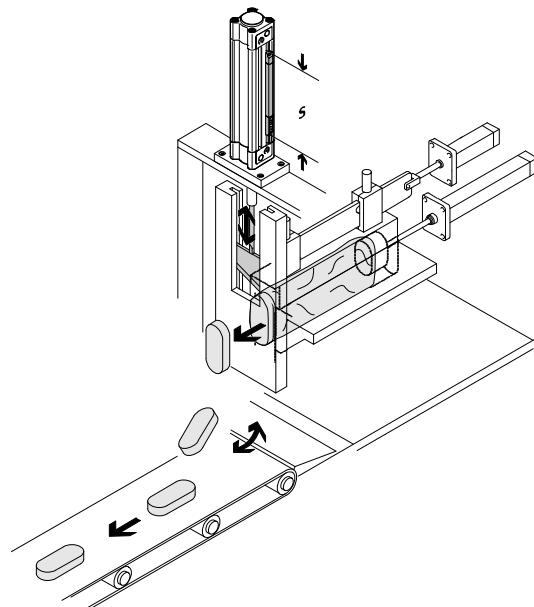

For process control





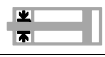
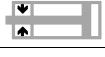
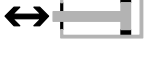
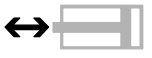
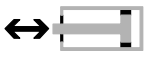
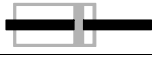







Standards-based cylinders DSBC, to ISO 15552

Key features

Variants from the modular product system		
Symbol	Key features	Description
	Q Square piston rod	Protection against rotation. For correctly oriented feeding
	C Clamping unit	Integrated clamping unit on the piston rod
	E1/E2/ E3 With end-position locking	Positive locking in the end position as a drop guard. If there is a drop in pressure, the piston rod is secured in its end position to prevent it from dropping
	L Low friction	At high piston speeds, considerably greater efficiency than other versions. The special materials considerably reduce system wear. Low-friction movements are therefore possible, especially during rapid stroke movements. Seal contains silicone grease
	U Uniform, slow movement	Low break-away pressure, suitable for slow stroke movements at a constant, judder-free speed over the full stroke range. Seal contains silicone grease
	L1 Low friction for balancer applications	At low piston speeds, low-friction operation is achieved in both directions. Special geometry of the seal enables virtually identical running characteristics regardless of the operating pressure. Additionally with low break-away pressure. Not suitable for applications with transverse loading on the piston rod.
	T Through piston rod	For working at both ends with the same force in the forward and return stroke, for attaching external stops
	F Female piston rod thread	-

Standards-based cylinders DSBC, to ISO 15552

Key features

Variants from the modular product system		
Symbol	Key features	Description
	R3 High corrosion protection	All external cylinder surfaces comply with corrosion resistance class 3 to Festo standard 940 070. The piston rod is made from corrosion and acid-resistant steel
	T1 Heat-resistant seals	Temperature range 0 ... +120 °C
	T3 Low temperature	Temperature range -40 ... +80 °C
	T4 Heat-resistant seals	Temperature range 0 ... +150 °C
	A1 Scraper variant	Increased chemical resistance: For longer service life, e.g. when using cooling lubricants.
	A2 Scraper variant	Hard scraper: The cylinder is equipped with a hard-chrome plated piston rod and a hard scraper, which protects against dry, dusty and viscous media
	A3 Scraper variant	Unlubricated operation: Cleaning processes degrease the piston rod. A special piston rod seal designed for unlubricated operation permits a longer service life compared to the standard seal
	A6 Scraper variant	Metal scraper: The cylinder is fitted with a hard-chrome plated piston rod and a metal scraper, which scrapes off hard particles (e.g. welding spatter) adhering to the piston rod. For use in welding systems, for example
	...E Piston rod extension	–
	...L Piston rod thread extension	–

Standards-based cylinders DSBC, to ISO 15552

Product range overview

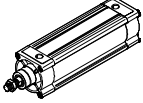
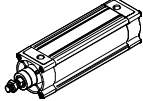
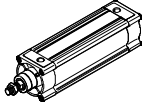
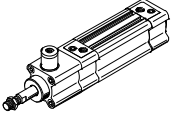
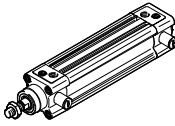
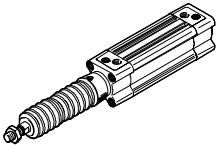
Function	Design	Type	Piston Ø	Stroke	Through piston rod	Female piston rod thread	Sensor slot on three sides	Cushioning			
			[mm]	[mm]							T
Double-acting	DSBC-...										
		DSBC-...	32, 40, 50, 63, 80, 100, 125	1 ... 2800		■	■	■	■	■	■
	DSBC-...-Q – With protection against rotation										
		DSBC-...-Q	32, 40, 50, 63, 80, 100	1 ... 1500		■	■	■	■	■	■
	DSBC-...-L/-U/-L1 – With special running characteristics										
		DSBC-...-L	32, 40, 50, 63, 80, 100	1 ... 2800		-	■	■	■	■	■
		DSBC-...-U	32, 40, 50, 63, 80, 100, 125	1 ... 2800		-	■	■	■	■	■
		DSBC-...-L1	32, 40, 50, 63, 80, 100, 125	10 ... 1000		-	■	■	■	■	-
	DSBC-...-C – With clamping unit, standard hole pattern										
		DSBC-...-C	32, 40, 50, 63, 80, 100, 125	10 ... 2000		■	■	■	■	■	■
DSBC-...-E1/-E2/-E3 – With end-position locking, standard hole pattern											
	DSBC-...-E1/-E2/-E3	32, 40, 50, 63, 80, 100	10 ... 2000		-	■	■	■	-	■	
DSBC-...-P2 – With bellows, standard hole pattern											
	DSBC-...-P2	32, 40, 50, 63, 80, 100	10 ... 500		■	■	■	■	■	■	

Standards-based cylinders DSBC, to ISO 15552

Product range overview

Type	Position sensing	High corrosion protection	Temperature range 0 ... +120 °C	Temperature range -40 ... +80 °C	Temperature range 0 ... +150 °C	Scraper variant increased chemical resistance	Scraper variant hard scraper (ring)	Scraper variant For unlubricated operation	Scraper variant Metal scraper	EU certification	Piston rod extension	Piston rod thread extension
	A	R3	T1	T3	T4	A1	A2	A3	A6	EX4	...E	...L
DSBC-...												
DSBC-...	■	■	■	■	■	■	■	■	■	■	■	■
DSBC-...-Q – With protection against rotation												
DSBC-...-Q	■	■	■	-	-	-	-	-	-	■	■	■
DSBC-...-L/-U/-L1 – With special running characteristics												
DSBC-...-L	■	-	-	-	-	-	-	-	-	-	■	■
DSBC-...-U	■	-	-	-	-	-	-	-	-	-	■	■
DSBC-...-L1	■	-	-	-	-	-	-	-	-	-	■	■
DSBC-...-C – With clamping unit, standard hole pattern												
DSBC-...-C	■	-	-	-	-	-	-	-	-	-	■	■
DSBC-...-E1/-E2/-E3 – With end-position locking, standard hole pattern												
DSBC-...-E1/ -E2/-E3	■	-	-	-	-	-	-	-	-	-	■	■
DSBC-...-P2 – With bellows, standard hole pattern												
DSBC-...-P2	■	■	-	-	-	-	-	-	-	-	■	■

Standards-based cylinders DSBC, to ISO 15552

Type codes

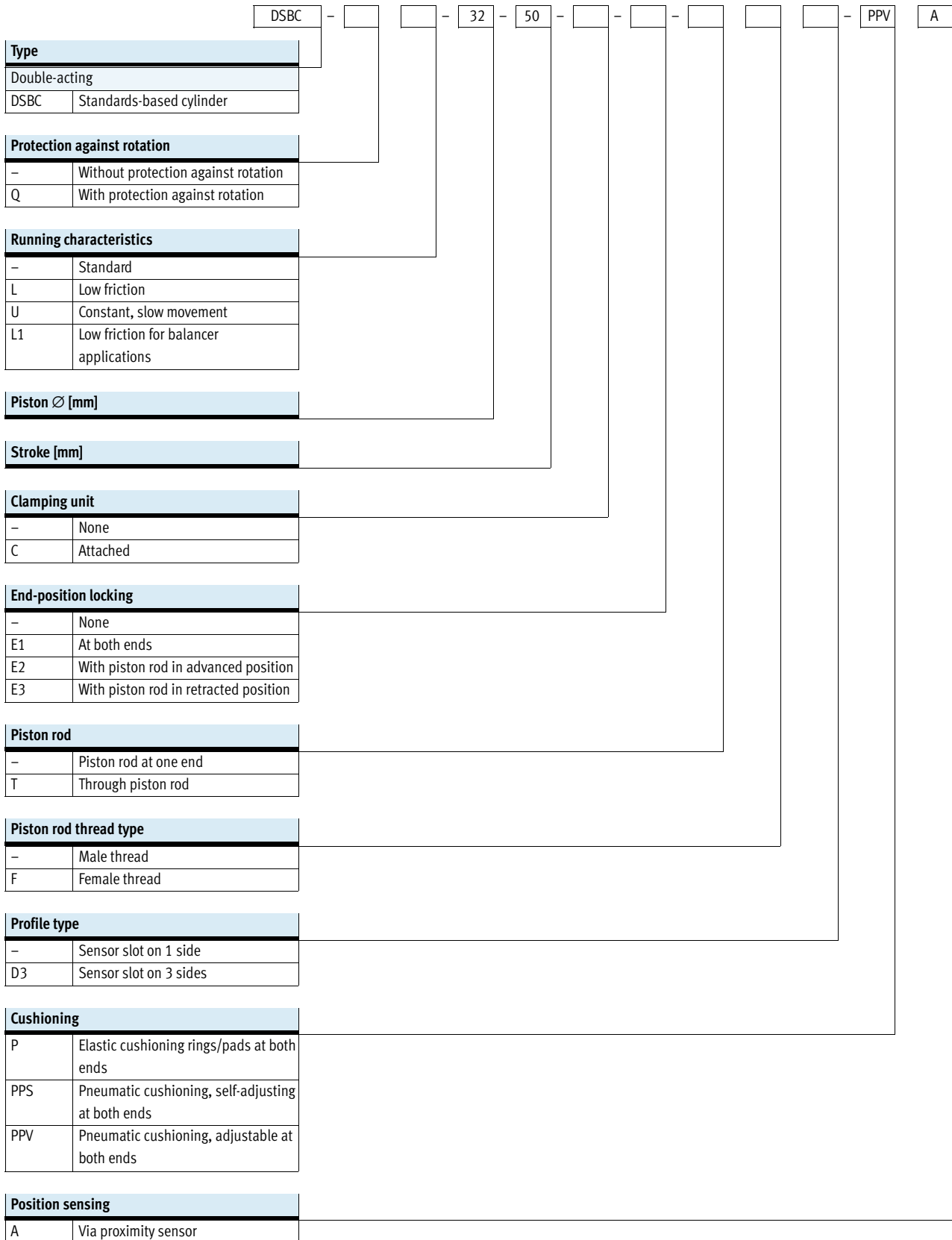

Standards-based cylinders DSBC, to ISO 15552

Type codes

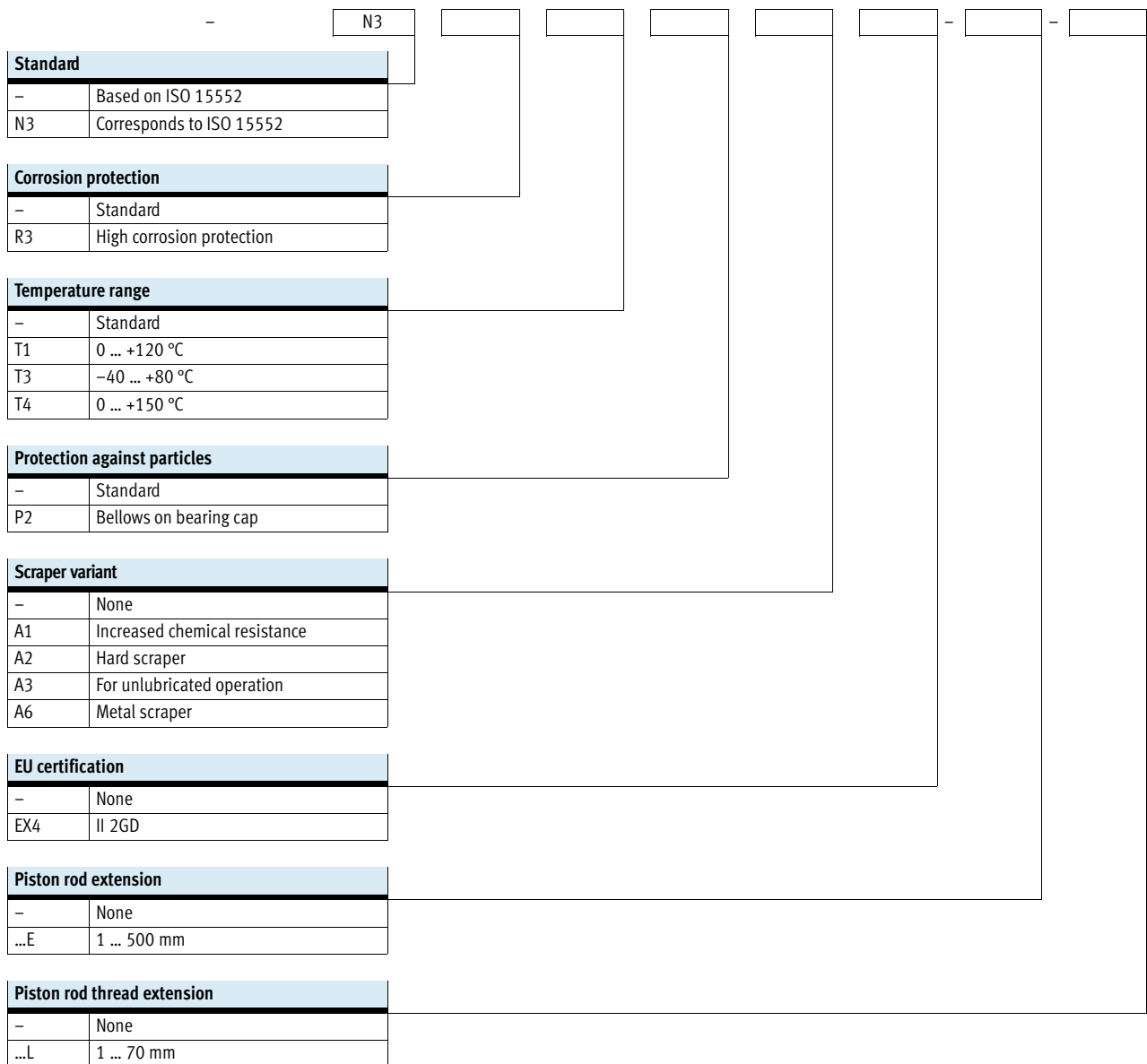

Standards-based cylinders DSBC, to ISO 15552

Peripherals overview

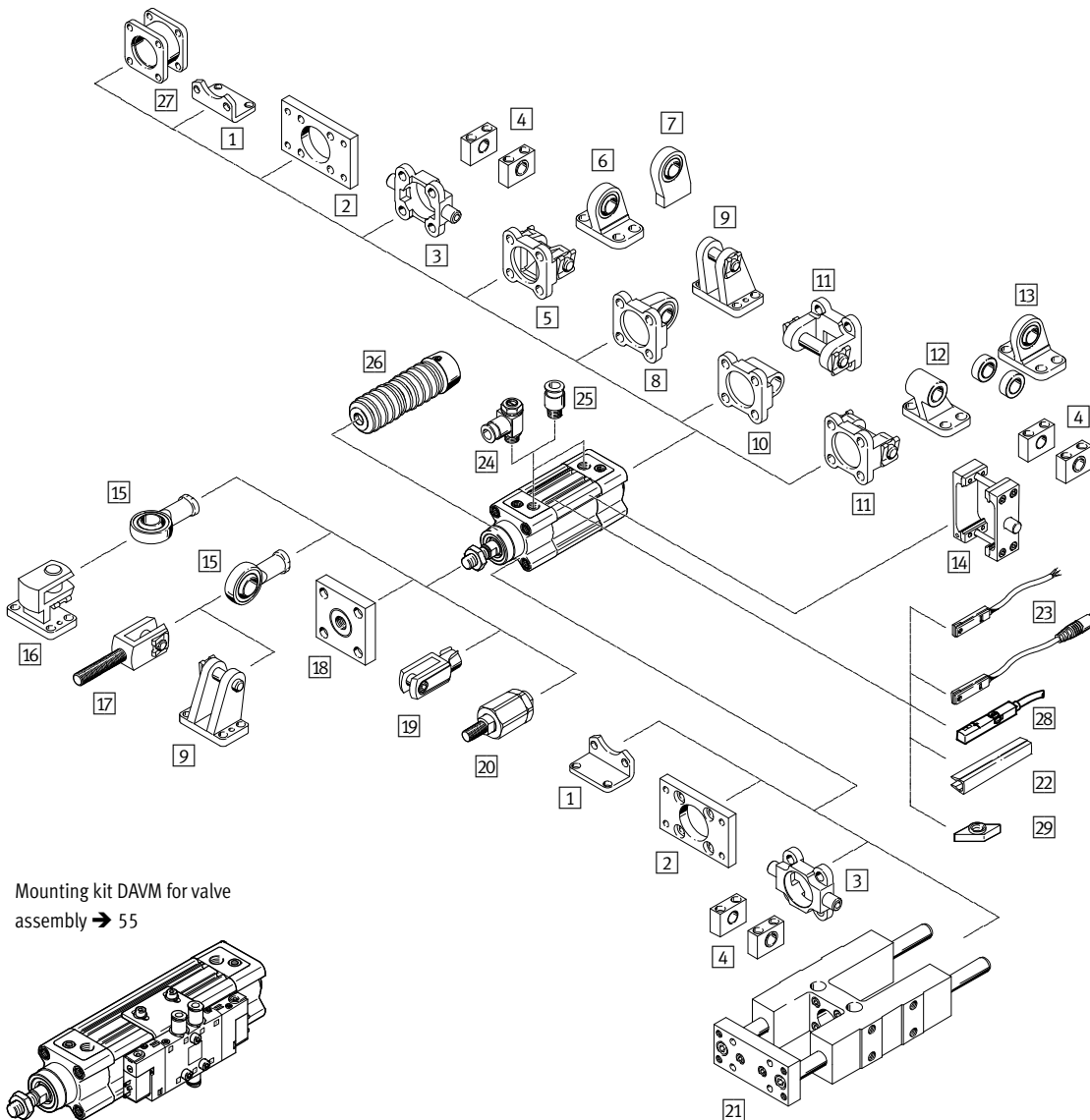

Mounting kit DAVM for valve assembly → 55

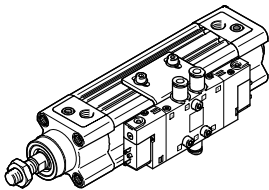

	Description	DSBC-...					→ Page/ Internet	
		-L/ -U/ -L1	-C	-E1/ -E2/ -E3	-T			
1	Foot mounting HNC/CRHNC	For bearing or end caps	■	■	■	■	■	39
2	Flange mounting FNC/CRFNG	- For bearing or end caps - Cannot be used on the bearing cap in combination with bellows kit DADB	■	■	■	■	■	40
3	Trunnion flange ZNCF/CRZNG	- For bearing or end caps - Cannot be used on the bearing cap in combination with bellows kit DADB	■	■	■	■ ¹⁾	■	41
4	Trunnion support LNZG/CRLNZG	-	■	■	■	■ ¹⁾	■	42
5	Swivel flange SNC	For end caps	■	■	■	■	-	43

1) Cannot be mounted in combination with E1.
Can only be mounted on the end cap in combination with E2.
Can only be mounted on the bearing cap in combination with E3.

Standards-based cylinders DSBC, to ISO 15552

Peripherals overview

Mounting components and accessories		DSBC-...					→ Page/ Internet	
	Description		-L/ -U/ -L1	-C	-E1/ E2/ E3	-T		
6	Clevis foot LSNG	With spherical bearing	■	■	■	■	-	48
7	Clevis foot LSNSG	Weld-on, with spherical bearing	■	■	■	■	-	48
8	Swivel flange SNCS/CRSNCS/SNCS-...-R3	With spherical bearing for end caps	■	■	■	■	-	44
9	Clevis foot LBG/LBG-...-R3	-	■	■	■	■	-	48
10	Swivel flange SNCL	For end caps	■	■	■	■	-	46
11	Swivel flange SNCB/SNCB-...-R3	For end caps	■	■	■	■	-	44
12	Clevis foot LNG/CRLNG	-	■	■	■	■	-	48
13	Clevis foot LSN	With spherical bearing	■	■	■	■	-	48
14	Trunnion mounting kit DAMT	For mounting anywhere along the cylinder profile barrel	■	■	■	■	■	47
15	Rod eye SGS/CRSGS	With spherical bearing	■	■	■	■	■	49
16	Right-angle clevis foot LQG	-	■	■	■	■	■	48
17	Rod clevis SGA	With male thread	■	■	■	■	■	49
18	Coupling piece KSG	To compensate for radial deviations	■	■	■	■	■	49
	Coupling piece KSZ	For cylinders with a non-rotating piston rod to compensate for radial deviations	■	■	■	■	■	49
19	Rod clevis SG/CRSG	Permits a swivel motion of the cylinder in one plane	■	■	■	■	■	49
20	Self-aligning rod coupler FK, CRFK	For compensating radial and angular misalignments	■	■	■	■	■	49
21	Guide unit FENG	For protecting standards-based cylinders against rotation at high torque loads	■	■	■	-	■	58
22	Slot cover ABP-5-S	For protecting the sensor cable and keeping dirt out of the sensor slots	■	■	■	■	■	60
23	Proximity sensor SME/SMT-8M	Can be integrated in the cylinder profile barrel	■	■	■	■	■	59
24	One-way flow control valve GRLA	For speed regulation	■	■	■	■	■	grla
25	Push-in fitting QS	For connecting compressed air tubing with standard O.D.	■	■	■	■	■	qs
26	Bellows kit DADB	- Protects the cylinder (piston rod, seal and bearings) against a wide range of media and thus prevents premature wear - Can only be used in combination with an extended piston rod (E)	■	-	-	-	■	50
27	Multi-position kit DPNC	For connecting two cylinders with identical piston diameters to form a multi-position cylinder	■	-	■	■	■	54
28	Position sensor SMAT, SDAT	- Continuously senses the position of the piston - Has an analogue output	■	■	■	■	■	60
29	Slot nut ABAN	Inserted in the slot from above	■	■	■	■	■	60

Standards-based cylinders DSBC, to ISO 15552

Technical data

Function
P cushioning

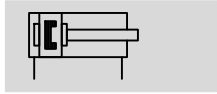

PPV cushioning

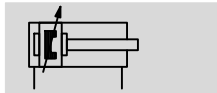

PPS cushioning

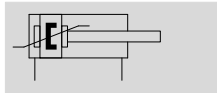

DIN



∅ - Diameter
32 ... 125 mm

— - Stroke length
1 ... 2800 mm

 - www.festo.com



General technical data								
Piston ∅		32	40	50	63	80	100	125
Design	Piston/piston rod/profile barrel							
Mode of operation	Double-acting							
Pneumatic port								
DSBC-...		G $\frac{1}{8}$	G $\frac{1}{4}$	G $\frac{1}{4}$	G $\frac{3}{8}$	G $\frac{3}{8}$	G $\frac{1}{2}$	G $\frac{1}{2}$
DSBC-...-C		M5	G $\frac{1}{8}$	G $\frac{1}{8}$	G $\frac{1}{8}$	G $\frac{1}{8}$	G $\frac{1}{8}$	G $\frac{1}{8}$
Piston rod thread		M10x1.25	M12x1.25	M16x1.5	M16x1.5	M20x1.5	M20x1.5	M27x2
Stroke								
DSBC-...	[mm]	1 ... 2800						
DSBC-...-Q	[mm]	1 ... 1500						-
DSBC-...-L1	[mm]	10 ... 1000						
DSBC-...-C	[mm]	10 ... 2000						
DSBC-...-E1/-E2/-E3	[mm]	10 ... 2000						-
DSBC-...-P2	[mm]	10 ... 500						-
DSBC-...-...E	[mm]	1 ... 2000						
DSBC-...-...L	[mm]	1 ... 2000						
Cushioning								
DSBC-...-P	Elastic cushioning rings/pads at both ends							
DSBC-...-PPV	Pneumatic cushioning, adjustable at both ends							
DSBC-...-PPS	Pneumatic cushioning, self-adjusting at both ends							
Cushioning length								
DSBC-...-PPV	[mm]	17	19	22	22	31	31	45
DSBC-...-E1/-E2/-E3	[mm]	17	19	15	15	15	15	-
Position sensing	Via proximity sensor							
Type of mounting	Via internal thread/accessories							
Mounting position	Any							

Standards-based cylinders DSBC, to ISO 15552

Technical data

Operating and environmental conditions								
Piston Ø		32	40	50	63	80	100	125
Operating medium	Compressed air to ISO 8573-1:2010 [7:4:4]							
Note on operating/pilot medium	Lubricated operation possible (in which case lubricated operation will always be required)							
Operating pressure								
DSBC-...	[bar]	0.6 ... 12		0.4 ... 12			0.2 ... 10	
DSBC-...-L ¹⁾	[bar]	0.3 ... 12	0.25 ... 12		0.2 ... 12		0.15 ... 12	-
DSBC-...-U ¹⁾	[bar]	0.1 ... 12			0.05 ... 12		0.05 ... 10	
DSBC-...-L1 ¹⁾	[bar]	0.3 ... 12	0.25 ... 12		0.2 ... 12		0.15 ... 12	0.1 ... 10
DSBC-...-C ²⁾	[bar]	1.5 ... 10						
DSBC-...-E1/-E2/-E3	[bar]	2.5 ... 12		1.5 ... 12			-	
DSBC-...-T3/-A2	[bar]	1 ... 12						1 ... 10
DSBC-...-A3	[bar]	1.5 ... 12		1 ... 12	0.6 ... 12		0.6 ... 10	
DSBC-...-A6	[bar]	1.5 ... 12						
Ambient temperature ³⁾								
DSBC-...	[°C]	-20 ... +80						
DSBC-...-L/-A1	[°C]	0 ... +80						
DSBC-...-L1	[°C]	0 ... +60						
DSBC-...-A6	[°C]	-40 ... +150						
DSBC-...-C	[°C]	-10 ... +80						
DSBC-...-T1	[°C]	0 ... +120						
DSBC-...-T3	[°C]	-40 ... +80						
DSBC-...-T4	[°C]	0 ... +150						
DSBC-...-P2	[°C]	-10 ... +80					-	
DSBC-...-EX4	[°C]	-20 ... +60						
Corrosion resistance class CRC								
DSBC-...		2 ⁴⁾						
DSBC-...-R3		3 ⁵⁾						

1) Values apply only for strokes ≤ 500 mm and after 10 double strokes.

In combination with cushioning PPV/PPS, the specifications only apply outside the cushioning range

2) Note min. release pressure → 19

3) Note operating range of proximity sensors

4) Corrosion resistance class CRC 2 to Festo standard FN 940070

Moderate corrosion stress. Indoor applications in which condensation may occur. External visible parts with primarily decorative requirements for the surface and which are in direct contact with the ambient atmosphere typical for industrial applications.

5) Corrosion resistance class CRC 3 to Festo standard FN 940070

High corrosion stress. Outdoor exposure under moderate corrosive conditions. External visible parts with primarily functional requirements for the surface and which are in direct contact with a normal industrial environment.

Standards-based cylinders DSBC, to ISO 15552

Technical data

Weight [g]							
Piston Ø	32	40	50	63	80	100	125
DSBC-...							
Product weight with 0 mm stroke	465	740	1190	1740	2660	3665	6611
Additional weight per 10 mm stroke	27	37	56	62	92	101	151
Moving mass with 0 mm stroke	110	205	365	430	810	1000	2245
Moving mass per 10 mm stroke	9	16	25	25	39	39	63
DSBC-...-Q							
Product weight with 0 mm stroke	503	755	1241	1821	2717	3827	–
Additional weight per 10 mm stroke	25	30	51	57	87	95	–
Moving mass with 0 mm stroke	115	170	332	391	757	890	–
Moving mass per 10 mm stroke	8	11	20	20	31	31	–
DSBC-...-C							
Product weight with 0 mm stroke	745	1175	1940	2920	5075	6965	12860
Additional weight per 10 mm stroke	25	35	56	62	95	103	151
Moving mass with 0 mm stroke	160	290	540	620	1200	1425	3035
Moving mass per 10 mm stroke	9	16	25	25	39	39	63
DSBC-...-E1/-E2/-E3							
Product weight with 0 mm stroke							
DSBC-...-E1	505	780	1312	1862	3018	4023	–
DSBC-...-E2	485	760	1251	1801	2839	3844	–
DSBC-...-E3	485	760	1251	1801	2839	3844	–
Additional weight per 10 mm stroke	27	37	56	62	92	101	–
Moving mass with 0 mm stroke	110	205	365	430	810	1000	–
Moving mass per 10 mm stroke	9	16	25	25	39	39	–
DSBC-...-T							
Product weight with 0 mm stroke	581	924	1523	2103	3243	4353	7450
Additional weight per 10 mm stroke	34	50	81	86	133	141	214
Moving mass with 0 mm stroke	181	339	613	684	1292	1516	3084
Moving mass per 10 mm stroke	18	32	50	50	78	78	126

Standards-based cylinders DSBC, to ISO 15552

Technical data

ATEX ¹⁾	
ATEX category for gas	II 2G
Type of (ignition) protection for gas	c T4
ATEX category for dust	II 2D
Type of (ignition) protection for dust	c T120°C
Explosion-proof ambient temperature	-20°C ≤ Ta ≤ +60°C
CE marking (see declaration of conformity)	As per EU Explosion Protection Directive (ATEX)

1) Note the ATEX certification of the accessories.

Forces [N] and impact energy [J]							
Piston Ø	32	40	50	63	80	100	125
Theoretical force at 6 bar, advancing	483	754	1178	1870	3016	4712	7363
Theoretical force at 6 bar, retracting	415	633	990	1682	2721	4418	6881
Max. impact energy in the end positions							
DSBC-...	0.4 ¹⁾	0.7	1.0	1.3	1.8	2.5	3.3
DSBC-...-L/-U/-L1/-T1/-T3/-T4	0.2 ¹⁾	0.35	0.5	0.65	0.9	1.25	1.65

1) The max. energy in combination with the trunnion mounting kit DAMT is 0.1 J.

Permissible impact velocity

$$v_{perm.} = \sqrt{\frac{2 \times E_{perm.}}{m_{intrinsic} + m_{Load}}}$$

Maximum permissible load:

$$m_{Load} = \frac{2 \times E_{perm.}}{v^2} - m_{intrinsic}$$

$v_{perm.}$ Permissible impact velocity
 $E_{perm.}$ Max. impact energy
 $m_{intrinsic}$ Moving mass (drive)
 m_{Load} Moving payload

Standards-based cylinders DSBC, to ISO 15552

Technical data

Max. transverse force F_q as a function of stroke length l

Horizontal mounting

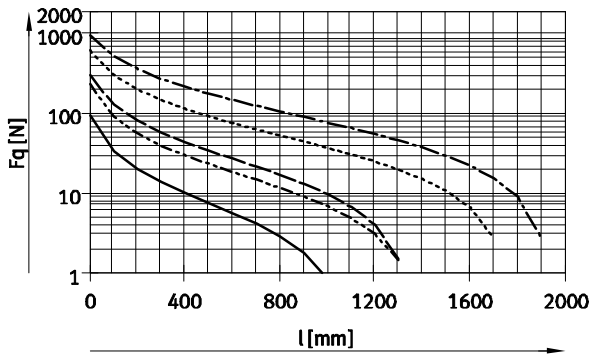

Vertical mounting

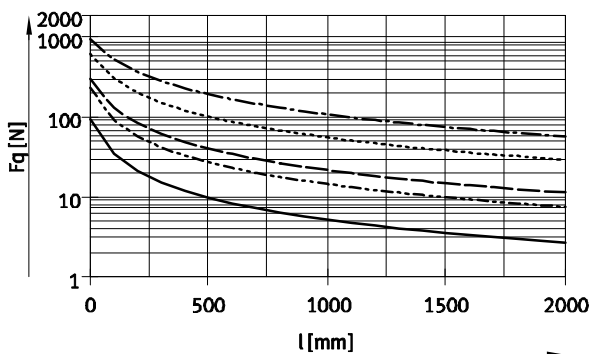

- \varnothing 32 - - - - \varnothing 80/100
- - - - \varnothing 40 - · - · \varnothing 125
- · - · \varnothing 50/63



Note
No transverse forces are permitted in combination with feature DSBC-...-L1.

Permissible torsional backlash with variant Q – With protection against rotation							
Piston \varnothing		32	40	50	63	80	100
Torsional backlash	[°]	± 0.65	± 0.6	± 0.45	± 0.45	± 0.45	± 0.45

Standards-based cylinders DSBC, to ISO 15552

Technical data

Max. transverse force F_q as a function of stroke length l and lever arm s

Q – With protection against rotation

Ø 32

Max. torque = 800 Nmm/max. stroke = 300 mm

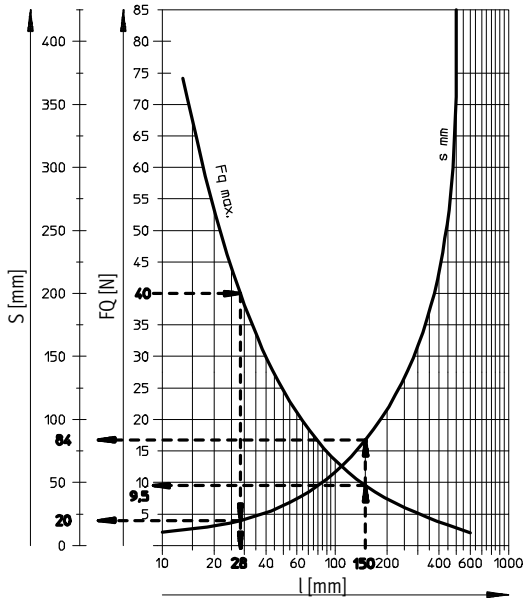

Ø 40

Max. torque = 1100 Nmm/max. stroke = 400 mm

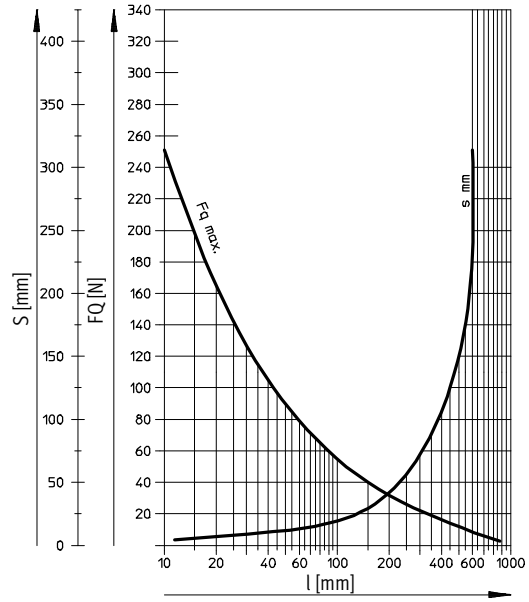

Ø 50/63

Max. torque = 1500 Nmm/max. stroke = 500 mm

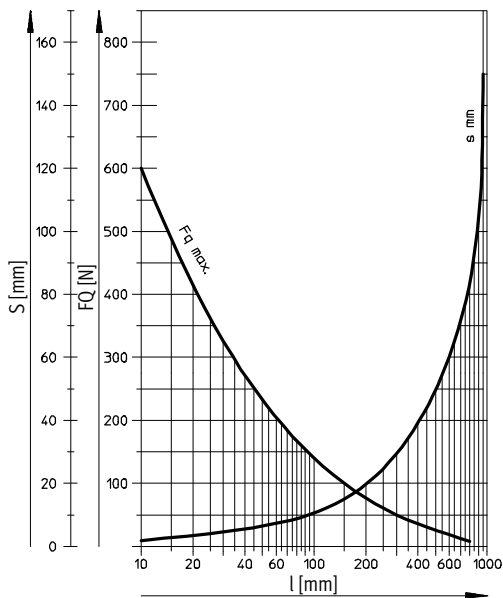

Ø 80/100

Max. torque = 3000 Nmm/max. stroke = 600 mm

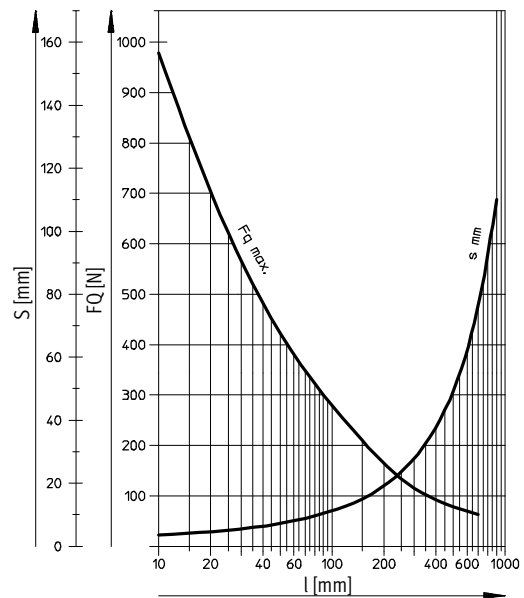

Examples for piston Ø 32 mm

Example 1:

Stroke length l = 150 mm

Result: Permissible

Transverse force F_q

= 9.5 N

Lever arm s = 84 mm

Example 2:

Transverse force F_q

= 40 N

Result: Permissible

Stroke length l = 28 mm

Lever arm s = 20 mm

Example 3:

Stroke length l = 150 mm

Lever arm s = 100 mm

$F_q = \frac{\text{Max. torque } 800 \text{ Nmm}}{\text{Lever arm } 100 \text{ mm}}$

= 8 N

Result: Permissible

$F_q = 8 \text{ N} < F_{q\text{max.}} = 9.5 \text{ N}$

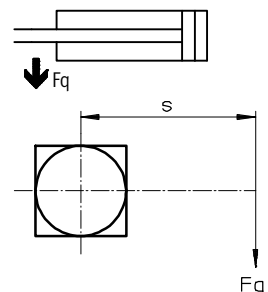

Standards-based cylinders DSBC, to ISO 15552

Technical data

Materials

Sectional view – Basic design

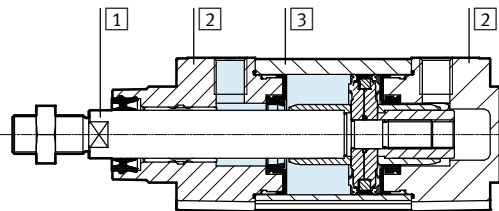

With clamping unit

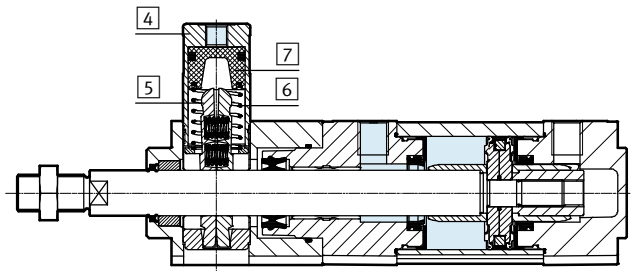

With end-position locking

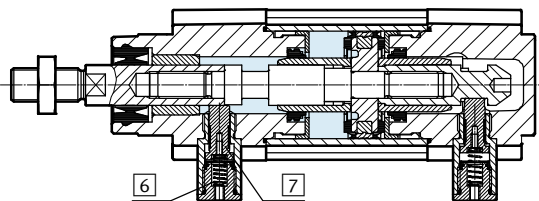

Standards-based cylinder

1	Piston rod	
	DSBC-...	High-alloy steel
	DSBC-...-R3	High-alloy stainless steel
	DSBC-...-A2/-A6	Hard-chromium plated tempered steel
2	Cover	Die-cast aluminium, coated
3	Profile barrel	Anodised wrought aluminium alloy
4	Housing, clamping unit	Anodised wrought aluminium alloy
5	Clamping jaw	Brass
6	Spring	
	DSBC-...-C	Spring steel
	DSBC-...-E1/E2/E3	High-alloy stainless steel
7	Piston	
	DSBC-...-C	POM
	DSBC-...-E1/E2/E3	Hardened steel
–	Piston rod seal	
	DSBC-...	PUR
	DSBC-...-L/-U	FPM
	DSBC-...-L1	HNBR
	DSBC-...-T1/-T4/-A1	FPM
	DSBC-...-T3	PUR (suitable for low temperatures)
DSBC-...-A3	UHMW-PE	
	Rod wiper seal	
	DSBC-...-A6	CuZn
	Buffer seal	
	DSBC-...	PUR
	DSBC-...-U	FPM
	DSBC-...-T1/-T4	FPM
	DSBC-...-T3	PUR (suitable for low temperatures)
	Cushioning boss	
	DSBC-...	POM
	DSBC-...-L/-U	Aluminium
	DSBC-...-T1/-T3/-T4	Aluminium
–	Note on materials	
	DSBC-...	RoHS compliant
	DSBC-...-L/U/-T3/-T4/-A3	Contains paint-wetting impairment substances

Standards-based cylinders DSBC, to ISO 15552

Technical data

Technical data DSBC-...-C – With clamping unit

- The specified holding force refers to a static load. If this value is exceeded, slippage may occur. Dynamic forces occurring during operation must not exceed the static holding force. The clamping unit is not backlash-free in the clamped condition if varying loads are applied to the piston rod.
- The clamping unit may only be released if the forces at the piston have reached equilibrium. Otherwise, there is a risk of accidents due to sudden movement of the piston rod. Blocking off the air supply at both ends (e.g. with a 5/3-way valve) does not provide any safety.

Piston Ø		32	40	50	63	80	100	125
Clamping type with effective direction		At both ends						
		Clamping via spring force						
		Release through compressed air						
Static holding force	[N]	600	1000	1400	2000	5000	5000	7500
Max. axial play under load	[mm]	0.5	0.5	0.8	0.8	0.8	0.8	1.8
Min. release pressure	[bar]	3						

Technical data DSBC-...-E1/-E2/-E3 – With end-position locking

- End-position locking should only be operated in conjunction with double-acting cylinders with exhaust air flow control in order to ensure that the lock is always completely released prior to starting the drive movement.
- The end-position locking may only be released if the forces at the piston have reached equilibrium. Otherwise, there is a risk of accidents due to sudden movement of the piston rod. Blocking off the air supply at both ends (e.g. with a 5/3-way valve) does not provide any safety.
- Locking can be performed from any stroke position once the drive is brought mechanically into its end position.
- A very tightly set end-position cushioning (more than 50% closed) can result in the locking bolt not engaging reliably, resulting in premature wear.
- The exhaust hole must not be closed.

Piston Ø		32	40	50	63	80	100
Clamping type		Positive locking through stop cylinder					
		Release through compressed air					
Static holding force	[N]	500	500	2000	2000	5000	5000
Max. axial backlash with end position locked	[mm]	1.3	1.3	1.3	1.5	1.5	1.5
Min. unlocking pressure	[bar]	≤ 2.5		≤ 1.5			
Max. locking pressure	[bar]	≥ 0.5					

Sizing example

When sizing pneumatic cylinders it is recommended as a basic principle that only 50% of the indicated theoretical forces (see above) be used.

Given:

Mounting position = vertical
 Workpiece load = 44 kg
 $F = m \times g = 44 \text{ kg} \times 9.81 \text{ m/s}^2 = 431.6 \text{ N}$

To be calculated:

Suitable piston Ø

Example with 32 mm piston Ø:

Theoretical force at 6 bar, advancing = 483 N

50% of the theoretical force = 241.5 N

Static holding force with 32 mm piston Ø = 500 N

The static holding force of end-position locking is within the permissible range (max. 500 N) for a workpiece load of 44 kg (431.6 N), however the cylinder would be at 89% capacity.

Result:

A cylinder with a piston Ø of 40 mm is therefore recommended for this application.

Standards-based cylinders DSBC, to ISO 15552

Technical data

FESTO

Dimensions

Download CAD data → www.festo.com

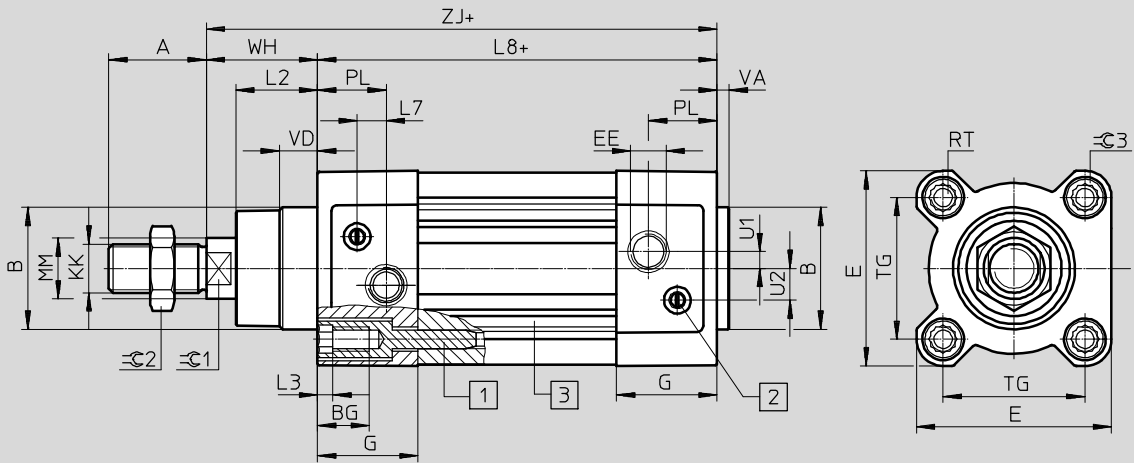

Ø 80 ... 125

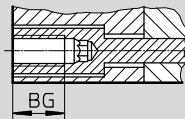

Ø 125

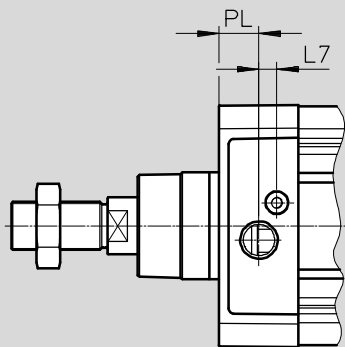

- + = plus stroke length
- 1 Socket head screw with female thread for mounting components
- 2 Regulating screw for adjustable end-position cushioning
- 3 Sensor slot for proximity sensor

Variant

T – Through piston rod

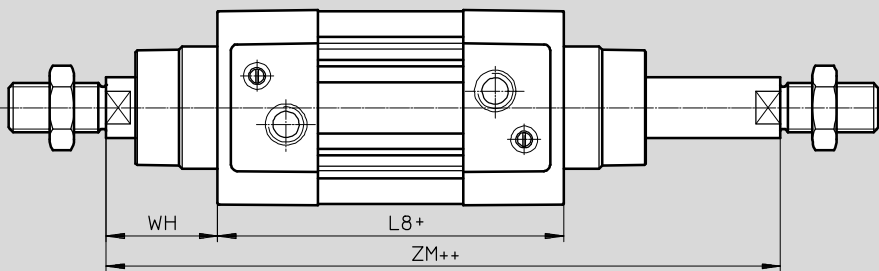

- + = plus stroke length
- ++ = plus 2x stroke length

Standards-based cylinders DSBC, to ISO 15552

Technical data

∅ [mm]	A -0.5	B ∅ d11	BG Min.	E +0.5	EE	G -0.2	U2 ±0.1	U1 ±0.1	KK
32	22	30	16	45	G1/8	28	5.7	5.25	M10x1.25
40	24	35	16	54	G1/4	33	8	4	M12x1.25
50	32	40	16	64	G1/4	33	10.4	5.5	M16x1.5
63	32	45	16	75	G3/8	40.5	12.75	6.25	M16x1.5
80	40	45	17	93	G3/8	43	12.5	8	M20x1.5
100	40	55	17	110	G1/2	48	13.5	10	M20x1.5
125	54	60	20	136	G1/2	44.7	13	8	M27x2

∅ [mm]	L2	L3 Max.	L7	L8 ±0.4	MM ∅	PM ±0.1	RT	TG ±0.3
32	18 _{-0.2}	5	6.5	94	12	19.5	M6	32.5
40	21.3 _{-0.2}	5	7.5	105	16	22.5	M6	38
50	26.8 _{-0.2}	5	9.5	106	20	22.5	M8	46.5
63	27 _{-0.2}	5	9	121	20	27.5	M8	56.5
80	34.2 _{-0.2}	-	11	128	25	30	M10	72
100	38 _{-0.2}	-	7.5	138	25	31.5	M10	89
125	45.5 _{-0.3}	-	10	160	32	22.5	M12	110

∅ [mm]	VA	VD +0.5	WH +2.2	ZJ +1.8	ZM +1	≈C1	≈C2	≈C3
32	4 _{-0.2}	10	25	119.1	146.1	10	16	6
40	4 _{-0.2}	10.5	28.7	133.9	164.8	13	18	6
50	4 _{-0.2}	11.5	35.6	141.8	179.8	17	24	8
63	4 _{-0.2}	15	35.9	157.1	195.4	17	24	8
80	4 _{-0.2}	15.7	45.4	173.6	221	22	30	6
100	4 _{-0.2}	19.2	49.3	187.5	238.8	22	30	6
125	6 _{-0.3}	20.5	64.1	225	290	27	41	8

Standards-based cylinders DSBC, to ISO 15552

Technical data

FESTO

Dimensions – Variants

Download CAD data → www.festo.com

Q – With protection against rotation

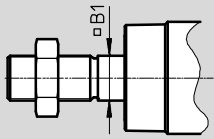

- - Note

In combination with variant T, the piston rod is protected against rotation at one end.

F – Female thread

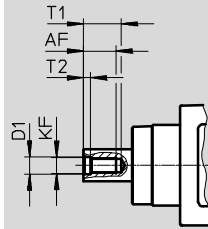

- - Note

In combination with variant T, the piston rod has female threads at both ends.

...E – Piston rod extension

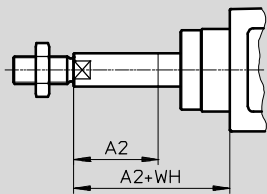

- - Note

Piston rod extension at one end in combination with the variant T. Piston rod extension only at the square piston rod in combination with the variant T and Q.

...L – Piston rod thread extension

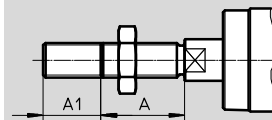

- - Note

In combination with variant T, the piston rod thread is extended at both ends.

D3 – Sensor slot on 3 sides

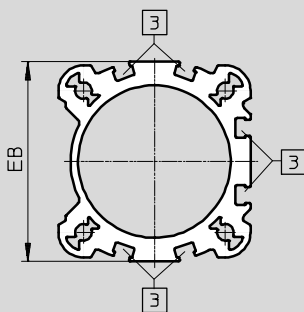

Sensor slot for proximity sensor

Standards-based cylinders DSBC, to ISO 15552

Technical data

∅ [mm]	A	A1		A2		AF Min.
		Min.	Max.	Min.	Max.	
32	22	1	35	1	500	12
40	24	1	35	1	500	12
50	32	1	70	1	500	16
63	32	1	70	1	500	16
80	40	1	70	1	500	20
100	40	1	70	1	500	20
125	54	1	70	1	500	32

∅ [mm]	B1	D1	EB	KF	T1	T2	WH +2.2
					Max.		
32	10	6.4	47 _{-0.3}	M6	16	2.6	25
40	12	8.4	54.8 ^{+0.3}	M8	16	3.3	28.7
50	16	10.5	65.5 ^{+0.3/-0.05}	M10	21	4.7	35.6
63	16	10.5	76 ₋₁	M10	21	4.7	35.9
80	20	13	92 _{-0.5}	M12	26.5	6.1	45.4
100	20	13	109 _{-0.5}	M12	26.5	6.1	49.3
125	-	17	132 ^{+0.8}	M16	40	8	64.1

Standards-based cylinders DSBC, to ISO 15552

Technical data

Dimensions – Variants

Download CAD data → www.festo.com

C – Clamping unit

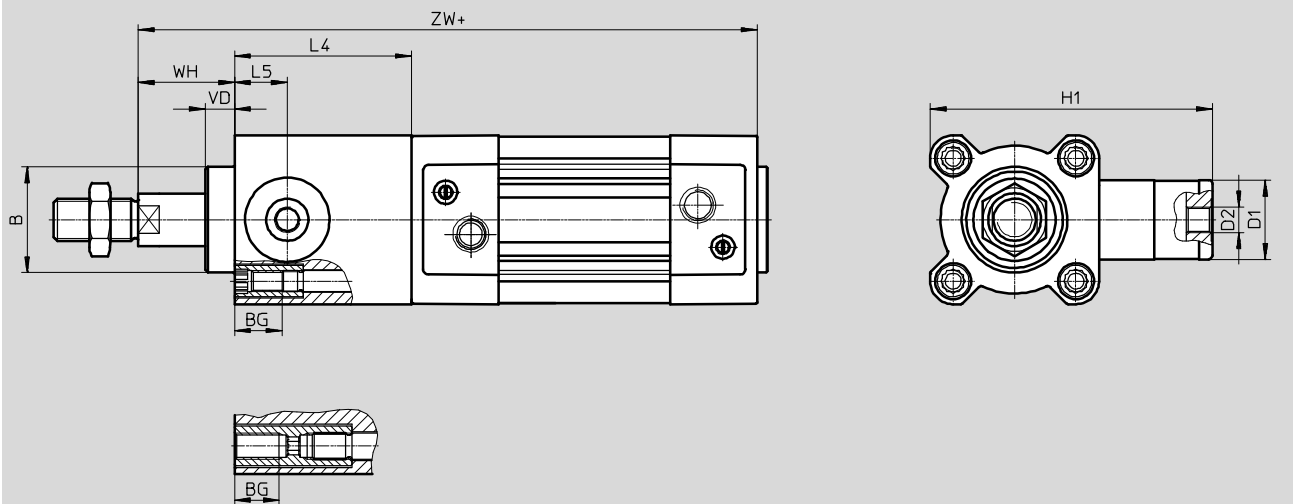

-  - Note

The clamping unit can only be selected with variant T in combination with variant Q.

The clamping unit is mounted on the round piston rod end in combination with variants T and Q.

+ = plus stroke length

∅	B	BG	D1	D2	H1	L4	L5	VD	WH	ZW
[mm]	∅ d11					±0.2				±1.8
32	30	16	20	M5	67	45	14	11.5	26	164.1
40	35	16	24	G $\frac{1}{8}$	88	53	16	11.5	30	186.9
50	40	16	30	G $\frac{1}{8}$	107	67	20	11	37	208.8
63	45	16	38	G $\frac{1}{8}$	123	76	24	11	37	233.1
80	45	17	48	G $\frac{1}{8}$	165	95	31.5	12.5	46	268.6
100	55	17	48	G $\frac{1}{8}$	174	98	31	12	51	285.7
125	60	20	65	G $\frac{1}{8}$	208	125	42	27.5	65	349.3

Standards-based cylinders DSBC, to ISO 15552

Technical data

Dimensions – Variants

Download CAD data → www.festo.com

E1/E2/E3 – End-position locking

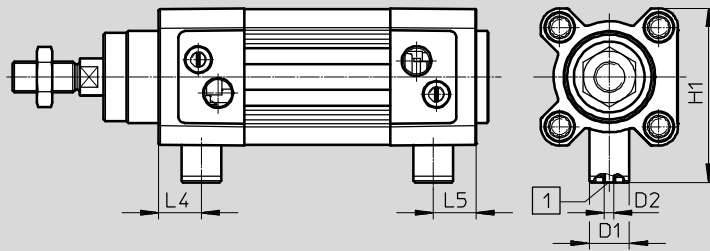

- - Note

1 The connection is used for the manual interlock and/or ducted exhaust air. It must not be sealed or pressurised.

E1 - End-position locking at both ends

∅	D1 ∅	D2	H1	L4	L5
[mm]					
32	13	M3	57.5	14	14
40	13	M3	64	17	17
50	20	M5	78.5	18	18
63	20	M5	84.5	25	25
80	30	M5	105	22	22
100	30	M5	113.5	25.5	25.5

E2 – End-position locking with advanced piston rod

∅	D1 ∅	D2	H1	L4
[mm]				
32	13	M3	57.5	14
40	13	M3	64	17
50	20	M5	78.5	18
63	20	M5	84.5	25
80	30	M5	105	22
100	30	M5	113.5	25.5

E3 – End-position locking with retracted piston rod

∅	D1 ∅	D2	H1	L5
[mm]				
32	13	M3	57.5	14
40	13	M3	64	17
50	20	M5	78.5	18
63	20	M5	84.5	25
80	30	M5	105	22
100	30	M5	113.5	25.5

Standards-based cylinders DSBC, to ISO 15552

Technical data

Dimensions – Variants

Download CAD data → www.festo.com

P2 – Bellows on bearing cap

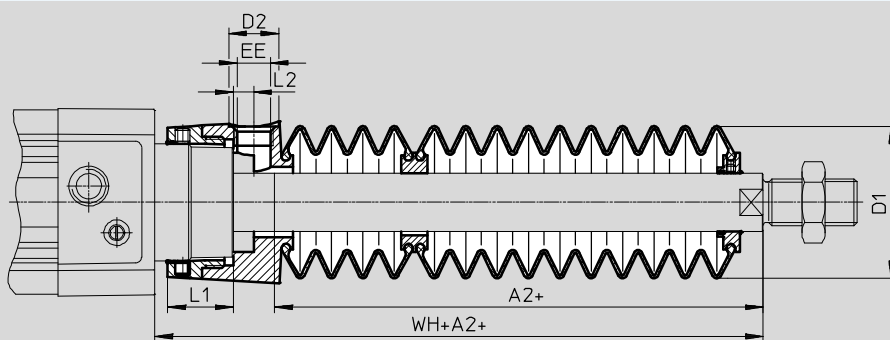

+ = plus stroke length

Ø Stroke [mm]	32							40						
	A2 ¹⁾	D1 Max.	D2	EE	L1	L2	WH+A2	A2 ¹⁾	D1 Max.	D2	EE	L1	L2	WH+A2
10 ... 50	29	38	14	G ¹ / ₈	12.9	5.4	55	28	46	14	G ¹ / ₈	16.3	5.4	56.7
51 ... 125	47						73	43						71.7
126 ... 175	61						87	56						84.7
176 ... 250	80						106	72						100.7
251 ... 300	96						122	86						114.7
301 ... 350	112						138	100						128.7
351 ... 375	114						140	101						129.7
376 ... 425	130						156	115						143.7
426 ... 475	145						171	130						158.7
476 ... 500	147						173	131						159.7

Ø Stroke [mm]	50							63						
	A2 ¹⁾	D1 Max.	D2	EE	L1	L2	WH+A2	A2 ¹⁾	D1 Max.	D2	EE	L1	L2	WH+A2
10 ... 50	28	57	17	G ¹ / ₄	22.35	7	63.6	28	57	17	G ¹ / ₄	22.4	7	63.9
51 ... 125	46						81.6	46						81.9
126 ... 175	56						91.6	56						91.9
176 ... 250	73						108.6	73						108.9
251 ... 300	86						121.6	86						121.9
301 ... 350	97						132.6	97						132.9
351 ... 375	105						140.6	105						140.9
376 ... 425	116						151.6	116						151.9
426 ... 475	126						161.6	126						161.9
476 ... 500	134						169.6	134						169.9

1) The dimension corresponds to the E value (piston rod extension) of the drive

Standards-based cylinders DSBC, to ISO 15552

Technical data

Ø Stroke [mm]	80							100						
	A2 ¹⁾	D1 Max.	D2	EE	L1	L2	WH+A2	A2 ¹⁾	D1 Max.	D2	EE	L1	L2	WH+A2
10 ... 50	25	93	17	G¼	28	4	70.4	25	93	17	G¼	28	4	74.3
51 ... 125	37						82.4	37						86.3
126 ... 175	49						94.4	49						98.3
176 ... 250	62						107.4	62						111.3
251 ... 300	74						119.4	74						123.3
301 ... 350	86						131.4	86						135.3
351 ... 375	87						132.4	87						136.3
376 ... 425	98						143.4	98						147.3
426 ... 475	110						155.4	110						159.3
476 ... 500	111						156.4	111						160.3

1) The dimension corresponds to the E value (piston rod extension) of the drive

Standards-based cylinders DSBC, to ISO 15552

FESTO

Technical data

Ordering data – Stock items					
Piston Ø [mm]	Stroke [mm]	With PPV cushioning		With PPS cushioning	
		Part No.	Type	Part No.	Type
32	20	2123069	DSBC-32-20-PPVA-N3	2123085	DSBC-32-20-PPSA-N3
	25	1376422	DSBC-32-25-PPVA-N3	1376467	DSBC-32-25-PPSA-N3
	30	2123070	DSBC-32-30-PPVA-N3	2123086	DSBC-32-30-PPSA-N3
	40	1376423	DSBC-32-40-PPVA-N3	1376468	DSBC-32-40-PPSA-N3
	50	1376424	DSBC-32-50-PPVA-N3	1376469	DSBC-32-50-PPSA-N3
	60	2123071	DSBC-32-60-PPVA-N3	2123087	DSBC-32-60-PPSA-N3
	70	2123072	DSBC-32-70-PPVA-N3	2123088	DSBC-32-70-PPSA-N3
	80	1376425	DSBC-32-80-PPVA-N3	1376470	DSBC-32-80-PPSA-N3
	100	1376426	DSBC-32-100-PPVA-N3	1376471	DSBC-32-100-PPSA-N3
	125	1376427	DSBC-32-125-PPVA-N3	1376472	DSBC-32-125-PPSA-N3
	150	2123073	DSBC-32-150-PPVA-N3	2123089	DSBC-32-150-PPSA-N3
	160	1376428	DSBC-32-160-PPVA-N3	1376473	DSBC-32-160-PPSA-N3
	200	1376429	DSBC-32-200-PPVA-N3	1376474	DSBC-32-200-PPSA-N3
	250	1376430	DSBC-32-250-PPVA-N3	1376475	DSBC-32-250-PPSA-N3
	300	2123074	DSBC-32-300-PPVA-N3	2123090	DSBC-32-300-PPSA-N3
	320	1376431	DSBC-32-320-PPVA-N3	1376476	DSBC-32-320-PPSA-N3
	400	1376432	DSBC-32-400-PPVA-N3	1376477	DSBC-32-400-PPSA-N3
	500	1376433	DSBC-32-500-PPVA-N3	1376478	DSBC-32-500-PPSA-N3
1 ... 2800	1463254	DSBC-32-...-PPVA-N3	1463252	DSBC-32-...-PPSA-N3	
40	20	2123166	DSBC-40-20-PPVA-N3	2123780	DSBC-40-20-PPSA-N3
	25	1376656	DSBC-40-25-PPVA-N3	1376903	DSBC-40-25-PPSA-N3
	30	2123167	DSBC-40-30-PPVA-N3	2123781	DSBC-40-30-PPSA-N3
	40	1376657	DSBC-40-40-PPVA-N3	1376904	DSBC-40-40-PPSA-N3
	50	1376658	DSBC-40-50-PPVA-N3	1376905	DSBC-40-50-PPSA-N3
	60	2123224	DSBC-40-60-PPVA-N3	2123782	DSBC-40-60-PPSA-N3
	70	2123225	DSBC-40-70-PPVA-N3	2123783	DSBC-40-70-PPSA-N3
	80	1376659	DSBC-40-80-PPVA-N3	1376906	DSBC-40-80-PPSA-N3
	100	1376660	DSBC-40-100-PPVA-N3	1376907	DSBC-40-100-PPSA-N3
	125	1376661	DSBC-40-125-PPVA-N3	1376908	DSBC-40-125-PPSA-N3
	150	2123226	DSBC-40-150-PPVA-N3	2123784	DSBC-40-150-PPSA-N3
	160	1376662	DSBC-40-160-PPVA-N3	1376909	DSBC-40-160-PPSA-N3
	200	1376663	DSBC-40-200-PPVA-N3	1376910	DSBC-40-200-PPSA-N3
	250	1376664	DSBC-40-250-PPVA-N3	1376911	DSBC-40-250-PPSA-N3
	300	2123227	DSBC-40-300-PPVA-N3	2123785	DSBC-40-300-PPSA-N3
	320	1376665	DSBC-40-320-PPVA-N3	1376912	DSBC-40-320-PPSA-N3
	400	1376666	DSBC-40-400-PPVA-N3	1376913	DSBC-40-400-PPSA-N3
	500	1376667	DSBC-40-500-PPVA-N3	1376914	DSBC-40-500-PPSA-N3
1 ... 2800	1462834	DSBC-40-...-PPVA-N3	1462835	DSBC-40-...-PPSA-N3	

-  - Note
Other variants in the modular product system → 32

Standards-based cylinders DSBC, to ISO 15552

Technical data

Ordering data – Stock items					
Piston Ø [mm]	Stroke [mm]	With PPV cushioning		With PPS cushioning	
		Part No.	Type	Part No.	Type
50	20	2098969	DSBC-50-20-PPVA-N3	2102628	DSBC-50-20-PPSA-N3
	25	1366948	DSBC-50-25-PPVA-N3	1376301	DSBC-50-25-PPSA-N3
	30	2098970	DSBC-50-30-PPVA-N3	2102629	DSBC-50-30-PPSA-N3
	40	1366949	DSBC-50-40-PPVA-N3	1376304	DSBC-50-40-PPSA-N3
	50	1366950	DSBC-50-50-PPVA-N3	1376305	DSBC-50-50-PPSA-N3
	60	2098972	DSBC-50-60-PPVA-N3	2102630	DSBC-50-60-PPSA-N3
	70	2098973	DSBC-50-70-PPVA-N3	2102631	DSBC-50-70-PPSA-N3
	80	1366951	DSBC-50-80-PPVA-N3	1376306	DSBC-50-80-PPSA-N3
	100	1366952	DSBC-50-100-PPVA-N3	1376307	DSBC-50-100-PPSA-N3
	125	1366953	DSBC-50-125-PPVA-N3	1376308	DSBC-50-125-PPSA-N3
	150	2098974	DSBC-50-150-PPVA-N3	2102632	DSBC-50-150-PPSA-N3
	160	1366954	DSBC-50-160-PPVA-N3	1376309	DSBC-50-160-PPSA-N3
	200	1366955	DSBC-50-200-PPVA-N3	1376310	DSBC-50-200-PPSA-N3
	250	1366956	DSBC-50-250-PPVA-N3	1376311	DSBC-50-250-PPSA-N3
	300	2098975	DSBC-50-300-PPVA-N3	2102633	DSBC-50-300-PPSA-N3
	320	1366957	DSBC-50-320-PPVA-N3	1376312	DSBC-50-320-PPSA-N3
	400	1366958	DSBC-50-400-PPVA-N3	1376313	DSBC-50-400-PPSA-N3
500	1366959	DSBC-50-500-PPVA-N3	1376314	DSBC-50-500-PPSA-N3	
1 ... 2800	1463766	DSBC-50-...-PPVA-N3	1463768	DSBC-50-...-PPSA-N3	
63	20	2125490	DSBC-63-20-PPVA-N3	2126684	DSBC-63-20-PPSA-N3
	25	1383578	DSBC-63-25-PPVA-N3	1383632	DSBC-63-25-PPSA-N3
	30	2125491	DSBC-63-30-PPVA-N3	2126685	DSBC-63-30-PPSA-N3
	40	1383579	DSBC-63-40-PPVA-N3	1383633	DSBC-63-40-PPSA-N3
	50	1383580	DSBC-63-50-PPVA-N3	1383634	DSBC-63-50-PPSA-N3
	60	2125492	DSBC-63-60-PPVA-N3	2126686	DSBC-63-60-PPSA-N3
	70	2125493	DSBC-63-70-PPVA-N3	2126687	DSBC-63-70-PPSA-N3
	80	1383581	DSBC-63-80-PPVA-N3	1383635	DSBC-63-80-PPSA-N3
	100	1383582	DSBC-63-100-PPVA-N3	1383636	DSBC-63-100-PPSA-N3
	125	1383583	DSBC-63-125-PPVA-N3	1383637	DSBC-63-125-PPSA-N3
	150	2125494	DSBC-63-150-PPVA-N3	2126688	DSBC-63-150-PPSA-N3
	160	1383584	DSBC-63-160-PPVA-N3	1383638	DSBC-63-160-PPSA-N3
	200	1383585	DSBC-63-200-PPVA-N3	1383639	DSBC-63-200-PPSA-N3
	250	1383586	DSBC-63-250-PPVA-N3	1383640	DSBC-63-250-PPSA-N3
	300	2125495	DSBC-63-300-PPVA-N3	2126689	DSBC-63-300-PPSA-N3
	320	1383587	DSBC-63-320-PPVA-N3	1383641	DSBC-63-320-PPSA-N3
	400	1383588	DSBC-63-400-PPVA-N3	1383642	DSBC-63-400-PPSA-N3
500	1383589	DSBC-63-500-PPVA-N3	1383643	DSBC-63-500-PPSA-N3	
1 ... 2800	1463483	DSBC-63-...-PPVA-N3	1463481	DSBC-63-...-PPSA-N3	

 Note
Other variants in the modular product system → 32

Standards-based cylinders DSBC, to ISO 15552

Technical data

Ordering data – Stock items					
Piston Ø [mm]	Stroke [mm]	With PPV cushioning		With PPS cushioning	
		Part No.	Type	Part No.	Type
80	20	2126594	DSBC-80-20-PPVA-N3	2126636	DSBC-80-20-PPSA-N3
	25	1383333	DSBC-80-25-PPVA-N3	1383366	DSBC-80-25-PPSA-N3
	30	2126595	DSBC-80-30-PPVA-N3	2126637	DSBC-80-30-PPSA-N3
	40	1383334	DSBC-80-40-PPVA-N3	1383367	DSBC-80-40-PPSA-N3
	50	1383335	DSBC-80-50-PPVA-N3	1383368	DSBC-80-50-PPSA-N3
	60	2126597	DSBC-80-60-PPVA-N3	2126638	DSBC-80-60-PPSA-N3
	70	2126598	DSBC-80-70-PPVA-N3	2126639	DSBC-80-70-PPSA-N3
	80	1383336	DSBC-80-80-PPVA-N3	1383369	DSBC-80-80-PPSA-N3
	100	1383337	DSBC-80-100-PPVA-N3	1383370	DSBC-80-100-PPSA-N3
	125	1383338	DSBC-80-125-PPVA-N3	1383371	DSBC-80-125-PPSA-N3
	150	2126599	DSBC-80-150-PPVA-N3	2126640	DSBC-80-150-PPSA-N3
	160	1383339	DSBC-80-160-PPVA-N3	1383372	DSBC-80-160-PPSA-N3
	200	1383340	DSBC-80-200-PPVA-N3	1383373	DSBC-80-200-PPSA-N3
	250	1383341	DSBC-80-250-PPVA-N3	1383374	DSBC-80-250-PPSA-N3
	300	2126600	DSBC-80-300-PPVA-N3	2126641	DSBC-80-300-PPSA-N3
	320	1383342	DSBC-80-320-PPVA-N3	1383375	DSBC-80-320-PPSA-N3
400	1383343	DSBC-80-400-PPVA-N3	1383376	DSBC-80-400-PPSA-N3	
500	1383344	DSBC-80-500-PPVA-N3	1383377	DSBC-80-500-PPSA-N3	
1 ... 2800	1463504	DSBC-80-...-PPVA-N3	1463500	DSBC-80-...-PPSA-N3	
100	25	1384804	DSBC-100-25-PPVA-N3	1384890	DSBC-100-25-PPSA-N3
	40	1384805	DSBC-100-40-PPVA-N3	1384891	DSBC-100-40-PPSA-N3
	50	1384806	DSBC-100-50-PPVA-N3	1384892	DSBC-100-50-PPSA-N3
	80	1384807	DSBC-100-80-PPVA-N3	1384893	DSBC-100-80-PPSA-N3
	100	1384808	DSBC-100-100-PPVA-N3	1384894	DSBC-100-100-PPSA-N3
	125	1384809	DSBC-100-125-PPVA-N3	1384895	DSBC-100-125-PPSA-N3
	160	1384810	DSBC-100-160-PPVA-N3	1384896	DSBC-100-160-PPSA-N3
	200	1384811	DSBC-100-200-PPVA-N3	1384897	DSBC-100-200-PPSA-N3
	250	1384812	DSBC-100-250-PPVA-N3	1384898	DSBC-100-250-PPSA-N3
	320	1384813	DSBC-100-320-PPVA-N3	1384899	DSBC-100-320-PPSA-N3
	400	1384814	DSBC-100-400-PPVA-N3	1384900	DSBC-100-400-PPSA-N3
	500	1384815	DSBC-100-500-PPVA-N3	1384901	DSBC-100-500-PPSA-N3
	1 ... 2800	1463598	DSBC-100-...-PPVA-N3	1463558	DSBC-100-...-PPSA-N3

 - Note
Other variants in the modular product system → 32

Standards-based cylinders DSBC, to ISO 15552

Technical data

Ordering data – Stock items					
Piston Ø [mm]	Stroke [mm]	With PPV cushioning		With PPS cushioning	
		Part No.	Type	Part No.	Type
125	25	1804956	DSBC-125-25-PPVA-N3	1804661	DSBC-125-25-PPSA-N3
	40	1804957	DSBC-125-40-PPVA-N3	1804662	DSBC-125-40-PPSA-N3
	50	1804958	DSBC-125-50-PPVA-N3	1804663	DSBC-125-50-PPSA-N3
	80	1804959	DSBC-125-80-PPVA-N3	1804664	DSBC-125-80-PPSA-N3
	100	1804960	DSBC-125-100-PPVA-N3	1804665	DSBC-125-100-PPSA-N3
	125	1804961	DSBC-125-125-PPVA-N3	1804666	DSBC-125-125-PPSA-N3
	160	1804962	DSBC-125-160-PPVA-N3	1804667	DSBC-125-160-PPSA-N3
	200	1804963	DSBC-125-200-PPVA-N3	1804668	DSBC-125-200-PPSA-N3
	250	1804964	DSBC-125-250-PPVA-N3	1804669	DSBC-125-250-PPSA-N3
	320	1804965	DSBC-125-320-PPVA-N3	1804671	DSBC-125-320-PPSA-N3
	400	1804966	DSBC-125-400-PPVA-N3	1804672	DSBC-125-400-PPSA-N3
	500	1804967	DSBC-125-500-PPVA-N3	1804673	DSBC-125-500-PPSA-N3
	1 ... 2800	1755348	DSBC-125-...-PPVA-N3	1755619	DSBC-125-...-PPSA-N3

 Note
Other variants in the modular product system → 32

Standards-based cylinders DSBC, to ISO 15552

Ordering data – Modular product system

Ordering table											
Size	32	40	50	63	80	100	125	Conditions	Code	Entry code	
M Module no.	1463250	1461995	1463770	1463475	1463495	1463520	1722457				
Function	Standards-based cylinder, double-acting, based on ISO 15552								DSBC	DSBC	
O Protection against rotation	None										
	With protection against rotation							-	1	-Q	
Running characteristics	Standard										
	Low friction							-	2	L	
	Constant, slow movement								2	U	
	Low friction for balancer applications								3	L1	
M Piston Ø [mm]	32	40	50	63	80	100	125		-...		
Stroke [mm]	1 ... 2800									-...	
O Piston rod type	Piston rod at one end										
	Through piston rod									-T	
Piston rod thread type	Male thread										
	Female thread								4	F	
Profile type	Sensor slot on 1 side										
	Sensor slot on 3 sides									D3	
M Cushioning	Elastic cushioning rings/pads at both ends								5	-P	
	Pneumatic cushioning, self-adjusting at both ends								6	-PPS	
	Pneumatic cushioning, adjustable at both ends									-PPV	
↓ Position sensing	Via proximity sensor									A	A

- 1 Q** Not with L, U, L1, N3, T3, T4, P2, A1, A2, A3, A6
Only up to a stroke of 1500 mm
- 2 L, U** Not with T, R3, T1, T3, T4, P2, A1, A2, A3, A6, EX4
- 3 L1** Not with T, PPV, R3, T1, T3, T4, P2, A1, A2, A3, A6, EX4
- 4 F** Not with ...L
- 5 P** Not with A1
- 6 PPS** Not with T1, T3, T4, A1

 Note

If feature L is used in combination with transverse loads or strokes of above 500 mm, suitable measures must be taken to support the piston rod.
The operating pressure (➔ 13) is applicable for strokes up to 500 mm.

 Note

If feature L1 is used in combination with strokes of above 500 mm, suitable measures must be taken to support the piston rod.
The operating pressure (➔ 13) is applicable for strokes up to 500 mm.

- M** Mandatory data
- O** Options

Transfer order code

DSBC - - - - - **A**

Standards-based cylinders DSBC, to ISO 15552

Ordering data – Modular products

Ordering table										
Size	32	40	50	63	80	100	125	Conditions	Code	Entry code
Standard	Based on ISO 15552									
	Corresponds to ISO 15552								-N3	
Corrosion protection	Standard									
	High corrosion protection							<input type="checkbox"/>	R3	
Temperature range	Standard									
	[°C]	Heat-resistant seals up to max. 120						<input type="checkbox"/>	T1	
	[°C]	-40 ... +80						<input type="checkbox"/>	T3	
	[°C]	0 ... +150						<input type="checkbox"/>	T4	
Protection against particles	Standard									
	Bellows on bearing cap						-	<input type="checkbox"/>	P2	
Scraper variant	None									
	Increased chemical resistance								<input type="checkbox"/>	A1
	Hard scraper								<input type="checkbox"/>	A2
	For unlubricated operation								<input type="checkbox"/>	A3
	Metal scraper								<input type="checkbox"/>	A6
EU certification	None									
	[mm]	II 2GD						<input type="checkbox"/>	EX4	
Piston rod extension	None									
	[mm]	1 ... 500						<input type="checkbox"/>	-...E	
Piston rod thread extension	None									
	[mm]	1 ... 35		1 ... 70				<input type="checkbox"/>	-...L	

- R3** Not with A2, A6
- T1, T3, T4** Not with P2, A1, A2, A3, EX4
- P2** Not with N3, A1, A2, A3, A6, EX4
Only for strokes of 10 ... 500 mm
- EX4** Not with T1, T3, T4, P2, A1, A3, A6
- ...E, ...L** Only up to a stroke of 2000 mm

 - Note
The piston rod extension for the bellows is automatically taken into consideration when feature P2 is selected. This means that there is no need to specify a value for feature ...E.

 - Note
When selecting feature ...E in combination with feature P2, the part of the piston rod extension ...E is not covered by the bellows.

 - Note
When feature P2 is selected in combination with feature T (through piston rod), the bellows is mounted on one side only.

- M** Mandatory data
- O** Options

Transfer order code

- - -

Standards-based cylinders DSBC, standard hole pattern, with clamping unit



Ordering data – Modular products

Ordering table											
Size	32	40	50	63	80	100	125	Conditions	Code	Entry code	
M Module no.	1463250	1461995	1463770	1463475	1463495	1463520	1722457				
Function	Standards-based cylinder, double-acting, based on ISO 15552								DSBC	DSBC	
O Protection against rotation	None										
	With protection against rotation							-	¹	-Q	
M Piston Ø [mm]	32	40	50	63	80	100	125		-...		
Stroke [mm]	10 ... 2000									-...	
O Clamping unit	Attached									-C	C
Piston rod type	Piston rod at one end										
	Through piston rod									T	
Piston rod thread type	Male thread										
	Female thread								²	F	
Profile type	Sensor slot on 1 side										
	Sensor slot on 3 sides									D3	
M Cushioning	Elastic cushioning rings/pads at both ends									-P	
	Pneumatic cushioning, self-adjusting at both ends									-PPS	
	Pneumatic cushioning, adjustable at both ends									-PPV	
Position sensing	Via proximity sensor									A	A
Piston rod extension [mm]	None										
	1 ... 500									-...E	
Piston rod thread extension [mm]	None										
	1 ... 35		1 ... 70							-...L	

- ¹ **Q** Only available with T
Only up to stroke 1500 mm
- ² **F** Not with ...L

- M** Mandatory data
- O** Options

Transfer order code

- - - -

 -

 - -

Standards-based cylinders DSBC, standard hole pattern, with end-position locking **FESTO**

Ordering data – Modular products

Ordering table									
Size	32	40	50	63	80	100	Conditions	Code	Entry code
M Module no.	1463250	1461995	1463770	1463475	1463495	1463520			
Function	Standards-based cylinder, double-acting, based on ISO 15552							DSBC	DSBC
Piston Ø [mm]	32	40	50	63	80	100		-...	
Stroke [mm]	10 ... 2000								-...
O End-position locking	None								
	At both ends							E1	
	With piston rod in advanced position							E2	
	With piston rod in retracted position							E3	
Piston rod thread type	Male thread								
	Female thread						1	F	
Profile type	Sensor slot on 1 side								
	Sensor slot on 3 sides							D3	
M Cushioning	Elastic cushioning rings/pads at both ends							-P	
	Pneumatic cushioning, adjustable at both ends							-PPV	
Position sensing	Via proximity sensor							A	A
Piston rod extension [mm]	None								
	1 ... 500							-...E	
Piston rod thread extension [mm]	None								
	1 ... 35		1 ... 70					-...L	

1 F Not with ...L

M Mandatory data

O Options

Transfer order code

DSBC - - - **A** - -

Standards-based cylinders DSBC, to ISO 15552

Technical data

FESTO

Ordering data – Versions for DSBC-...-D3 (sensor slots on 3 sides)

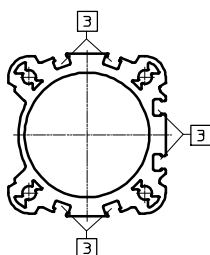

In this version, the piston position can be sensed on 3 sides of the drive.

3 Slot for proximity sensor

Piston Ø [mm]	Stroke [mm]	With PPV cushioning		With PPS cushioning	
		Part No.	Type	Part No.	Type
32	20	3656511	DSBC-32-20-D3-PPVA-N3	3659374	DSBC-32-20-D3-PPSA-N3
	25	3656512	DSBC-32-25-D3-PPVA-N3	3659375	DSBC-32-25-D3-PPSA-N3
	30	3656513	DSBC-32-30-D3-PPVA-N3	3659376	DSBC-32-30-D3-PPSA-N3
	40	3656514	DSBC-32-40-D3-PPVA-N3	3659377	DSBC-32-40-D3-PPSA-N3
	50	3656515	DSBC-32-50-D3-PPVA-N3	3659378	DSBC-32-50-D3-PPSA-N3
	60	3656516	DSBC-32-60-D3-PPVA-N3	3659379	DSBC-32-60-D3-PPSA-N3
	70	3656517	DSBC-32-70-D3-PPVA-N3	3659380	DSBC-32-70-D3-PPSA-N3
	80	3656518	DSBC-32-80-D3-PPVA-N3	3659381	DSBC-32-80-D3-PPSA-N3
	100	3656519	DSBC-32-100-D3-PPVA-N3	3659382	DSBC-32-100-D3-PPSA-N3
	125	3656520	DSBC-32-125-D3-PPVA-N3	3659383	DSBC-32-125-D3-PPSA-N3
	150	3656521	DSBC-32-150-D3-PPVA-N3	3659384	DSBC-32-150-D3-PPSA-N3
	160	3656522	DSBC-32-160-D3-PPVA-N3	3659385	DSBC-32-160-D3-PPSA-N3
	200	3656523	DSBC-32-200-D3-PPVA-N3	3659386	DSBC-32-200-D3-PPSA-N3
	250	3656524	DSBC-32-250-D3-PPVA-N3	3659387	DSBC-32-250-D3-PPSA-N3
	300	3656525	DSBC-32-300-D3-PPVA-N3	3659388	DSBC-32-300-D3-PPSA-N3
	320	3656526	DSBC-32-320-D3-PPVA-N3	3659389	DSBC-32-320-D3-PPSA-N3
40	20	3660615	DSBC-40-20-D3-PPVA-N3	3660759	DSBC-40-20-D3-PPSA-N3
	25	3660616	DSBC-40-25-D3-PPVA-N3	3660760	DSBC-40-25-D3-PPSA-N3
	30	3660617	DSBC-40-30-D3-PPVA-N3	3660761	DSBC-40-30-D3-PPSA-N3
	40	3660618	DSBC-40-40-D3-PPVA-N3	3660762	DSBC-40-40-D3-PPSA-N3
	50	3660619	DSBC-40-50-D3-PPVA-N3	3660763	DSBC-40-50-D3-PPSA-N3
	60	3660620	DSBC-40-60-D3-PPVA-N3	3660764	DSBC-40-60-D3-PPSA-N3
	70	3660621	DSBC-40-70-D3-PPVA-N3	3660765	DSBC-40-70-D3-PPSA-N3
	80	3660622	DSBC-40-80-D3-PPVA-N3	3660766	DSBC-40-80-D3-PPSA-N3
	100	3660623	DSBC-40-100-D3-PPVA-N3	3660767	DSBC-40-100-D3-PPSA-N3
	125	3660624	DSBC-40-125-D3-PPVA-N3	3660768	DSBC-40-125-D3-PPSA-N3
	150	3660625	DSBC-40-150-D3-PPVA-N3	3660769	DSBC-40-150-D3-PPSA-N3
	160	3660626	DSBC-40-160-D3-PPVA-N3	3660770	DSBC-40-160-D3-PPSA-N3
	200	3660627	DSBC-40-200-D3-PPVA-N3	3660771	DSBC-40-200-D3-PPSA-N3
	250	3660628	DSBC-40-250-D3-PPVA-N3	3660772	DSBC-40-250-D3-PPSA-N3
	300	3660629	DSBC-40-300-D3-PPVA-N3	3660773	DSBC-40-300-D3-PPSA-N3
	320	3660630	DSBC-40-320-D3-PPVA-N3	3660774	DSBC-40-320-D3-PPSA-N3

Standards-based cylinders DSBC, to ISO 15552

Technical data

Ordering data – Versions for DSBC-...-D3 (sensor slots on 3 sides)

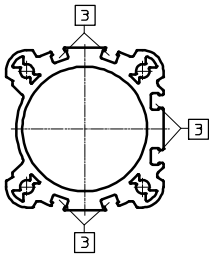

In this version, the piston position can be sensed on 3 sides of the drive.

3 Slot for proximity sensor

Piston Ø [mm]	Stroke [mm]	With PPV cushioning		With PPS cushioning	
		Part No.	Type	Part No.	Type
50	20	3659467	DSBC-50-20-D3-PPVA-N3	3659491	DSBC-50-20-D3-PPSA-N3
	25	3659468	DSBC-50-25-D3-PPVA-N3	3659492	DSBC-50-25-D3-PPSA-N3
	30	3659469	DSBC-50-30-D3-PPVA-N3	3659493	DSBC-50-30-D3-PPSA-N3
	40	3659470	DSBC-50-40-D3-PPVA-N3	3659494	DSBC-50-40-D3-PPSA-N3
	50	3659471	DSBC-50-50-D3-PPVA-N3	3659495	DSBC-50-50-D3-PPSA-N3
	60	3659472	DSBC-50-60-D3-PPVA-N3	3659496	DSBC-50-60-D3-PPSA-N3
	70	3659473	DSBC-50-70-D3-PPVA-N3	3659497	DSBC-50-70-D3-PPSA-N3
	80	3659474	DSBC-50-80-D3-PPVA-N3	3659498	DSBC-50-80-D3-PPSA-N3
	100	3659475	DSBC-50-100-D3-PPVA-N3	3659499	DSBC-50-100-D3-PPSA-N3
	125	3659476	DSBC-50-125-D3-PPVA-N3	3659500	DSBC-50-125-D3-PPSA-N3
	150	3659477	DSBC-50-150-D3-PPVA-N3	3659501	DSBC-50-150-D3-PPSA-N3
	160	3659478	DSBC-50-160-D3-PPVA-N3	3659502	DSBC-50-160-D3-PPSA-N3
	200	3659479	DSBC-50-200-D3-PPVA-N3	3659503	DSBC-50-200-D3-PPSA-N3
	250	3659480	DSBC-50-250-D3-PPVA-N3	3659504	DSBC-50-250-D3-PPSA-N3
	300	3659481	DSBC-50-300-D3-PPVA-N3	3659505	DSBC-50-300-D3-PPSA-N3
320	3659482	DSBC-50-320-D3-PPVA-N3	3659506	DSBC-50-320-D3-PPSA-N3	
63	20	3657859	DSBC-63-20-D3-PPVA-N3	3657811	DSBC-63-20-D3-PPSA-N3
	25	3657860	DSBC-63-25-D3-PPVA-N3	3657812	DSBC-63-25-D3-PPSA-N3
	30	3657861	DSBC-63-30-D3-PPVA-N3	3657813	DSBC-63-30-D3-PPSA-N3
	40	3657862	DSBC-63-40-D3-PPVA-N3	3657814	DSBC-63-40-D3-PPSA-N3
	50	3657863	DSBC-63-50-D3-PPVA-N3	3657815	DSBC-63-50-D3-PPSA-N3
	60	3657864	DSBC-63-60-D3-PPVA-N3	3657816	DSBC-63-60-D3-PPSA-N3
	70	3657865	DSBC-63-70-D3-PPVA-N3	3657817	DSBC-63-70-D3-PPSA-N3
	80	3657866	DSBC-63-80-D3-PPVA-N3	3657818	DSBC-63-80-D3-PPSA-N3
	100	3657867	DSBC-63-100-D3-PPVA-N3	3657819	DSBC-63-100-D3-PPSA-N3
	125	3657868	DSBC-63-125-D3-PPVA-N3	3657820	DSBC-63-125-D3-PPSA-N3
	150	3657869	DSBC-63-150-D3-PPVA-N3	3657821	DSBC-63-150-D3-PPSA-N3
	160	3657870	DSBC-63-160-D3-PPVA-N3	3657822	DSBC-63-160-D3-PPSA-N3
	200	3657871	DSBC-63-200-D3-PPVA-N3	3657823	DSBC-63-200-D3-PPSA-N3
	250	3657872	DSBC-63-250-D3-PPVA-N3	3657824	DSBC-63-250-D3-PPSA-N3
	300	3657873	DSBC-63-300-D3-PPVA-N3	3657825	DSBC-63-300-D3-PPSA-N3
320	3657874	DSBC-63-320-D3-PPVA-N3	3657826	DSBC-63-320-D3-PPSA-N3	

Standards-based cylinders DSBC, to ISO 15552

Technical data

FESTO

Ordering data – Versions for DSBC-...-D3 (sensor slots on 3 sides)

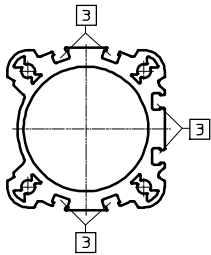

In this version, the piston position can be sensed on 3 sides of the drive.

3 Slot for proximity sensor

Piston Ø [mm]	Stroke [mm]	With PPV cushioning		With PPS cushioning	
		Part No.	Type	Part No.	Type
80	20	3656631	DSBC-80-20-D3-PPVA-N3	3656854	DSBC-80-20-D3-PPSA-N3
	25	3656632	DSBC-80-25-D3-PPVA-N3	3656855	DSBC-80-25-D3-PPSA-N3
	30	3656633	DSBC-80-30-D3-PPVA-N3	3656856	DSBC-80-30-D3-PPSA-N3
	40	3656634	DSBC-80-40-D3-PPVA-N3	3656857	DSBC-80-40-D3-PPSA-N3
	50	3656635	DSBC-80-50-D3-PPVA-N3	3656858	DSBC-80-50-D3-PPSA-N3
	60	3656636	DSBC-80-60-D3-PPVA-N3	3656859	DSBC-80-60-D3-PPSA-N3
	70	3656637	DSBC-80-70-D3-PPVA-N3	3656860	DSBC-80-70-D3-PPSA-N3
	80	3656638	DSBC-80-80-D3-PPVA-N3	3656861	DSBC-80-80-D3-PPSA-N3
	100	3656639	DSBC-80-100-D3-PPVA-N3	3656862	DSBC-80-100-D3-PPSA-N3
	125	3656640	DSBC-80-125-D3-PPVA-N3	3656863	DSBC-80-125-D3-PPSA-N3
	150	3656641	DSBC-80-150-D3-PPVA-N3	3656864	DSBC-80-150-D3-PPSA-N3
	160	3656642	DSBC-80-160-D3-PPVA-N3	3656865	DSBC-80-160-D3-PPSA-N3
	200	3656643	DSBC-80-200-D3-PPVA-N3	3656866	DSBC-80-200-D3-PPSA-N3
	250	3656644	DSBC-80-250-D3-PPVA-N3	3656867	DSBC-80-250-D3-PPSA-N3
	300	3656645	DSBC-80-300-D3-PPVA-N3	3656868	DSBC-80-300-D3-PPSA-N3
	320	3656646	DSBC-80-320-D3-PPVA-N3	3656869	DSBC-80-320-D3-PPSA-N3

Standards-based cylinders DSBC, to ISO 15552

Accessories

Foot mounting HNC/CRHNC

Materials:

- HNC: Galvanised steel
- CRHNC: High-alloy steel
- Free of copper and PTFE

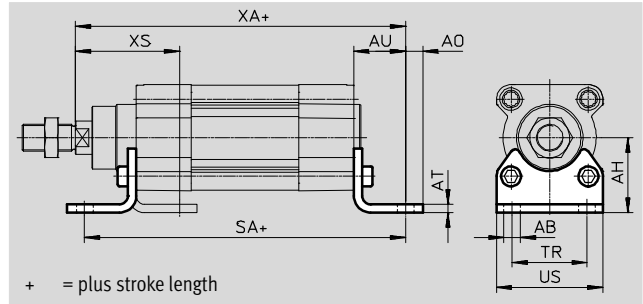

Dimensions and ordering data												
For Ø [mm]	AB Ø	AH	AO	AT	AU	SA		TR	US	XA		XS
						DSBC-...	DSBC-...-C			DSBC-...	DSBC-...-C	
32	7	32	6.5	4	24	142	187	32	45	143.1	188.1	46
40	10	36	9	4	28	161	214	36	54	161.9	214.9	52.7
50	10	45	9.5	5	32	170	237	45	64	173.8	240.8	62.6
63	10	50	12.5	5	32	185	261	50	75	189.1	265.1	62.9
80	12	63	15	6	41	210	305	63	93	214.6	309.6	80.4
100	14.5	71	17.5	6	41	220	318	75	110	228.5	326.7	84.3
125	16.5	90	22	8	45	250	375	90	131	270	394.3	102

For Ø [mm]	Basic design				Corrosion resistant			
	CRC ¹⁾	Weight [g]	Part No.	Type ²⁾	CRC ¹⁾	Weight [g]	Part No.	Type ²⁾
32	2	144	174369	HNC-32	4	139	176937	CRHNC-32
40	2	193	174370	HNC-40	4	188	176938	CRHNC-40
50	2	353	174371	HNC-50	4	341	176939	CRHNC-50
63	2	436	174372	HNC-63	4	424	176940	CRHNC-63
80	2	829	174373	HNC-80	4	809	176941	CRHNC-80
100	2	1009	174374	HNC-100	4	990	176942	CRHNC-100
125	2	1902	174375	HNC-125	4	1920	176943	CRHNC-125

- 1) Corrosion resistance class CRC 2 to Festo standard FN 940070
Moderate corrosion stress. Indoor applications in which condensation may occur. External visible parts with primarily decorative requirements for the surface and which are in direct contact with the ambient atmosphere typical for industrial applications.
Corrosion resistance class CRC 4 to Festo standard FN 940070
Particularly high corrosion stress. Outdoor exposure under extreme corrosive conditions. Parts exposed to aggressive media, for instance in the chemical or food industries. These applications may need to be supported by special tests (→ also FN 940082) using appropriate media.
- 2) Suitable for ATEX

Standards-based cylinders DSBC, to ISO 15552



Accessories

Flange mounting FNC/CRFNG

Materials:

FNC: Galvanised steel

CRFNG: High-alloy steel

Free of copper and PTFE

RoHS compliant

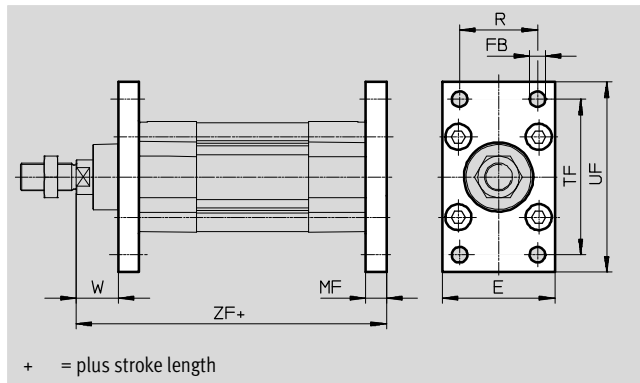

Dimensions and ordering data									
For Ø [mm]	E	FB Ø H13	MF	R	TF	UF	W	ZF	
								DSBC-...	DSBC-...-C
32	45	7	10	32	64	80	16	129.1	174.1
40	54	9	10	36	72	90	18.7	143.9	196.9
50	65	9	12	45	90	110	23.6	153.8	220.8
63	75	9	12	50	100	120	23.9	169.1	245.1
80	93	12	16	63	126	150	29.4	189.6	284.6
100	110	14	16	75	150	175	33.3	203.5	301.7
125	132	16	20	90	180	210	45	245	369.3

For Ø [mm]	Basic design				Corrosion resistant			
	CRC ¹⁾	Weight [g]	Part No.	Type ²⁾	CRC ¹⁾	Weight [g]	Part No.	Type ²⁾
32	1	221	174376	FNC-32	4	220	161846	CRFNG-32
40	1	291	174377	FNC-40	4	291	161847	CRFNG-40
50	1	536	174378	FNC-50	4	526	161848	CRFNG-50
63	1	679	174379	FNC-63	4	680	161849	CRFNG-63
80	1	1495	174380	FNC-80	4	1508	161850	CRFNG-80
100	1	2041	174381	FNC-100	4	2054	161851	CRFNG-100
125	1	3775	174382	FNC-125	4	3787	185363	CRFNG-125

1) Corrosion resistance class CRC 1 to Festo standard FN 940070

Low corrosion stress. For dry indoor applications or transport and storage protection. Also applies to parts behind covers, in the non-visible interior area, and parts which are covered in the application (e.g. drive trunnions).

Corrosion resistance class CRC 4 to Festo standard FN 940070

Particularly high corrosion stress. Outdoor exposure under extreme corrosive conditions. Parts exposed to aggressive media, for instance in the chemical or food industries. These applications may need to be supported by special tests (→ also FN 940082) using appropriate media.

2) Suitable for ATEX

Standards-based cylinders DSBC, to ISO 15552

Accessories

Trunnion flange ZNCF/CRZNG

Materials:

ZNCF: Stainless steel casting

CRZNG: Electropolished stainless steel casting

Free of copper and PTFE

RoHS compliant

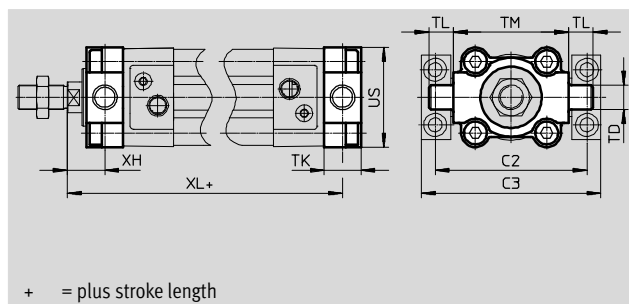

+ = plus stroke length

Dimensions and ordering data

For Ø [mm]	C2	C3	TD Ø e9	TK	TL	TM	US	XH	XL	
									DSBC-...	DSBC-...-C
32	71	86	12	16	12	50	45	18	127.1	172.1
40	87	105	16	20	16	63	54	18.7	143.9	196.9
50	99	117	16	24	16	75	64	23.6	153.8	220.8
63	116	136	20	24	20	90	75	23.9	169.1	245.1
80	136	156	20	28	20	110	93	31.4	187.6	282.6
100	164	189	25	38	25	132	110	30.3	206.5	304.7
125	192	217	25	50	25	160	131	40	250	374.3

For Ø [mm]	Basic design				High corrosion protection			
	CRC ¹⁾	Weight [g]	Part No.	Type ²⁾	CRC ¹⁾	Weight [g]	Part No.	Type ²⁾
32	2	150	174411	ZNCF-32	4	150	161852	CRZNG-32
40	2	285	174412	ZNCF-40	4	285	161853	CRZNG-40
50	2	473	174413	ZNCF-50	4	473	161854	CRZNG-50
63	2	687	174414	ZNCF-63	4	687	161855	CRZNG-63
80	2	1296	174415	ZNCF-80	4	1296	161856	CRZNG-80
100	2	2254	174416	ZNCF-100	4	2254	161857	CRZNG-100
125	2	3484	174417	ZNCF-125	4	3484	185362	CRZNG-125

1) Corrosion resistance class CRC 2 to Festo standard FN 940070

Moderate corrosion stress. Indoor applications in which condensation may occur. External visible parts with primarily decorative requirements for the surface and which are in direct contact with the ambient atmosphere typical for industrial applications.

Corrosion resistance class CRC 4 to Festo standard FN 940070

Particularly high corrosion stress. Outdoor exposure under extreme corrosive conditions. Parts exposed to aggressive media, for instance in the chemical or food industries. These applications may need to be supported by special tests (→ also FN 940082) using appropriate media.

2) Suitable for ATEX

Standards-based cylinders DSBC, to ISO 15552

Accessories



Trunnion support LNZG

Materials:

Trunnion support: Anodised aluminium

Plain bearing: Plastic

Free of copper and PTFE

RoHS compliant

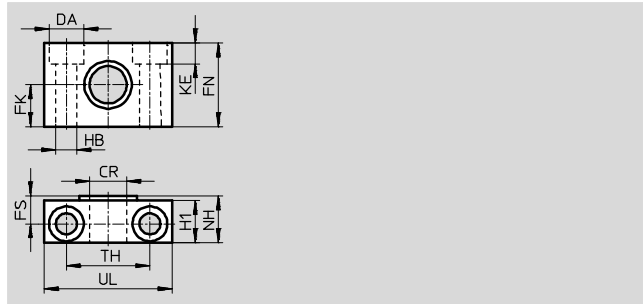
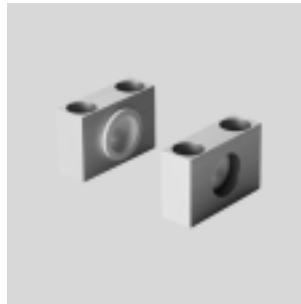

Dimensions and ordering data

For \varnothing	CR	DA	FK	FN	FS	H1	HB	KE	NH	TH	UL	CRC ¹⁾	Weight	Part No.	Type
[mm]	\varnothing	\varnothing	\varnothing				\varnothing			± 0.2			[g]		
32	12	11	15	30	10.5	15	6.6	6.8	18	32	46	2	83	32959	LNZG-32
40, 50	16	15	18	36	12	18	9	9	21	36	55	2	129	32960	LNZG-40/50
63, 80	20	18	20	40	13	20	11	11	23	42	65	2	178	32961	LNZG-63/80
100, 125	25	20	25	50	16	24.5	14	13	28.5	50	75	2	306	32962	LNZG-100/125

1) Corrosion resistance class CRC 2 to Festo standard FN 940070

Moderate corrosion stress. Indoor applications in which condensation may occur. External visible parts with primarily decorative requirements for the surface and which are in direct contact with the ambient atmosphere typical for industrial applications.

Trunnion support CRLNZG

Materials:

High-alloy steel

Free of copper and PTFE

RoHS compliant

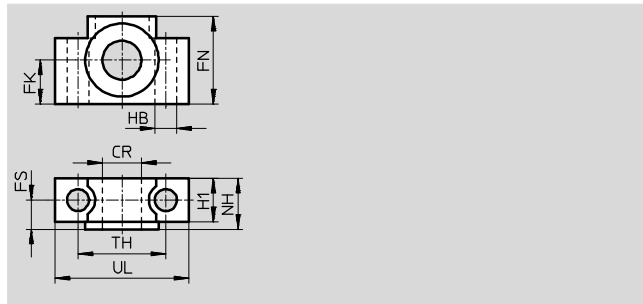
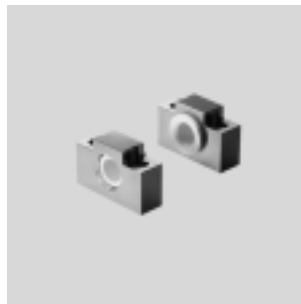

Dimensions and ordering data

For \varnothing	CR	FK	FN	FS	H1	HB	NH	TH	UL	CRC ¹⁾	Weight	Part No.	Type
[mm]	\varnothing	\varnothing				\varnothing		± 0.2			[g]		
32	12	15	30	10.5	15	6.6	18	32	46	4	205	161874	CRLNZG-32
40, 50	16	18	36	12	18	9	21	36	55	4	323	161875	CRLNZG-40/50
63, 80	20	20	40	13	20	11	23	42	65	4	435	161876	CRLNZG-63/80
100, 125	25	25	50	16	24.5	14	28.5	50	75	4	739	161877	CRLNZG-100/125

1) Corrosion resistance class CRC 4 to Festo standard FN 940070

Particularly high corrosion stress. Outdoor exposure under extreme corrosive conditions. Parts exposed to aggressive media, for instance in the chemical or food industries. These applications may need to be supported by special tests (→ also FN 940082) using appropriate media.

Standards-based cylinders DSBC, to ISO 15552

Accessories

Swivel flange SNC

Materials:
Die-cast aluminium
RoHS-compliant

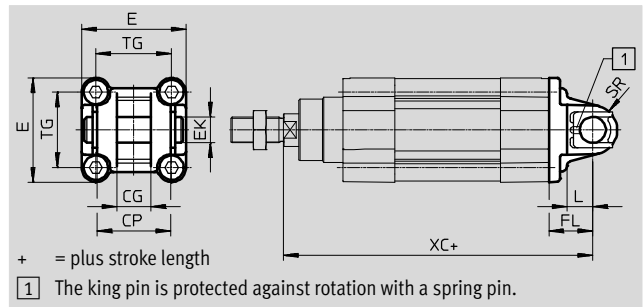

Dimensions and ordering data							
For Ø	CG	CP	E	EK	FL	L	SR
[mm]	H14	h14		Ø H9	±0.2		
32	14	34	45 ^{+0.2/-0.5}	10	22	13	10
40	16	40	54 ^{-0.5}	12	25	16	12
50	21	45	64 ^{-0.6}	16	27	16	12
63	21	51	75 ^{-0.6}	16	32	21	16
80	25	65	93 ^{-0.8}	20	36	22	16
100	25	75	110 ^{+0.3/-0.8}	20	41	27	20
125	37	97	131 ^{-0.8}	30	50	30	25

For Ø	TG	XC		CRC ¹⁾	Weight	Part No.	Type ²⁾
		DSBC...	DSBC...-C				
[mm]					[g]		
32	32.5	141.1	186.1	2	93	174383	SNC-32
40	38	158.9	211.9	2	140	174384	SNC-40
50	46.5	168.8	235.8	2	234	174385	SNC-50
63	56.5	189.1	265.1	2	331	174386	SNC-63
80	72	209.6	304.6	2	618	174387	SNC-80
100	89	228.5	326.7	2	865	174388	SNC-100
125	110	275	399.3	2	1728	174389	SNC-125

- 1) Corrosion resistance class CRC 2 to Festo standard FN 940070
Moderate corrosion stress. Indoor applications in which condensation may occur. External visible parts with primarily decorative requirements for the surface and which are in direct contact with the ambient atmosphere typical for industrial applications.
- 2) ATEX-compliant

Standards-based cylinders DSBC, to ISO 15552

FESTO

Accessories

Swivel flange SNCB/SNCB-...-R3

Materials:
 SNCB: Die-cast aluminium
 SNCB-...-R3: Die-cast aluminium with protective coating
 Free of copper and PTFE
 RoHS-compliant

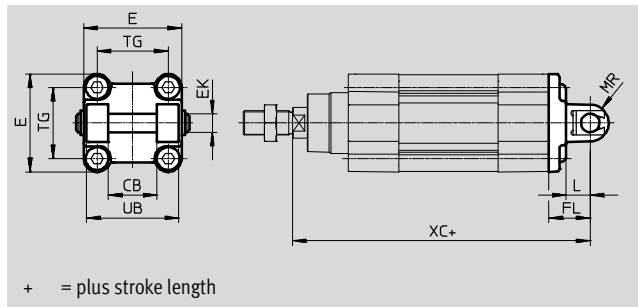

Dimensions and ordering data										
For \varnothing	CB	E	EK	FL	L	MR	TG	UB	XC	
[mm]	H14		\varnothing H9/e8	± 0.2		-0.5		h14	DSBC-...	DSBC-...-C
32	26	45 $+0.2/-0.5$	10	22	13	8.5	32.5	45	141.1	186.1
40	28	54 -0.5	12	25	16	12	38	52	158.9	211.9
50	32	64 -0.6	12	27	16	12	46.5	60	168.8	235.8
63	40	75 -0.6	16	32	21	16	56.5	70	189.1	265.1
80	50	93 -0.8	16	36	22	16	72	90	209.6	304.6
100	60	110 $+0.3/-0.8$	20	41	27	20	89	110	228.5	326.7
125	70	131 -0.8	25	50	30	25	110	130	275	399.3

For \varnothing [mm]	Basic design				R3 – High corrosion protection			
	CRC ¹⁾	Weight [g]	Part No.	Type	CRC ¹⁾	Weight [g]	Part No.	Type
32	2	103	174390	SNCB-32	3	100	176944	SNCB-32-R3
40	2	155	174391	SNCB-40	3	151	176945	SNCB-40-R3
50	2	232	174392	SNCB-50	3	228	176946	SNCB-50-R3
63	2	375	174393	SNCB-63	3	371	176947	SNCB-63-R3
80	2	636	174394	SNCB-80	3	632	176948	SNCB-80-R3
100	2	1035	174395	SNCB-100	3	986	176949	SNCB-100-R3
125	2	1860	174396	SNCB-125	3	1776	176950	SNCB-125-R3

1) Corrosion resistance class CRC 2 to Festo standard FN 940070
 Moderate corrosion stress. Indoor applications in which condensation may occur. External visible parts with primarily decorative requirements for the surface and which are in direct contact with the ambient atmosphere typical for industrial applications.
 Corrosion resistance class CRC 3 to Festo standard FN 940070
 High corrosion stress. Outdoor exposure under moderate corrosive conditions. External visible parts with primarily functional requirements for the surface and which are in direct contact with a normal industrial environment.

Standards-based cylinders DSBC, to ISO 15552

Accessories

Swivel flange

SNCS/CRSNCS/SNCS-...-R3

Materials:

SNCS 32 ... 80: Die-cast aluminium

SNCS 100 ... 125:

Wrought aluminium alloy

CRSNCS 32 ... 80:

High-alloy stainless steel

SNCS-...-R3 100 ... 125: Wrought aluminium alloy with protective coating

RoHS-compliant

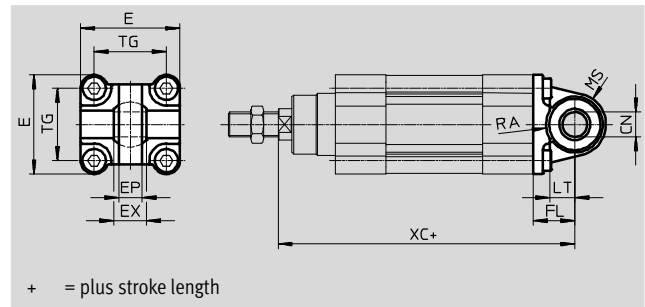
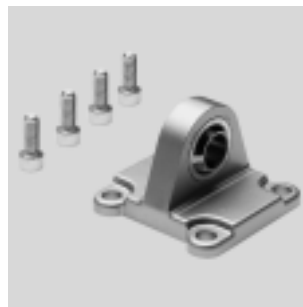

Dimensions and ordering data								
For Ø [mm]	CN Ø		E		EP ±0.2	EX	FL ±0.2	LT
	DSBC...	DSBC-...-R3	DSBC...	DSBC-...-R3				
32	10 ^{+0.013}	10 ^{+0.015/-0.04}	45 ^{+0.2/-0.5}	45 ^{-0.5}	10.5	14	22	13
40	12 ^{+0.015}	12 ^{+0.018/-0.04}	54 ^{-0.5}	54 ^{-0.5}	12	16	25	16
50	16 ^{+0.015}	16 ^{+0.018/-0.04}	64 ^{-0.6}	64 ^{-0.6}	15	21	27	16
63	16 ^{+0.015}	16 ^{+0.018/-0.04}	75 ^{-0.6}	75 ^{-0.6}	15	21	32	21
80	20 ^{+0.018}	20 ^{+0.021/-0.04}	93 ^{-0.8}	93 ^{-0.8}	18	25	36	22
100	20 ^{+0.018}	20 ^{+0.021/-0.04}	109 ^{+1/-0.7}	109 ^{+1/-0.7}	18	25	41	27
125	30 ^{+0.018}	30 ^{+0.021/-0.04}	132 ^{+1/-0.7}	132 ^{+1/-0.7}	25	37	50	30

For Ø [mm]	MS		RA		TG	XC	
	DSBC...	DSBC-...-R3	DSBC-... +1	DSBC-...-R3 +1		DSBC...	DSBC-...-C
32	15 ^{+0.5}	15 ^{+0.5}	14.5	14.5	32.5	141.1	186.1
40	17 ^{+0.5}	17 ^{+0.5}	17.5	17.5	38	158.9	211.9
50	20 ^{+0.5}	20 ^{+0.5}	18.5	19	46.5	168.8	235.8
63	23 ^{-0.5}	22 ^{+0.5}	23	23	56.5	189.1	265.1
80	28 ^{-0.5}	27 ^{+0.5}	25	25	72	209.6	304.6
100	30 ^{+0.5}	30 ^{+0.5}	95	100	89	228.5	326.7
125	39 ^{+0.5}	39 ^{+0.5}	100	100	110	275	326.7

For Ø [mm]	Basic version				High corrosion protection			
	CRC ¹⁾	Weight [g]	Part No.	Type	CRC ¹⁾	Weight [g]	Part No.	Type
32	2	86	174397	SNCS-32	4	161	2895920	CRSNCS-32
40	2	122	174398	SNCS-40	4	239	2895921	CRSNCS-40
50	2	216	174399	SNCS-50	4	403	2895922	CRSNCS-50
63	2	281	174400	SNCS-63	4	576	2895923	CRSNCS-63
80	2	557	174401	SNCS-80	4	1173	2895924	CRSNCS-80
100	2	683	174402	SNCS-100	3	684	2895925	SNCS-100-R3
125	2	1369	174403	SNCS-125	3	1369	2895926	SNCS-125-R3

1) Corrosion resistance class CRC 2 to Festo standard FN 940070

Moderate corrosion stress. Indoor applications in which condensation may occur. External visible parts with primarily decorative requirements for the surface and which are in direct contact with the ambient atmosphere typical for industrial applications.

Corrosion resistance class CRC 3 to Festo standard FN 940070

High corrosion stress. Outdoor exposure under moderate corrosive conditions. External visible parts with primarily functional requirements for the surface and which are in direct contact with a normal industrial environment.

Corrosion resistance class CRC 4 to Festo standard FN 940070

Particularly high corrosion stress. Outdoor exposure under extreme corrosive conditions. Parts exposed to aggressive media, for instance in the chemical or food industries. These applications may need to be supported by special tests (→ also FN 940082) using appropriate media.

Standards-based cylinders DSBC, to ISO 15552



Accessories

Swivel flange SNCL

Materials:

Die-cast aluminium

Free of copper and PTFE

RoHS-compliant

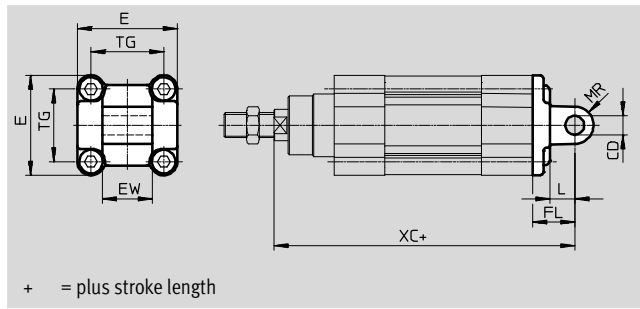
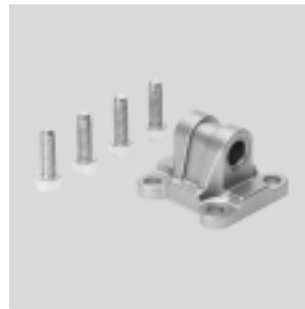

Dimensions and ordering data						
For Ø	CD	E	EW	FL	L	MR
[mm]	Ø H9		h12	±0.2		
32	10	45 ^{+0.2/-0.5}	26	22	13	10
40	12	54 ^{-0.5}	28	25	16	12
50	12	64 ^{-0.6}	32	27	16	12
63	16	75 ^{-0.6}	40	32	21	16
80	16	93 ^{-0.8}	50	36	22	16
100	20	110 ^{+0.3/-0.8}	60	41	27	20
125	25	131 ^{-0.8}	70	50	30	25

For Ø	TG	XC		CRC ¹⁾	Weight	Part No.	Type
		DSBC-...	DSBC-...-C				
[mm]					[g]		
32	32.5	141.1	186.1	2	71	174404	SNCL-32
40	38	158.9	211.9	2	95	174405	SNCL-40
50	46.5	168.8	235.8	2	158	174406	SNCL-50
63	56.5	189.1	265.1	2	225	174407	SNCL-63
80	72	209.6	304.6	2	436	174408	SNCL-80
100	89	228.5	326.7	2	606	174409	SNCL-100
125	110	275	399.3	2	1135	174410	SNCL-125

1) Corrosion resistance class CRC 2 to Festo standard FN 940070

Moderate corrosion stress. Indoor applications in which condensation may occur. External visible parts with primarily decorative requirements for the surface and which are in direct contact with the ambient atmosphere typical for industrial applications.

Standards-based cylinders DSBC, to ISO 15552

Accessories

Trunnion mounting kit DAMT

The mounting kit can be attached at any position along the profile barrel of the cylinder.

Materials:
Galvanised steel
RoHS compliant

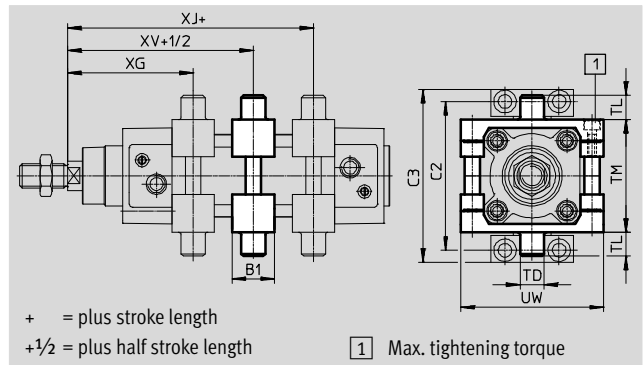

Dimensions and ordering data							
For Ø	B1	C2	C3	TD	TL	TM	UW
[mm]				Ø e9			
32	30	71	86	12	12	50	65
40	32	87	105	16	16	63	75
50	34	99	117	16	16	75	95
63	41	116	136	20	20	90	105
80	44	136	156	20	20	110	130
100	48	164	189	25	25	132	145
125	50	192	217	25	25	160	177

For Ø	XG	XJ	XV	Max. tightening torque	CRC ¹⁾	Weight	Part No.	Type ²⁾
[mm]	Min.	max.		[Nm]		[g]		
32	69±1.4	76±1.4	73±1.4	4+1	1	213	2213233	DAMT-V1-32-A
40	77.7±1.4	84.9±1.4	81.2±1.4	8+1	1	388	2214899	DAMT-V1-40-A
50	85.6±1.4	91.8±1.4	88.6±1.4	8+2	1	608	2214909	DAMT-V1-50-A
63	96.9±1.8	96.1±1.8	96.4±1.8	18+2	1	911	2214971	DAMT-V1-63-A
80	110.4±1.8	108.6±1.8	109.4±1.8	28+2	1	1494	163529	DAMT-V1-80-A
100	121.3±1.8	115.5±1.8	118.3±1.8	28+2	1	2095	163530	DAMT-V1-100-A
125	134.7±1.8	155.3±1.8	145±1.8	40+2	1	3548	1812524	DAMT-V8-125-A

- Corrosion resistance class CRC 1 to Festo standard FN 940070
Low corrosion stress. For dry indoor applications or transport and storage protection. Also applies to parts behind covers, in the non-visible interior area, and parts which are covered in the application (e.g. drive trunnions).
- Suitable for ATEX

Standards-based cylinders DSBC, to ISO 15552

FESTO

Accessories

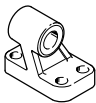
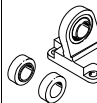
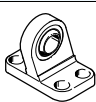
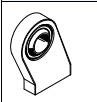
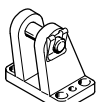
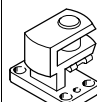
Ordering data – Mounting components				Technical data → Internet: clevis foot			
Description	For Ø	Part No.	Type	Description	For Ø	Part No.	Type
Clevis foot LNG				Clevis foot LSN			
	32	33890	LNG-32		32	5561	LSN-32
	40	33891	LNG-40		40	5562	LSN-40
	50	33892	LNG-50		50	5563	LSN-50
	63	33893	LNG-63		63	5564	LSN-63
	80	33894	LNG-80		80	5565	LSN-80
	100	33895	LNG-100		100	5566	LSN-100
	125	33896	LNG-125		125	6987	LSN-125
Clevis foot LSNG				Clevis foot LSNSG			
	32	31740	LSNG-32		32	31747	LSNSG-32
	40	31741	LSNG-40		40	31748	LSNSG-40
	50	31742	LSNG-50		50	31749	LSNSG-50
	63	31743	LSNG-63		63	31750	LSNSG-63
	80	31744	LSNG-80		80	31751	LSNSG-80
	100	31745	LSNG-100		100	31752	LSNSG-100
	125	31746	LSNG-125		125	31753	LSNSG-125
Clevis foot LBG¹⁾				Right-angle clevis foot LQG¹⁾			
	32	31761	LBG-32		32	31768	LQG-32
	40	31762	LBG-40		40	31769	LQG-40
	50	31763	LBG-50		50	31770	LQG-50
	63	31764	LBG-63		63	31771	LQG-63
	80	31765	LBG-80		80	31772	LQG-80
	100	31766	LBG-100		100	31773	LQG-100
	125	31767	LBG-125		125	31774	LQG-125



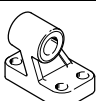

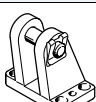
1) Suitable for ATEX

Ordering data – Mounting components, corrosion-resistant			Technical data → Internet: crlng	
Description	For Ø	Part No.	Type	
Clevis foot CRLNG				
	32	161840	CRLNG-32	
	40	161841	CRLNG-40	
	50	161842	CRLNG-50	
	63	161843	CRLNG-63	
	80	161844	CRLNG-80	
	100	161845	CRLNG-100	
	125	176951	CRLNG-125	



Ordering – Mounting attachments, high corrosion protection			Technical data → Internet: clevis foot	
Designation	For Ø	Part No.	Type	
Clevis foot LBG-R3				
	32	2078790	LBG-32-R3	
	40	2078792	LBG-40-R3	
	50	2078794	LBG-50-R3	
	63	2078795	LBG-63-R3	
	80	2078797	LBG-80-R3	
	100	2078799	LBG-100-R3	
	125	2078837	LBG-125-R3	

Standards-based cylinders DSBC, to ISO 15552

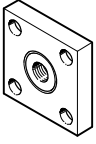
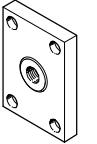
Accessories

Ordering data – Piston rod attachments				Technical data → Internet: piston-rod attachment			
Description	For Ø	Part No.	Type	Description	For Ø	Part No.	Type
Rod eye SGS				Rod clevis SGA¹⁾			
	32	9261	SGS-M10x1,25		32	32954	SGA-M10x1,25
	40	9262	SGS-M12x1,25		40	10767	SGA-M12x1,25
	50	9263	SGS-M16x1,5		50	10768	SGA-M16x1,5
	63						
	80	9264	SGS-M20x1,5		80	10769	SGA-M20x1,5
	100	10774	SGS-M27x2		100	10770	SGA-M27x2
	125						
Rod clevis SG¹⁾				Self-aligning rod coupler FK¹⁾			
	32	6144	SG-M10x1,25		32	6140	FK-M10x1,25
	40	6145	SG-M12x1,25		40	6141	FK-M12x1,25
	50	6146	SG-M16x1,5		50	6142	FK-M16x1,5
	63						
80	6147	SG-M20x1,5	80	6143	FK-M20x1,5		
	100	14987	SG-M27x2-B	100	10485	FK-M27x2	
	125						
Coupling piece KSG¹⁾				Coupling piece KSZ¹⁾			
	32	32963	KSG-M10x1,25		32	36125	KSZ-M10x1,25
	40	32964	KSG-M12x1,25		40	36126	KSZ-M12x1,25
	50	32965	KSG-M16x1,5		50	36127	KSZ-M16x1,5
	63						
	80	32966	KSG-M20x1,5		80	36128	KSZ-M20x1,5
	100	32967	KSG-M27x2		100	-	-
	125						

1) Suitable for ATEX

Ordering data – Piston-rod attachments, corrosion-resistant				Technical data → Internet: piston-rod attachment			
Description	For Ø	Part No.	Type	Description	For Ø	Part No.	Type
Rod eye CRSGS				Rod clevis CRSG¹⁾			
	32	195582	CRSGS-M10x1,25		32	13569	CRSG-M10x1,25
	40	195583	CRSGS-M12x1,25		40	13570	CRSG-M12x1,25
	50	195584	CRSGS-M16x1,5		50	13571	CRSG-M16x1,5
	63						
	80	195585	CRSGS-M20x1,5		80	13572	CRSG-M20x1,5
	100	195586	CRSGS-M27x2		100	185361	CRSG-M27x2
	125						
Self-aligning rod coupler CRFK¹⁾							
	32	2305778	CRFK-M10x1,25				
	40	2305779	CRFK-M12x1,25				
	50	2490673	CRFK-M16x1,5				
	63						
	80	2545677	CRFK-M20x1,5				
	100						

1) Suitable for ATEX

Standards-based cylinders DSBC, to ISO 15552

Accessories

Bellows kit DADB



General technical data							
Type DADB-V6-		32	40	50	63	80	100
Max. stroke range of cylinder ¹⁾	[mm]	10 ... 500	10 ... 500	10 ... 500	10 ... 500	10 ... 500	10 ... 500
Type of mounting		Via threaded pin					
Mounting position		Any					
Resistance to media		Dust, chippings, oil, grease, fuel (→ Internet: Resistance to media)					
Ambient temperature ²⁾	[°C]	-10 ... +80					
Degree of protection		IP54					
Corrosion resistance class CRC ³⁾		3					

1) In combination with bellows kit DADB

2) Note operating range of proximity sensors and cylinder

3) Corrosion resistance class CRC 3 to Festo standard FN 940070

High corrosion stress. Outdoor exposure under moderate corrosive conditions. External visible parts with primarily functional requirements for the surface and which are in direct contact with a normal industrial environment.

Materials

Sectional view

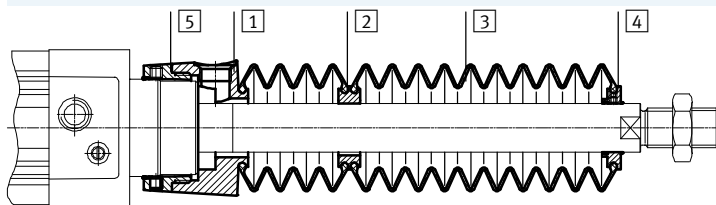

Bellows		
1	Connection	Polyamide
2	Adapter	Polyamide
3	Bellows	NBR
4	End piece	Polyamide
5	Connector	Polyamide
-	O-ring	NBR
Note on materials		Free of copper and PTFE
		RoHS compliant

Weight [g]							
Type DADB-V6-		32	40	50	63	80	100
Stroke [mm]							
10 ... 50		29	42	71	69	99	124
51 ... 125		41	56	91	89	127	152
126 ... 175		52	68	105	103	140	165
176 ... 250		66	85	129	127	193	218
251 ... 300		79	100	147	145	231	255
301 ... 350		92	115	166	164	268	293
351 ... 375		92	115	167	165	259	284
376 ... 425		104	129	185	183	296	321
426 ... 475		117	144	204	202	334	359
476 ... 500		117	144	205	203	324	349

Standards-based cylinders DSBC, to ISO 15552

Accessories

Travel speed v as a function of tubing length l

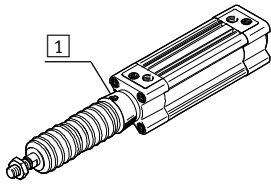

The bellows kit is a leak-free system. To prevent unwanted media from being drawn in, the supply and exhaust air must be ducted via a pressure compensation hole in the

connection part **1**.

The pressure generated in the bellows kit by the positioning motion is primarily defined by the travel speed

and tubing length. The recommended tubing length based on the travel speed of the drive can be read from the graph.

Advancing

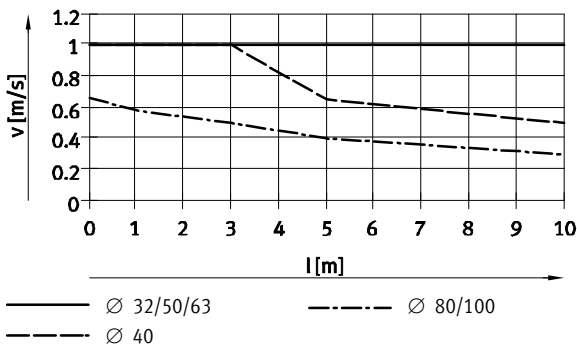

Retracting

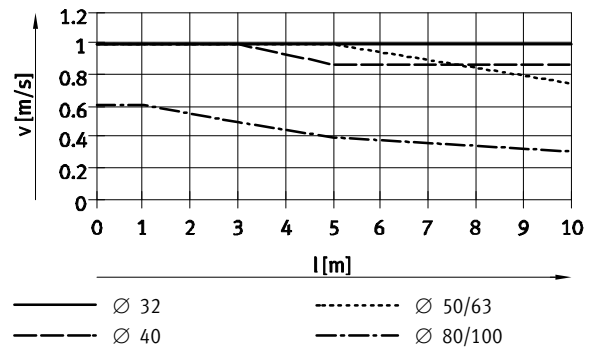

Note
The push-in fittings in the adjacent table must be used for the pressure compensation hole. Silencers can be used as an alternative. This reduces the travel speed slightly.

Tube size and push-in fitting for pressure compensation hole		
Ø [mm]	Tubing O.D. [mm]	Push-in fitting
		Part No. Type
32, 40	8	186109 QS-G $\frac{1}{8}$ -8-1
		578376 NPQH-DK-G18-Q8-P10
		578362 NPQH-D-G18-S8-P10
50, 63, 80, 100	12	186350 QS-G $\frac{1}{4}$ -12
		578344 NPQH-D-G14-Q12-P10
		578366 NPQH-D-G14-S12-P10

Standards-based cylinders DSBC, to ISO 15552

Accessories

FESTO

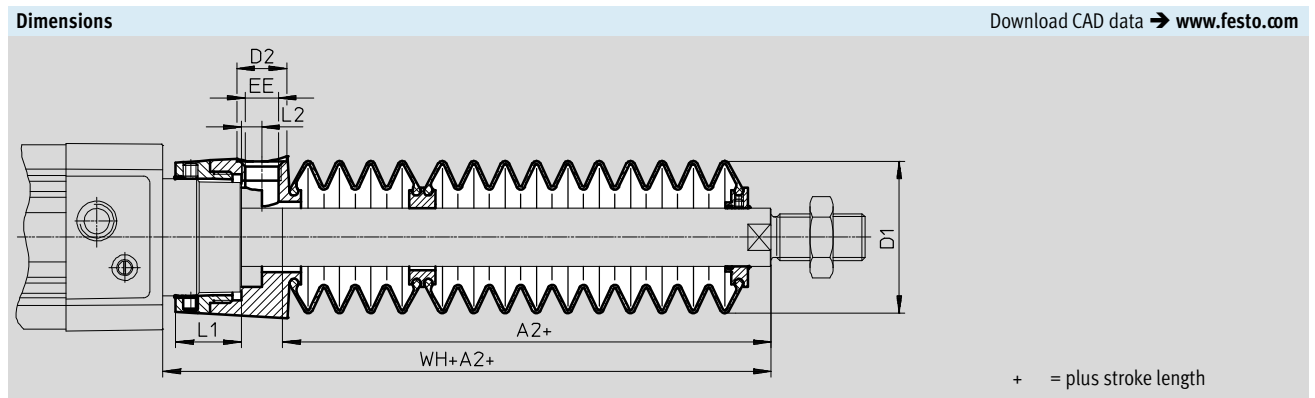

Ø Stroke [mm]	32							40						
	A2 ¹⁾	D1 max.	D2	EE	L1	L2	WH+A2	A2 ¹⁾	D1 max.	D2	EE	L1	L2	WH+A2
10 ... 50	29	38	14	G1/8	12.9	5.4	55	28	46	14	G1/8	16.3	5.4	56.7
51 ... 125	47						73	43						71.7
126 ... 175	61						87	56						84.7
176 ... 250	80						106	72						100.7
251 ... 300	96						122	86						114.7
301 ... 350	112						138	100						128.7
351 ... 375	114						140	101						129.7
376 ... 425	130						156	115						143.7
426 ... 475	145						171	130						158.7
476 ... 500	147						173	131						159.7

Ø Stroke [mm]	50							63						
	A2 ¹⁾	D1 max.	D2	EE	L1	L2	WH+A2	A2 ¹⁾	D1 max.	D2	EE	L1	L2	WH+A2
10 ... 50	28	57	17	G1/4	22.35	7	63.6	28	57	17	G1/4	22.4	7	63.9
51 ... 125	46						81.6	46						81.9
126 ... 175	56						91.6	56						91.9
176 ... 250	73						108.6	73						108.9
251 ... 300	86						121.6	86						121.9
301 ... 350	97						132.6	97						132.9
351 ... 375	105						140.6	105						140.9
376 ... 425	116						151.6	116						151.9
426 ... 475	126						161.6	126						161.9
476 ... 500	134						169.6	134						169.9

Ø Stroke [mm]	80							100						
	A2 ¹⁾	D1 max.	D2	EE	L1	L2	WH+A2	A2 ¹⁾	D1 max.	D2	EE	L1	L2	WH+A2
10 ... 50	25	93	17	G1/4	28	4	70.4	25	93	17	G1/4	28	4	74.3
51 ... 125	37						82.4	37						86.3
126 ... 175	49						94.4	49						98.3
176 ... 250	62						107.4	62						111.3
251 ... 300	74						119.4	74						123.3
301 ... 350	86						131.4	86						135.3
351 ... 375	87						132.4	87						136.3
376 ... 425	98						143.4	98						147.3
426 ... 475	110						155.4	110						159.3
476 ... 500	111						156.4	111						160.3

1) The dimension corresponds to the E value (piston rod extension) of the drive

Standards-based cylinders DSBC, to ISO 15552

Accessories

Ordering data – Bellows kit

An extended piston rod (order code E) is required when using a bellows kit
 → Ordering data – Modular products.

The necessary dimension for order code E as a function of piston diameter and cylinder stroke as well as the corresponding bellows kit is indicated in the table below:

Order example:

Selected standards-based cylinder:

DSBC-32-320-PPV-A- ...

The dimension for the corresponding E value (see table):
 112 mm

Complete type code for standards-based cylinder:

DSBC-32-320-PPV-A- ...-112E

The corresponding bellows kit:

DADB-V6-32-S301-350

Cylinder data			Bellows kit		Cylinder data			Bellows kit	
∅	Stroke	Dimen- sion for E	Part No.	Type	∅	Stroke	Dimen- sion for E	Part No.	Type
[mm]	[mm]	[mm]			[mm]	[mm]	[mm]		
32	10 ... 50	29	553271	DADB-V6-32-S10-50	40	10 ... 50	28	553291	DADB-V6-40-S10-50
	51 ... 125	47	553273	DADB-V6-32-S51-125		51 ... 125	43	553293	DADB-V6-40-S51-125
	126 ... 175	61	553275	DADB-V6-32-S126-175		126 ... 175	56	553295	DADB-V6-40-S126-175
	176 ... 250	80	553277	DADB-V6-32-S176-250		176 ... 250	72	553297	DADB-V6-40-S176-250
	251 ... 300	96	553279	DADB-V6-32-S251-300		251 ... 300	86	553399	DADB-V6-40-S251-300
	301 ... 350	112	553281	DADB-V6-32-S301-350		301 ... 350	100	553301	DADB-V6-40-S301-350
	351 ... 375	114	553283	DADB-V6-32-S351-375		351 ... 375	101	553303	DADB-V6-40-S351-375
	376 ... 425	130	553285	DADB-V6-32-S376-425		376 ... 425	115	553305	DADB-V6-40-S376-425
	426 ... 475	145	553287	DADB-V6-32-S426-475		426 ... 475	130	553307	DADB-V6-40-S426-475
	476 ... 500	147	553289	DADB-V6-32-S476-500		476 ... 500	131	553309	DADB-V6-40-S476-500
50	10 ... 50	28	553311	DADB-V6-50-S10-50	63	10 ... 50	28	553331	DADB-V6-63-S10-50
	51 ... 125	46	553313	DADB-V6-50-S51-125		51 ... 125	46	553333	DADB-V6-63-S51-125
	126 ... 175	56	553315	DADB-V6-50-S126-175		126 ... 175	56	553335	DADB-V6-63-S126-175
	176 ... 250	73	553317	DADB-V6-50-S176-250		176 ... 250	73	553337	DADB-V6-63-S176-250
	251 ... 300	86	553319	DADB-V6-50-S251-300		251 ... 300	86	553339	DADB-V6-63-S251-300
	301 ... 350	97	553321	DADB-V6-50-S301-350		301 ... 350	97	553341	DADB-V6-63-S301-350
	351 ... 375	105	553323	DADB-V6-50-S351-375		351 ... 375	105	553343	DADB-V6-63-S351-375
	376 ... 425	116	553325	DADB-V6-50-S376-425		376 ... 425	116	553345	DADB-V6-63-S376-425
	426 ... 475	126	553327	DADB-V6-50-S426-475		426 ... 475	126	553347	DADB-V6-63-S426-475
	476 ... 500	134	553329	DADB-V6-50-S476-500		476 ... 500	134	553349	DADB-V6-63-S476-500
80	10 ... 50	25	553351	DADB-V6-80-S10-50	100	10 ... 50	25	553371	DADB-V6-100-S10-50
	51 ... 125	37	553353	DADB-V6-80-S51-125		51 ... 125	37	553373	DADB-V6-100-S51-125
	126 ... 175	49	553355	DADB-V6-80-S126-175		126 ... 175	49	553375	DADB-V6-100-S126-175
	176 ... 250	62	553357	DADB-V6-80-S176-250		176 ... 250	62	553377	DADB-V6-100-S176-250
	251 ... 300	74	553359	DADB-V6-80-S251-300		251 ... 300	74	553379	DADB-V6-100-S251-300
	301 ... 350	86	553361	DADB-V6-80-S301-350		301 ... 350	86	553381	DADB-V6-100-S301-350
	351 ... 375	87	553363	DADB-V6-80-S351-375		351 ... 375	87	553383	DADB-V6-100-S351-375
	376 ... 425	98	553365	DADB-V6-80-S376-425		376 ... 425	98	553385	DADB-V6-100-S376-425
	426 ... 475	110	553367	DADB-V6-80-S426-475		426 ... 475	110	553387	DADB-V6-100-S426-475
	476 ... 500	111	553369	DADB-V6-80-S476-500		476 ... 500	111	553389	DADB-V6-100-S476-500

Standards-based cylinders DSBC, to ISO 15552

Accessories



Multi-position kit DPNC

Materials:

Flange: Wrought aluminium alloy
Threaded pins, hex nuts: Galvanised steel

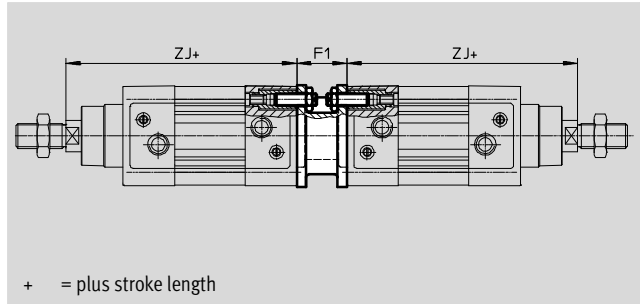
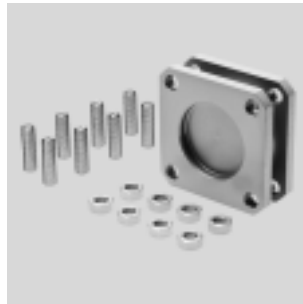

Dimensions and ordering data

For \varnothing [mm]	F1	ZJ		Max. total stroke [mm]	Weight [g]	Part No.	Type ¹⁾
		DSBC-... +1.8	DSBC-...-C				
32	27	119.1	164.1	500	292	174418	DPNC-32
40	27	133.9	186.9	800	410	174419	DPNC-40
50	32	141.8	208.8	800	335	174420	DPNC-50
63	28	157.1	233.1	700	390	174421	DPNC-63
80	38	173.6	268.6	1000	847	174422	DPNC-80
100	38	187.5	285.7	900	1200	174423	DPNC-100
125	48	225	349.3	1000	2102	174424	DPNC-125

1) Suitable for ATEX

 Note
The maximum overall stroke length must not be exceeded when combining cylinders and multi-position kits.

Connecting two cylinders with identical piston \varnothing as a 3 or 4-position cylinder

A 3 or 4-position cylinder consists of two separate cylinders whose piston rods advance in opposing directions.

This means that depending on actuation and stroke division, this type of cylinder can assume up to four

positions. In each case the cylinder is driven precisely against a stop. Note that when one end of the piston rod is

fixed, the cylinder barrel executes the movement. The line connections to the cylinder must be flexible.

To achieve 3 positions

Two cylinders with identical stroke lengths must be connected together.

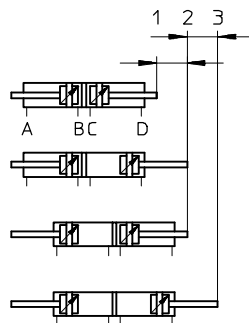

To achieve 4 positions

Two cylinders with different stroke lengths must be connected together.

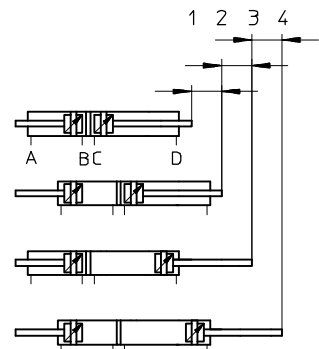

Standards-based cylinders DSBC, to ISO 15552

Accessories

Mounting kit DAVM

For lateral valve assembly, directly on the drive

Materials:
Mounting bracket, screws: Galvanised steel
Slot nut: High-alloy stainless steel

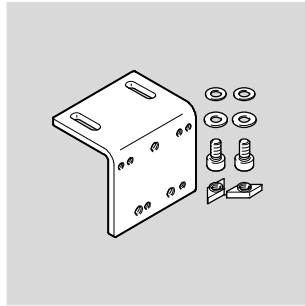

Example:

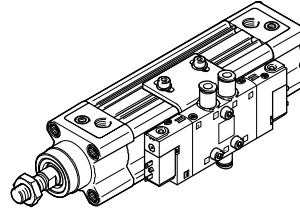

The hole pattern on the angle bracket enables solenoid valves to be attached on the right according to the assignment. The following table shows a few solenoid valves that are available.

Allocation table, mounting kit for solenoid valves		
Mounting kit	Solenoid valve	
DAVM-MW-V1-32-V	CPE14	VUVG-L14
DAVM-MW-V1-50-V	CPE18, CPE24	VUVG-L18



Recommended solenoid valves CPE						Technical data → Internet: cpe
	For Ø [mm]	Mounting screw	Pneumatic port	Function	Part No.	Type
	Single solenoid					
	32, 40	M4x20	G3/8	5/2-way valve	196941	CPE14-M1BH-5L-1/8
	50, 63	M4x25	G1/4		163142	CPE18-M1H-5L-1/4
	80, 100, 125	M5x30	G3/8		163166	CPE24-M1H-5L-3/8
	Double solenoid					
	32, 40	M4x20	G3/8	5/2-way valve	196939	CPE14-M1BH-5J-1/8
50, 63	M4x25	G1/4	163143		CPE18-M1H-5J-1/4	
80, 100, 125	M5x30	G3/8	163167		CPE24-M1H-5J-3/8	

Accessories for solenoid valves CPE					
	For valve	Cable length [m]	Part No.	Type	
Connecting cable NEBV/KMEB					
	CPE14	2.5	8047679	NEBV-Z4WA2L-R-E-2.5-N-LE2-S1	
		5	8047680	NEBV-Z4WA2L-R-E-5-N-LE2-S1	
	CPE18	2.5	151688	KMEB-1-24-2,5-LED	
	CPE24	5	151689	KMEB-1-24-5-LED	
		10	193457	KMEB-1-24-10-LED	

Standards-based cylinders DSBC, to ISO 15552

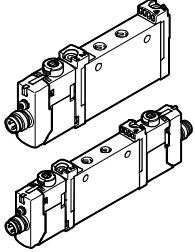
Accessories

Recommended solenoid valves VUVG						Technical data → Internet: vuvg	
	For Ø [mm]	Mounting screw	Pneumatic port	Function	Part No.	Type	
	Single solenoid						
	32, 40	M3x20	G $\frac{1}{8}$	5/2-way valve	8031508	VUVG-L14-M52-MT-G18-1R8L	
	50, 63	M4x25	G $\frac{1}{4}$		8031532	VUVG-L18-M52-MT-G14-1R8L	
	Double solenoid						
	32, 40	M3x20	G $\frac{1}{8}$	5/2-way valve	574230	VUVG-L14-B52-T-G18-1R8L	
	50, 63	M4x25	G $\frac{1}{4}$		8031533	VUVG-L18-B52-T-G14-1R8L	

Accessories for solenoid valves VUVG						Technical data → Internet: nebu	
	For valve	Electrical connection	Cable length	Part No.	Type		
Connecting cable NEBU							
	VUVG-L14	Straight socket, M8x1, 3-pin	2.5 m	541333	NEBU-M8G3-K-2.5-LE3		
	VUVG-L18		5 m	541334	NEBU-M8G3-K-5-LE3		
		Angled socket, M8x1, 3-pin	2.5 m	541338	NEBU-M8W3-K-2.5-LE3		
			5 m	541341	NEBU-M8W3-K-5-LE3		

-  - Note
 Dimensions and ordering data → 57

Standards-based cylinders DSBC, to ISO 15552

Accessories

Dimensions and ordering data

Download CAD data → www.festo.com

DAVM-MW-V1-32-V

DAVM-MW-V1-50-V

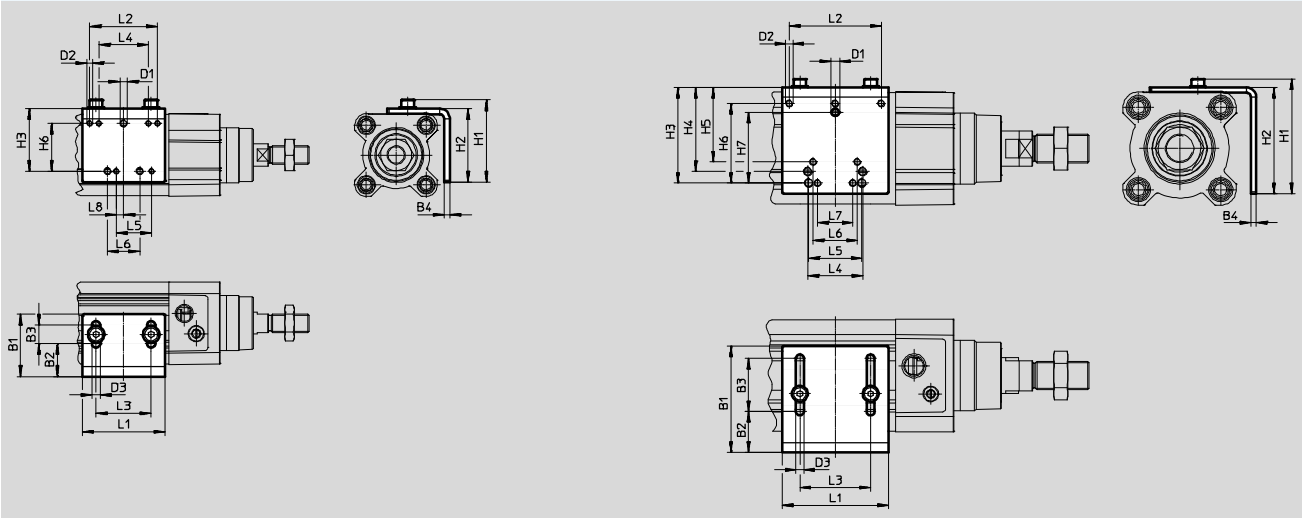

- - Note

Mounting is only possible on the side on which the pneumatic connections are located.

Two slot nuts are included in the scope of delivery of the mounting kit. Other slot nuts → 60

For Ø [mm]	B1	B2	B3	B4	D1	D2	D3 Ø	H1	H2	H3	H4	H5	H6	H7
32	34	18	10	3	M4	M3	4.5	44.8	40	34	-	-	26	-
40														
50	60	23	30	3	M5	M4	4.5	64.8	60	54	47.5	42	45	40
63														
80														
100														
125														

For Ø [mm]	L1	L2	L3	L4	L5	L6	L7	L8	CRC ¹⁾	Weight [g]	Part No.	Type
32	45	37	30	27	19.2	17.5	-	4	1	76	2568514	DAVM-MW-V1-32-V
40												
50	60	52	40	31	30	25	20	-	1	160	2612128	DAVM-MW-V1-50-V
63												
80												
100												
125												

1) Corrosion resistance class CRC 1 to Festo standard FN 940070
 Low corrosion stress. For dry indoor applications or transport and storage protection. Also applies to parts behind covers, in the non-visible interior area, and parts which are covered in the application (e.g. drive trunnions).

Standards-based cylinders DSBC, to ISO 15552

Accessories

FESTO

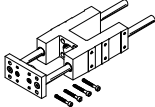
Ordering data – Guide units for fixed strokes (recirculating ball bearing guide only)				Technical data → Internet: feng		
	Stroke [mm]	Part No.	Type ¹⁾	Stroke [mm]	Part No.	Type ¹⁾
	For Ø 32 mm			For Ø 40 mm		
	10 ... 50	34493	FENG-32-50-KF	10 ... 50	34499	FENG-40-50-KF
	10 ... 100	34494	FENG-32-100-KF	10 ... 100	34500	FENG-40-100-KF
	10 ... 160	34495	FENG-32-160-KF	10 ... 160	34501	FENG-40-160-KF
	10 ... 200	34496	FENG-32-200-KF	10 ... 200	34502	FENG-40-200-KF
	10 ... 250	150289	FENG-32-250-KF	10 ... 250	34503	FENG-40-250-KF
	10 ... 320	34497	FENG-32-320-KF	10 ... 320	34504	FENG-40-320-KF
	10 ... 400	150290	FENG-32-400-KF	10 ... 400	150291	FENG-40-400-KF
	10 ... 500	34498	FENG-32-500-KF	10 ... 500	34505	FENG-40-500-KF
	For Ø 50 mm			For Ø 63 mm		
	10 ... 50	34506	FENG-50-50-KF	10 ... 50	34513	FENG-63-50-KF
	10 ... 100	34507	FENG-50-100-KF	10 ... 100	34514	FENG-63-100-KF
	10 ... 160	34508	FENG-50-160-KF	10 ... 160	34515	FENG-63-160-KF
	10 ... 200	34509	FENG-50-200-KF	10 ... 200	34516	FENG-63-200-KF
	10 ... 250	34510	FENG-50-250-KF	10 ... 250	34517	FENG-63-250-KF
	10 ... 320	34511	FENG-50-320-KF	10 ... 320	34518	FENG-63-320-KF
	10 ... 400	150292	FENG-50-400-KF	10 ... 400	34519	FENG-63-400-KF
	10 ... 500	34512	FENG-50-500-KF	10 ... 500	34520	FENG-63-500-KF
	For Ø 80 mm			For Ø 100 mm		
	10 ... 50	34521	FENG-80-50-KF	10 ... 50	34529	FENG-100-50-KF
	10 ... 100	34522	FENG-80-100-KF	10 ... 100	34530	FENG-100-100-KF
	10 ... 160	34523	FENG-80-160-KF	10 ... 160	34531	FENG-100-160-KF
	10 ... 200	34524	FENG-80-200-KF	10 ... 200	34532	FENG-100-200-KF
	10 ... 250	34525	FENG-80-250-KF	10 ... 250	34533	FENG-100-250-KF
	10 ... 320	34526	FENG-80-320-KF	10 ... 320	34534	FENG-100-320-KF
	10 ... 400	34527	FENG-80-400-KF	10 ... 400	34535	FENG-100-400-KF
	10 ... 500	34528	FENG-80-500-KF	10 ... 500	34536	FENG-100-500-KF

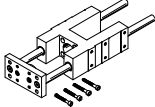
Ordering data – Guide units for variable strokes				Technical data → Internet: feng	
	For Ø [mm]	Stroke [mm]	With recirculating ball bearing guide Part No. Type ¹⁾	With plain-bearing guide Part No. Type ¹⁾	
	32	10 ... 500	34487 FENG-32-...-KF	34481 FENG-32-...-GF	
	40	10 ... 500	34488 FENG-40-...-KF	34482 FENG-40-...-GF	
	50	10 ... 500	34489 FENG-50-...-KF	34483 FENG-50-...-GF	
	63	10 ... 500	34490 FENG-63-...-KF	34484 FENG-63-...-GF	
	80	10 ... 500	34491 FENG-80-...-KF	34485 FENG-80-...-GF	
	100	10 ... 500	34492 FENG-100-...-KF	34486 FENG-100-...-GF	

1) Suitable for ATEX

Standards-based cylinders DSBC, to ISO 15552

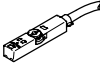
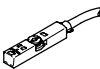

Accessories

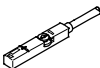
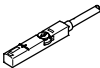
Ordering data – Proximity sensor for T-slot, magneto-resistive						Technical data → Internet: smt	
	Type of mounting	Switching output	Electrical connection	Cable length [m]	Part No.	Type	
N/O contact							
	Inserted in the slot from above, flush with the cylinder profile, short design	PNP	Cable, 3-wire	2.5	574335	SMT-8M-A-PS-24V-E-2,5-OE	
			Plug connector M8x1, 3-pin	0.3	574334	SMT-8M-A-PS-24V-E-0,3-M8D	
			Plug connector M12x1, 3-pin	0.3	574337	SMT-8M-A-PS-24V-E-0,3-M12	
		NPN	Cable, 3-wire	2.5	574338	SMT-8M-A-NS-24V-E-2,5-OE	
			Plug connector M8x1, 3-pin	0.3	574339	SMT-8M-A-NS-24V-E-0,3-M8D	
N/C contact							
	Inserted in the slot from above, flush with the cylinder profile, short design	PNP	Cable, 3-wire	7.5	574340	SMT-8M-A-PO-24V-E-7,5-OE	

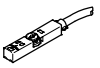
Ordering data – Proximity sensors for T-slot, magnetic reed						Technical data → Internet: sme	
	Type of mounting	Switching output	Electrical connection	Cable length [m]	Part No.	Type	
N/O contact							
	Inserted in the slot from above, flush with the cylinder profile	Contacting	Cable, 3-wire	2.5	543862	SME-8M-DS-24V-K-2,5-OE	
				5.0	543863	SME-8M-DS-24V-K-5,0-OE	
			Cable, 2-wire	2.5	543872	SME-8M-ZS-24V-K-2,5-OE	
				Plug connector M8x1, 3-pin	0.3	543861	SME-8M-DS-24V-K-0,3-M8D
N/C contact							
	Insertable in the slot from above, flush with the cylinder profile	Contacting	Cable, 3-wire	7.5	546799	SME-8M-DO-24V-K-7,5-OE	

Ordering data – Proximity sensor for T-slot, magneto-resistive, for ATEX zone							Technical data → Internet: smt	
	Type of mounting	ATEX category		Switching output	Electrical connection	Cable length [m]	Part No.	Type
		Gas	Dust					
N/O contact								
	Insertable in the slot from above, flush with the cylinder profile, short design	II 3G	II 3D	PNP	Plug connector M8x1, 3-wire	0.3	574342	SMT-8M-A-PS-24V-E-0,3-M8D-EX2

Ordering data – Safety clip for ATEX zone			
	Description	For size	Part No. Type
	<ul style="list-style-type: none"> Protects "equipment that is not intrinsically safe" against simple disconnection, here the plug connector of the proximity sensor SMT and connecting cable NEBU ATEX category: gas: II 3G / dust: II 3D 	Plug connector M8x1	548067 NEAU-M8-GD

Ordering data – Connecting cables					Technical data → Internet: nebu	
	Electrical connection, left	Electrical connection, right	Cable length [m]	Part No.	Type	
	Straight socket, M8x1, 3-pin	Cable, open end, 3-wire	2.5	541333	NEBU-M8G3-K-2.5-LE3	
			5	541334	NEBU-M8G3-K-5-LE3	
	Straight socket, M12x1, 5-pin	Cable, open end, 3-wire	2.5	541363	NEBU-M12G5-K-2.5-LE3	
			5	541364	NEBU-M12G5-K-5-LE3	
	Angled socket, M8x1, 3-pin	Cable, open end, 3-wire	2.5	541338	NEBU-M8W3-K-2.5-LE3	
			5	541341	NEBU-M8W3-K-5-LE3	
	Angled socket, M12x1, 5-pin	Cable, open end, 3-wire	2.5	541367	NEBU-M12W5-K-2.5-LE3	
			5	541370	NEBU-M12W5-K-5-LE3	

Standards-based cylinders DSBC, to ISO 15552



Accessories

FESTO

Position sensors

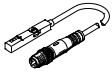

The position sensor continuously senses the position of the piston.

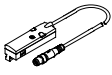
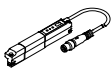
It has an analogue output with an output signal in proportion to the piston position.

Ordering data – Position sensors for T-slot							Technical data → Internet: position transmitter		
	For Ø	Position measuring range	Analogue output		Type of mounting	Electrical connection	Cable length [m]	Part No.	Type
			[V]	[mA]					
	32 ... 125	0 ... 40	0 ... 10	–	Inserted in the slot from above	Plug connector M8x1, 4-pin, in-line	0.3	553744	SMAT-8M-U-E-0,3-M8D
	32 ... 125	0 ... 50	0 ... 10	4 ... 20	Inserted into the slot lengthwise ¹⁾	Plug M8x1, 4-pin, right angle	–	540191	SMAT-8E-S50-IU-M8
						Plug connector M8x1, 4-pin, in-line	0.3	570134	SMAT-8E-S50-IU-E-0,3-M8D
	32 ... 125	0 ... 50	–	4 ... 20	Inserted in the slot from above	Plug connector M8x1, 4-pin, in-line	0.3	1531265	SDAT-MHS-M50-1L-SA-E-0.3-M8
		0 ... 80						1531266	SDAT-MHS-M80-1L-SA-E-0.3-M8
		0 ... 100						1531267	SDAT-MHS-M100-1L-SA-E-0.3-M8
		0 ... 125						1531268	SDAT-MHS-M125-1L-SA-E-0.3-M8
		0 ... 160						1531269	SDAT-MHS-M160-1L-SA-E-0.3-M8

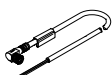
1) Can only be used in combination with DSBC-...-D3.

Ordering data – Connecting cables				Technical data → Internet: nebu	
	Electrical connection, left	Electrical connection, right	Cable length [m]	Part No.	Type
	Straight socket, M8x1, 4-pin	Cable, open end, 4-wire	2.5	541342	NEBU-M8G4-K-2.5-LE4
			5	541343	NEBU-M8G4-K-5-LE4
	Angled socket, M8x1, 4-pin	Cable, open end, 4-wire	2.5	541344	NEBU-M8W4-K-2.5-LE4
			5	541345	NEBU-M8W4-K-5-LE4

Ordering data				
	Description	Part No.	Type	PU ¹⁾
Slot cover for T-slot				
	Insertable, length 0.5 m	151680	ABP-5-S	2
Slot nut for T-slot				
	Insertable in the slot from above, thread M4	8028500	ABAN-8-1M4-5-P2	2
		8028501	ABAN-8-1M4-5-P100	100

1) Packaging unit