

Round cylinders DSNU/DSNUP/DSN/ESNU/ESN



# - 7 - Type discontinued DSNUP/DSN/ESN Available up until 2017



## Round cylinders DSNU/DSNUP/DSN/ESNU/ESN

Key features

At a glance	
<b>DSNU-8 ... 63</b> <ul style="list-style-type: none"> <li>Stainless steel piston rod</li> <li>Good running performance and long service</li> <li>Piston rod with external and internal thread</li> </ul>	<b>DSNU-8 ... 25</b> <ul style="list-style-type: none"> <li>An extensive range of accessories makes it possible to install the cylinder virtually anywhere</li> </ul>



ISO 6432

- Corresponds to standard design in accordance with ISO 6432. Variants are based on these standards

### Wide choice of variants

DSNU/ESNU-...	DSNUP-...	DSNU/ESNU-...-MA	DSNU-...-MQ
<ul style="list-style-type: none"> <li>Piston Ø 8 ... 63</li> <li>Cylinder barrel made of stainless steel</li> <li>Bearing and end caps made of wrought aluminium alloy</li> </ul> 	<ul style="list-style-type: none"> <li>Piston Ø 16 ... 25</li> <li>Cylinder barrel made of wrought aluminium alloy</li> <li>Bearing and end caps made of polyamide</li> <li>Cost optimised</li> </ul> 	<ul style="list-style-type: none"> <li>Piston Ø 8 ... 63</li> <li>Cylinder barrel made of stainless steel</li> <li>Bearing cap with flange thread</li> <li>Short end cap with axial supply port</li> </ul> 	<ul style="list-style-type: none"> <li>Piston Ø 8 ... 63</li> <li>Cylinder barrel made of stainless steel</li> <li>Bearing cap with flange thread</li> <li>Short end cap with lateral supply port</li> </ul> 
DSNU-...-MH	DSNU-...-KP	DSNU-...-Q	DSN/ESN-...
<ul style="list-style-type: none"> <li>Piston Ø 8 ... 63</li> <li>Cylinder barrel made of stainless steel</li> <li>Direct mounting on bearing cap</li> <li>Short end cap with lateral supply port</li> </ul> 	<ul style="list-style-type: none"> <li>Piston Ø 8 ... 63</li> <li>Cylinder barrel made of stainless steel</li> <li>With clamping unit</li> </ul> 	<ul style="list-style-type: none"> <li>Piston Ø 12 ... 63</li> <li>Cylinder barrel made of stainless steel</li> <li>With square piston rod</li> </ul> 	<ul style="list-style-type: none"> <li>Piston Ø 8 ... 25</li> <li>Cylinder barrel made of stainless steel</li> <li>Without position sensing</li> </ul> 











### Cushioning types

	Cushioning P	Cushioning PPS	Cushioning PPV
<b>Mode of operation</b>	<ul style="list-style-type: none"> <li>The drive is fitted with flexible polymer end position cushioning</li> </ul>	<ul style="list-style-type: none"> <li>The drive is fitted with self-adjusting end position cushioning</li> </ul>	<ul style="list-style-type: none"> <li>The drive is fitted with adjustable end position cushioning</li> </ul>
<b>Application</b>	<ul style="list-style-type: none"> <li>Small loads</li> <li>Low speeds</li> <li>Low impact energy</li> </ul>	<ul style="list-style-type: none"> <li>Small to medium loads</li> <li>Low to medium speeds</li> <li>Medium impact energy</li> </ul>	<ul style="list-style-type: none"> <li>Medium to large loads</li> <li>High speeds</li> <li>High impact energy</li> </ul>
<b>Advantages</b>	<ul style="list-style-type: none"> <li>No adjustment required</li> <li>Time-saving</li> </ul>	<ul style="list-style-type: none"> <li>No adjustment required</li> <li>Time-saving</li> <li>Powerful</li> </ul>	<ul style="list-style-type: none"> <li>Very powerful</li> </ul>

## Round cylinders DSNU/DSNUP/DSN/ESNU/ESN

FESTO

Key features

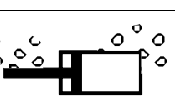
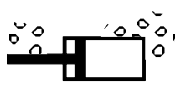
Additional variants		
Symbol	Key features	Description
	S2 Through piston rod	For working at both ends with the same force in the advance and return stroke, for attaching external stops
	S6 Heat resistant seals	Temperature resistance up to max. 120 °C
	S10 Constant (slow speed) operation at low piston speeds	Suitable for slow stroke movements at a constant, stick-slip-free speed over the full stroke of the cylinder. Seal contains silicone grease (not free of paint-wetting impairment substances)
	S11 Low friction	The special seals considerably reduce system wear. This corresponds to a considerably lower response pressure. Seal contains silicone grease (not free of paint-wetting impairment substances)
	K2 Extended male piston rod thread	–
	K3 Female piston rod thread	–
	K5 Special thread on piston rod	Metric standard thread to ISO
	K6 Shortened male piston rod thread	–
	K8 Extended piston rod	–
	R3 High corrosion protection	All external cylinder surfaces comply with corrosion resistance class 3 to Festo standard 940070. The piston rod is made from corrosion and acid resistant steel
	R8 Dust protection (wiper seal) (32 ... 63 mm)	The cylinder is equipped with a hard-chrome plated piston rod and a rigid wiper seal, which protects against dry, dusty media
	A6 Metal wiper seal (32 ... 63 mm)	The cylinder is fitted with a hard-chrome plated piston rod and metal wiper seal which scrapes off hard particles (e.g. welding spatter) that stick to the piston rod. For use in welding systems, for example

### Longer service life with bellows kit DADB



The bellows kit is a leak-free system. To prevent unwanted media from being drawn in, the supply and exhaust air of the kit must be ducted via a pressure compensation hole in the connection section 1.

The kit protects the piston rod, seal and bearing against a wide variety of media, for example:

- dust
- chippings
- oil
- grease
- fuel

**- 7 - Type discontinued DSNUP**  
**Available up until 2017**

**Round cylinders DSNU/DSNUP**

Product range overview

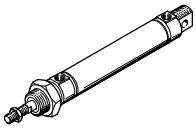
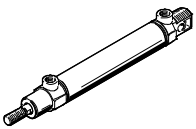
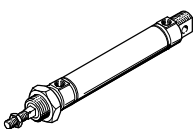
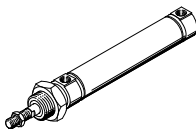
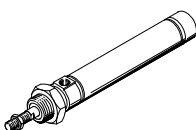
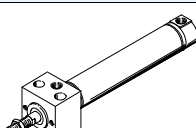

Version	Version	Piston Ø	Stroke	Variable stroke <sup>1)</sup>	Piston rod						
					Through	Extended	Male thread			Female thread	
							Extended	Shortened	Special thread		
		[mm]	[mm]	[mm]	S2	K8	K2	K6	K5	K3	
Double-acting	<b>DSNU-... – Cylinder barrel made of stainless steel</b>										
		8, 10	10, 15, 20, 25,	1 ... 100							
		12, 16	30, 35, 40, 50,	1 ... 200							
		20	60, 70, 80, 100,	1 ... 320							
		25	125, 150, 160,	1 ... 500	■	■	■	■	■	■	■
		32, 40, 50, 63	200, 250, 300, 320, 400, 500						above Ø 25	above Ø 20	
			25, 40, 50, 80, 100, 125, 160, 200, 250, 320	1 ... 500							
	<b>DSNUP-... – Cylinder barrel made of aluminium</b>										
		16	25, 50, 100	2)							
		20			-	-	-	-	-	-	-
25											
<b>DSNU-Q... – Protected against rotation</b>											
	12, 16	-	5 ... 160								
	20	-	5 ... 200								
	25	-	5 ... 250	■	■	■	■	■	■	■	
	32	-	5 ... 300								
	40, 50	-	5 ... 400						above Ø 25	above Ø 20	
	63	-	5 ... 500								
<b>DSNU-MQ... – Lateral air connection</b>											
	8, 10	-	1 ... 100								
	12, 16	-	1 ... 200								
	20	-	1 ... 320	-	■	■	■	■	■	■	
	25	-	1 ... 500								
	32, 40, 50, 63	-	1 ... 500								
<b>DSNU-MA... – Axial air connection</b>											
	8, 10	-	1 ... 100								
	12, 16	-	1 ... 200								
	20	-	1 ... 320	-	■	■	■	■	■	■	
	25	-	1 ... 500								
	32, 40, 50, 63	-	1 ... 500								
<b>DSNU-MH... – Direct mounting</b>											
	8, 10	-	1 ... 100								
	12, 16	-	1 ... 200								
	20	-	1 ... 320	■	■	■	■	■	■	■	
	25	-	1 ... 500								
	32, 40, 50, 63	-	1 ... 500								

1) Cylinders with position sensing require a minimum stroke of 10 mm to ensure reliable sensing

2) Variable stroke on request

## Round cylinders DSNU/DSNUP

Product range overview

Piston rod	Cushioning			Position sensing	Clamping unit	Heat-resistant seal	Slow speed (constant motion operation)	Low friction	Corrosion protection	Dust protection (wiper seal)	Metal wiper seal	→ Page/ Internet
	Fixed	Adjustable	Self-adjusting									
	P	PPV <sup>3)</sup>	PPS									
<b>DSNU-... – Cylinder barrel made of stainless steel</b>												
8 ... 63	■	■ above Ø 16	■ above Ø 16	■	■	■	■ above Ø 12	■ above Ø 12	■ above Ø 12	■ above Ø 32	■ above Ø 32	12
<b>DSNUP-... – Cylinder barrel made of aluminium</b>												
16 ... 25	■	-	-	■	-	-	-	-	-	-	-	46
<b>DSNU-Q... – Protected against rotation</b>												
12 ... 63	■ Ø 12 and above Ø 32	■ above Ø 16	-	■	■	■ above Ø 32	-	-	■ above Ø 16	-	-	50
<b>DSNU-MQ... – Lateral air connection</b>												
8 ... 63	■	■ above Ø 16	■ above Ø 16	■	■	■	-	-	■	■ above Ø 32	■ above Ø 32	12
<b>DSNU-MA... – Axial air connection</b>												
8 ... 63	■ above Ø 32	-	-	■	■	■	-	-	■	-	■	12
<b>DSNU-MH... – Direct mounting</b>												
8 ... 63	■	■ above Ø 32	-	■	-	■	-	-	■	-	-	12

3) In the modular product system from Ø 12 mm

- 7 - Type discontinued DSN/ESN  
Available up until 2017

## Round cylinders DSN/ESNU/ESN

Product range overview

FESTO

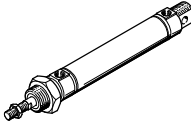
Function	Version	Piston Ø [mm]	Stroke [mm]	Variable stroke <sup>1)</sup> [mm]	Piston rod						
					Through S2	Extended K8	Male thread			Female thread K3	
							Extended K2	Shortened K6	Special thread K5		
Double-acting	<b>DSN-... – without position sensing</b>										
		8, 10	10, 25, 40, 50,	1 ... 100	-	-	-	-	-	-	-
		12, 16	80, 100, 125,	1 ... 200							
		20	160, 200, 250,	1 ... 320							
25		300, 320, 400,	1 ... 500								

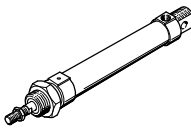
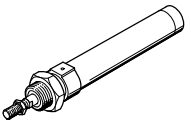
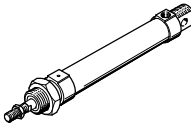
Function	Version	Piston Ø [mm]	Stroke [mm]	Variable stroke <sup>1)</sup> [mm]	Cushioning		Position sensing		
					Fixed P	Fixed A			
Single-acting	<b>ESNU-... – with position sensing</b>								
		8 ... 63	10, 25, 50	1 ... 50		■	■		
		<b>ESNU-MA-... – Axial air connection</b>							
			8 ... 63	-	1 ... 50		■	■	
<b>ESN-... – without position sensing</b>									
	8 ... 25	10, 25, 50	1 ... 50		■	-			

1) Cylinders with position sensing require a minimum stroke of 10 mm to ensure reliable sensing

- 2 - Type discontinued DSN/ESN  
Available up until 2017

## Round cylinders DSN/ESNU/ESN

FESTO

Product range overview

Piston $\varnothing$	Cushioning			Position sensing	Clamping unit	Heat-resistant seal	Slow speed (constant motion operation)	Low friction	Corrosion protection	Dust protection (wiper seal)	→ Page/ Internet
	Fixed	Adjustable	Self-adjusting								
	P	PPV <sup>2)</sup>	PPS								
<b>DSN-... – without position sensing</b>											
8 ... 25	■	■ above $\varnothing$ 16	-	-	-	-	-	-	-	-	70

Piston $\varnothing$	Piston rod					→ Page/ Internet
	Extended	Male thread			Female thread	
		K8	Extended K2	Shortened K6		
<b>ESNU-... – with position sensing</b>						
8 ... 63	■	■	■	■	■	58
<b>ESNU-MA-... – Axial air connection</b>						
8 ... 63	■	■	■	■	■	58
<b>ESN-... – without position sensing</b>						
8 ... 25	-	-	-	-	-	76

2) In the modular product system from  $\varnothing$  12 mm

- 7 - Type discontinued DSNUP/DSN/ESN  
Available up until 2017

## Round cylinders DSNU/DSNUP/DSN/ESNU/ESN

Peripherals overview

FESTO

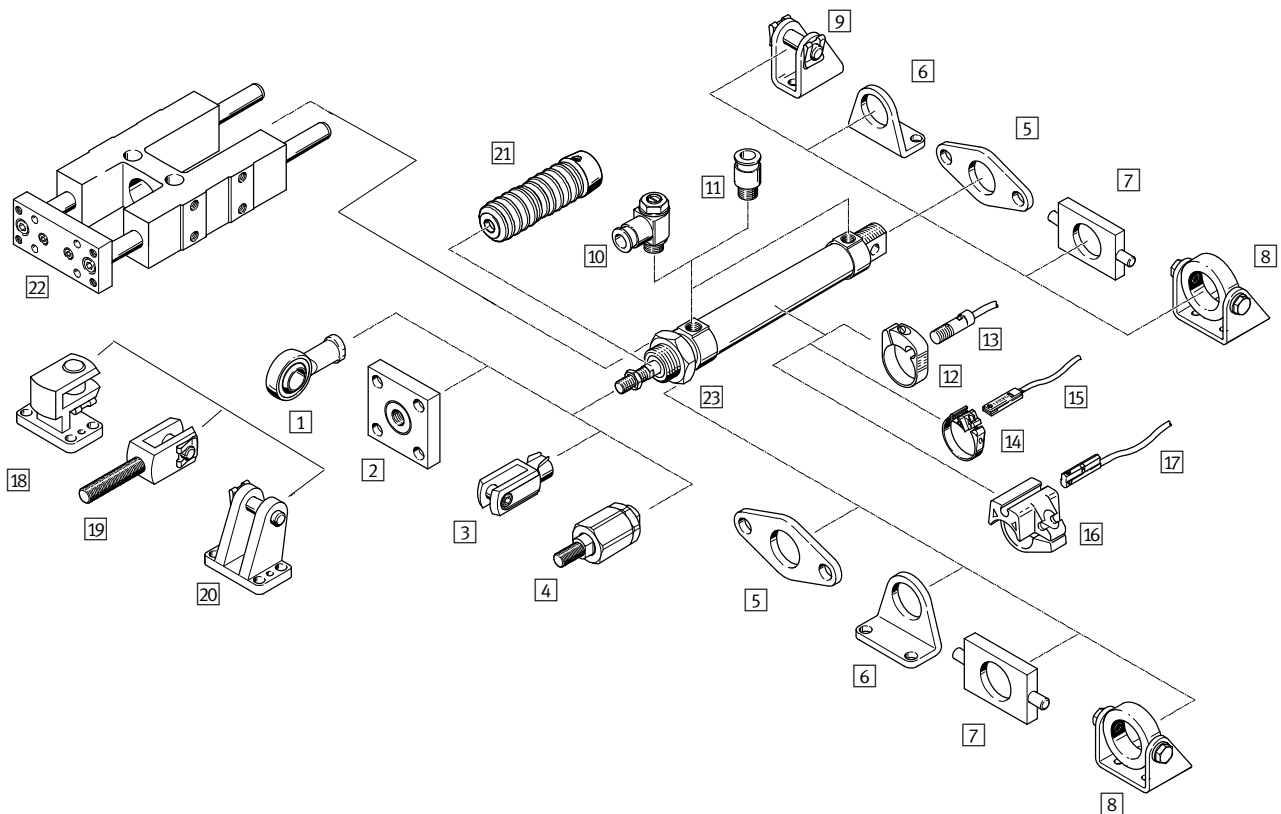

### Variants

DSNU-MQ

DSNU-MA

DSNU-MH

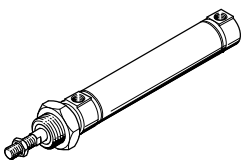

DSNU-Q

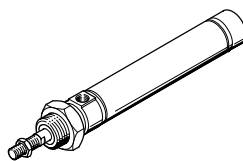

DSNU-KP

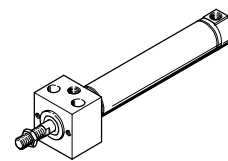

DSNUP

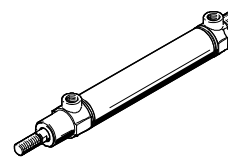
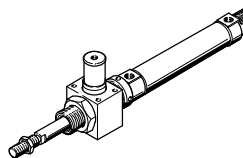
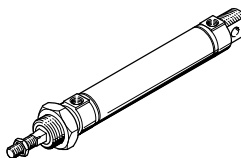

### Mounting options

Mounting front and rear

Mounting with hex nut

Swivel mounting

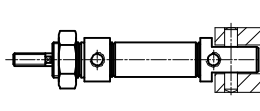
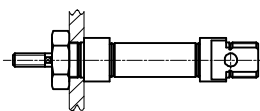
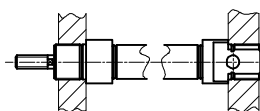

### Installation variants with mounting attachments

Foot mounting (for short strokes)

Foot mounting

Flange mounting

Swivel mounting

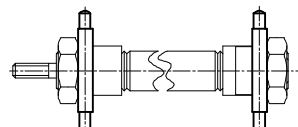
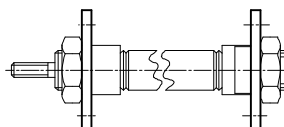
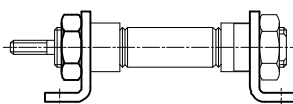
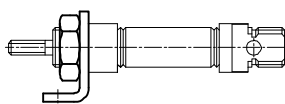



## Round cylinders DSNU/DSNUP/DSN/ESNU/ESN

FESTO

Peripherals overview

Mounting attachments and accessories										
	Piston Ø	DSNU/ ESNU	DSNUP	DSNU/ESNU				DSNU-Q	DSN/ESN	→ Page/ Internet
				MA	MQ	MH	KP			
1	Rod eye SGS/CRSGS	8 ... 63	■	■	■	■	■	■	■	86, 87
2	Coupling piece KSG/KSZ	12 ... 63	■	■	■	■	■	■	■	86
3	Rod clevis SG/CRSG	8 ... 63	■	■	■	■	■	■	■	86, 87
4	Self-aligning rod coupler FK/CRFK	8 ... 63	■	■	■	■	■	■	■	86, 87
5	Flange mounting FBN/CRFBN/CRFV	8 ... 63	■	■	■	■	-	■	■	82, 83
6	Foot mounting HBN/CRHBN/CRH	8 ... 63	■	■	■	■	-	■	■	80, 81
7	Swivel mounting <sup>1)</sup> WBN	8 ... 63	■	■	■	■	-	■	■	84
8	Swivel mounting <sup>1)</sup> SBN	20 ... 63	■	-	■	■	-	■	■	84
9	Clevis foot LBN/CRLBN	8 ... 63	■	■	-	-	-	■	■	85
10	One-way flow control valve <sup>2)</sup> GRLA/GRLZ/CRGRLA	8 ... 63	■	■	■	■	■	■	■	97
11	Push-in fitting <sup>2)</sup> QS	8 ... 63	■	■	■	■	■	■	■	95
12	Mounting kit SMBR/CRSMBR	8 ... 63	■	-	■	■	■	■	-	94
13	Proximity sensor SMEO/SMT0/CRSMEO-4	8 ... 63	■	-	■	■	■	■	-	94
14	Mounting kit SMBR-8	12 ... 63	■	■	■	■	■	■	-	95
15	Proximity sensor SME/SMT-8	8 ... 63	■	■	■	■	■	■	-	95
16	Mounting kit SMBR-10	12 ... 63	■	-	■	■	■	■	-	96
17	Proximity sensor SME/SMT-10	8 ... 63	■	-	■	■	■	■	-	96
18	Right-angle clevis foot LQG	32 ... 63	■	-	■	■	■	■	-	87
19	Rod clevis SGA	32 ... 63	■	-	■	■	■	■	-	86
20	Clevis foot LBG	32 ... 63	■	-	■	■	■	■	-	87
21	Bellows kit <sup>3)</sup> DADB	12 ... 63	■	-	■	■	-	-	-	88
22	Guide unit FEN	8 ... 25	■	-	■	■	-	-	■	87
23	Hex nut MSK	16 ... 25	■	-	■	■	■	■	■	86

 Note

- Cannot be used on the bearing cap in combination with bellows kit DADB.
  - Only push-in fittings or one-way flow control valves with cylindrical connecting thread (M or G thread) may be used for the compressed air ports in conjunction with the DSNUP.
  - The bellows kit protects the cylinder (piston rod, seal and bearings) against a wide range of media and thus prevents premature wear.
- It can only be used in combination with an extended piston rod (K8).

**- 7 - Type discontinued DSNUP/DSN/ESN  
Available up until 2017**

**FESTO**

**Round cylinders DSNU/DSNUP/DSN/ESNU/ESN**

Type codes

		DSNU	-	25	-	80	-	PPV	-	A	-	MQ
<b>Type</b>												
Double-acting												
DSNU/DSN	Round cylinder											
Single-acting												
ESNU/ESN	Round cylinder											
<b>Piston Ø [mm]</b>												
<b>Stroke [mm]</b>												
<b>Cushioning</b>												
P	Flexible cushioning rings/pads at both ends											
PPV	Pneumatic cushioning, adjustable at both ends											
PPS	Pneumatic cushioning, self-adjusting at both ends											
<b>Position sensing</b>												
A	Via proximity sensor											
<b>Variant</b>												
MQ	Lateral air connection											
MA	Axial air connection											
MH	With mounting flange on bearing cap											

**Modular product system**

Individually configurable

DSNU → 28

ESNU → 66

- Q – Square piston rod (protection against rotation)
- S2 – Through piston rod (piston rod type)
- K2 – Extended male piston rod thread
- K6 – Male piston rod thread, shortened at one end
- K3 – Female piston rod thread (female thread)
- K5 – Special piston rod thread (special thread)
- K8 – Extended piston rod at front
- KP – Clamping unit on the piston rod
- S6 – Heat-resistant seals for temperatures up to 120 °C (temperature resistance)
- S10 – Slow speed (constant motion at low piston rod speeds)
- S11 – Low friction
- EX4 – ATEX certification II 2GD
- R3 – All external cylinder surfaces conform to corrosion resistance class CRC 3 (corrosion protection)
- R8 – Dust protection (wiper seal) 32 ... 63 mm
- A6 – Metal wiper seal 32 ... 63 mm

- 2 - Type discontinued DSNUP/DSN/ESN  
Available up until 2017

## Standard cylinders DSNU/DSNUP/DSN/ESNU/ESN

FESTO

Type codes

		DSNUP	-	20	-	50	-	P	-	A
<b>Type</b>										
Double-acting										
DSNUP	Round cylinder									
<b>Piston Ø [mm]</b>										
<b>Stroke [mm]</b>										
<b>Cushioning</b>										
P	Flexible cushioning rings/pads at both ends									
<b>Position sensing</b>										
A	Via proximity sensor									

# Round cylinders DSNU

Technical data

FESTO

Function  
P cushioning

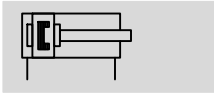

PPV cushioning

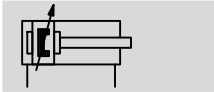

PPS cushioning

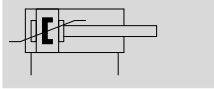

⊘ - Diameter  
8 ... 25 mm  
ISO 6432

⊘ - Diameter  
32 ... 63 mm

┆ - Stroke length  
1 ... 500 mm

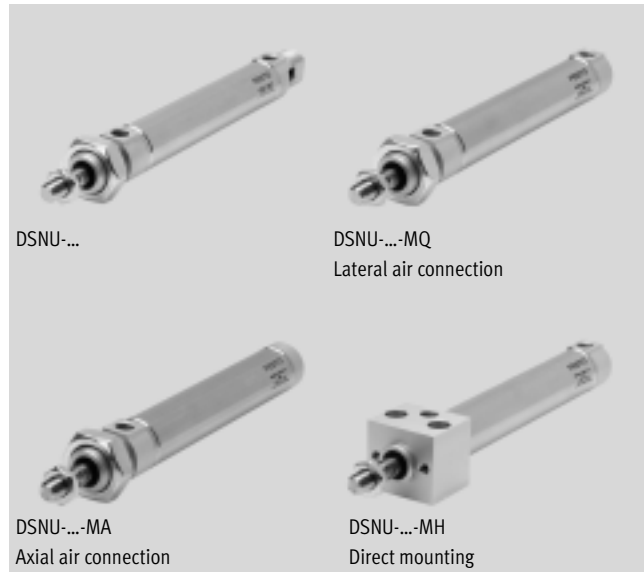

General technical data											
Piston ∅	8	10	12	16	20	25	32	40	50	63	
Conforms	ISO 6432						-				
Pneumatic connection	M5	M5	M5	M5	G1/8	G1/8	G1/8	G1/4	G1/4	G3/8	
Piston rod thread	M4	M4	M6	M6	M8	M10x1.25	M10x1,25	M12x1,25	M16x1,5	M16x1,5	
Stroke <sup>1)</sup> [mm]	1 ... 100		1 ... 200		1 ... 320	1 ... 500					
Constructional design	Piston / Piston rod / Cylinder barrel										
Cushioning											
DSNU-...-P	Flexible cushioning rings/pads at both ends										
DSNU-...-PPV	-		Adjustable cushioning at both ends								
DSNU-...-PPS	-		Self-adjusting cushioning at both ends								
Cushioning length											
DSNU-...-PPV [mm]	-		9	12	15	17	14	18	20	21	
DSNU-...-PPS [mm]	-		12	15	17	14	18	20	21		
Position sensing	Via proximity sensor										
Type of mounting	Direct mounting (MH variant only)										
	Via accessories										
Mounting position	Any										

1) Cylinders with position sensing require a minimum stroke of 10 mm to ensure reliable sensing  
Longer strokes on request.

- ¶ - Note: This product conforms to ISO 1179-1 and to ISO 228-1

# Round cylinders DSNU

Technical data

**FESTO**

Operating and environmental conditions										
Piston $\varnothing$	8	10	12	16	20	25	32	40	50	63
Operating medium	Compressed air in accordance with ISO 8573-1:2010 [7:4:4]									
Note on operating/pilot medium	Operation with lubricated medium possible (in which case lubricated operation will always be required)									
Operating pressure										
DSNU-...-	[bar]	1.5 ... 10 <sup>1)</sup>			1 ... 10					
DSNU-...-S10	[bar]	-		1.5 ... 10		1 ... 10		0.5 ... 10		0.4 ... 10
DSNU-...-S11	[bar]	-		0.45 ... 10		0.3 ... 10		0.2 ... 10		
Ambient temperature <sup>2)</sup>										
DSNU-...	[°C]	-20 ... +80								
DSNU-...-S6	[°C]	0 ... +120								
DSNU-...-S10	[°C]	+5 ... +80								
DSNU-...-S11	[°C]	+5 ... +80								
DSNU-...-R3	[°C]	-20 ... +80								
DSNU-...-A6	[°C]	-							-40 ... +150	

- 1) With DSNU-12- ... -PPV (pneumatic cushioning adjustable at both ends): 2 ... 10 bar  
 2) Note operating range of proximity sensors.

Operating and environmental conditions										
Piston $\varnothing$	8	10	12	16	20	25	32	40	50	63
Corrosion resistance class CRC <sup>1)</sup>										
DSNU-...	[°C]	2								
DSNU-...-R3	[°C]	3								
Certification										
DSNU-...-P	Germanischer Lloyd						-			
DSNU-...-PPV	Germanischer Lloyd						-			

- 1) Corrosion resistance class CRC 2 to Festo standard FN 940070  
 Moderate corrosion stress. Indoor applications in which condensation may occur. External visible parts with primarily decorative requirements for the surface and which are in direct contact with the ambient atmosphere typical for industrial applications.  
 Corrosion resistance class CRC 3 to Festo standard FN 940070  
 High corrosion stress. Outdoor exposure under moderate corrosive conditions. External visible parts with primarily functional requirements for the surface and which are in direct contact with a normal industrial environment.

ATEX <sup>1)</sup>	
ATEX category for gas	II 2G
Explosion ignition protection type for gas	c T4
ATEX category for dust	II 2D
Explosion ignition protection type for dust	c 120°C
Explosion-proof temperature rating	-20°C ≤ Ta ≤ +60°C
CE marking (see declaration of conformity)	To EU Explosion Protection Directive (ATEX)

- 1) Make sure that the accessories are suited for ATEX application.

# Round cylinders DSNU

Technical data



Speed [mm/s]		16	20	25	32	40	50	63
Piston Ø		16	20	25	32	40	50	63
Speed with stick-slip-free operation, horizontal, without load, at 6 bar	S10	10 ... 100			8 ... 100			5 ... 100
Minimum speed, advancing	S11	2.7	5.3	<1 <sup>1)</sup>				
Minimum speed, retracting	S11	3.2	4.7	<1 <sup>1)</sup>				

1) Measurements of less than 1 mm/s were not conducted

Force [N] and impact energy [J]		8	10	12	16	20	25	32	40	50	63
Piston Ø		8	10	12	16	20	25	32	40	50	63
Theoretical force at 6 bar, advancing		30	47	68	121	189	295	483	753	1178	1870
Theoretical force at 6 bar, retracting		23	40	51	104	158	247	415	633	990	1682
Max. impact energy at the end positions for flexible cushioning elements <sup>1)</sup>		0.03	0.05	0.07	0.15	0.20	0.30	0.40	0.70	1.00	1.30

1) The values are reduced by approx. 50% at an ambient temperature of 80 °C

## Average piston speed v as a function of payload m in combination with PPS cushionings

Piston Ø 16

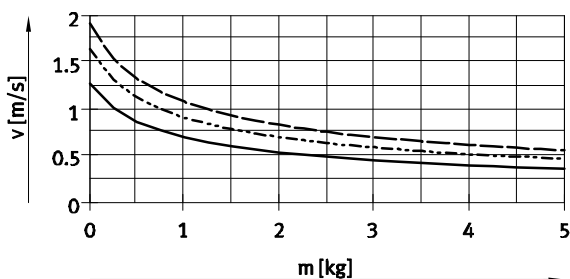

— DSNU-16-50  
 - - - DSNU-16-100  
 - · - DSNU-16-200

Piston Ø 20

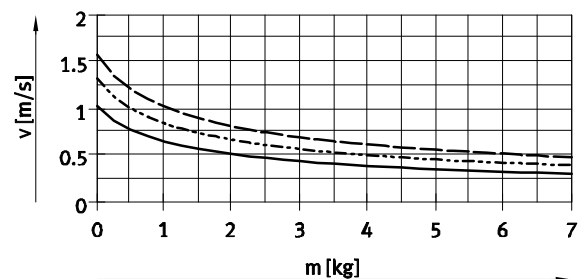

— DSNU-20-50  
 - - - DSNU-20-100  
 - · - DSNU-20-200

Piston Ø 25

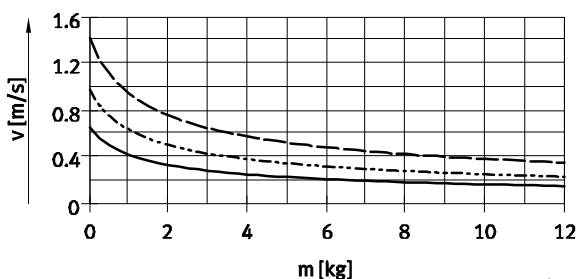

— DSNU-25-50  
 - - - DSNU-25-100  
 - · - DSNU-25-200

Piston Ø 32

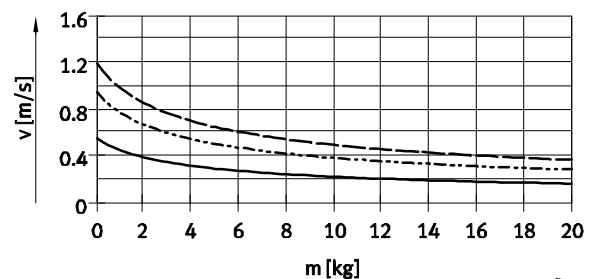

— DSNU-32-50  
 - - - DSNU-32-100  
 - · - DSNU-32-200

# Round cylinders DSNU

Technical data

## Average piston speed $v$ as a function of payload $m$ in combination with PPS cushionings

Piston  $\varnothing$  40

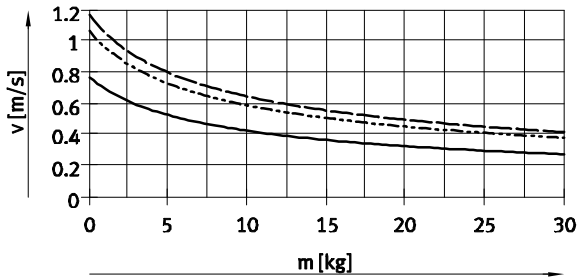

- DSNU-40-50
- - - DSNU-40-100
- · - DSNU-40-200

Piston  $\varnothing$  50

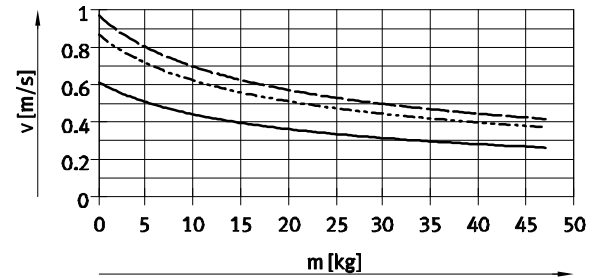

- DSNU-50-50
- - - DSNU-50-100
- · - DSNU-50-200

Piston  $\varnothing$  63

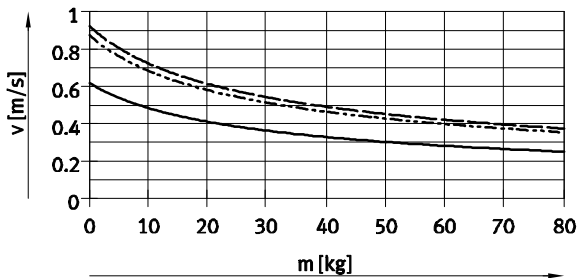

- DSNU-63-50
- - - DSNU-63-100
- · - DSNU-63-200

- · - Note  
 Design software  
 for flexible cushioning elements  
 for PPV cushioning  
 → ProDrive

Additional graphs  
 for PPS cushioning  
 → [www.festo.com](http://www.festo.com)

- · - Note  
 Average piston speed  
 = stroke/movement time

# Round cylinders DSNU

Technical data



Weight [g]										
Piston $\varnothing$	8	10	12	16	20	25	32	40	50	63
Product weight with 0 mm stroke	34.6	37.3	75	89.9	186.8	238	370.5	661	1087	1445
Additional weight per 10 mm stroke	2.4	2.7	4	4.6	7.2	11	15.5	24	40	44
Moving load with 0 mm stroke	7.5	8.5	18.5	23	44	71	121	230	413	459
Moving load per 10 mm stroke	1	1	2	2	4	6	9	16	25	25

## Max. lateral force $F_q$ as a function of stroke length $l$

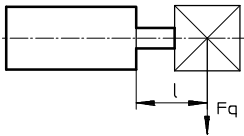

### DSNU-...

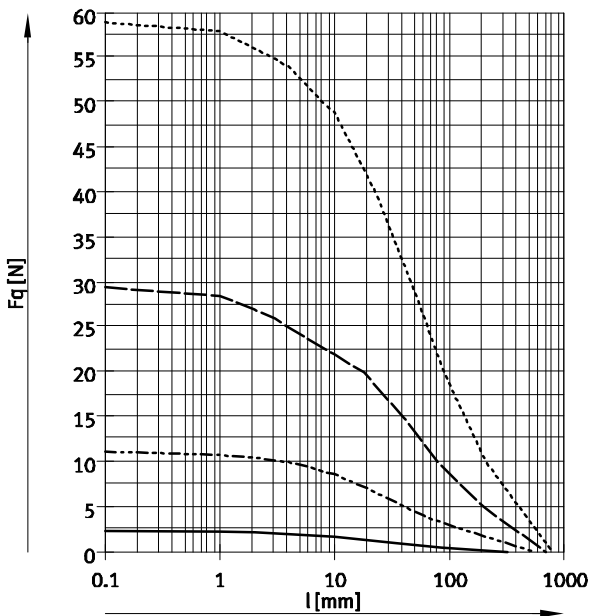

- $\varnothing$  8/10
- - -  $\varnothing$  12/16
- $\varnothing$  20
- - -  $\varnothing$  25

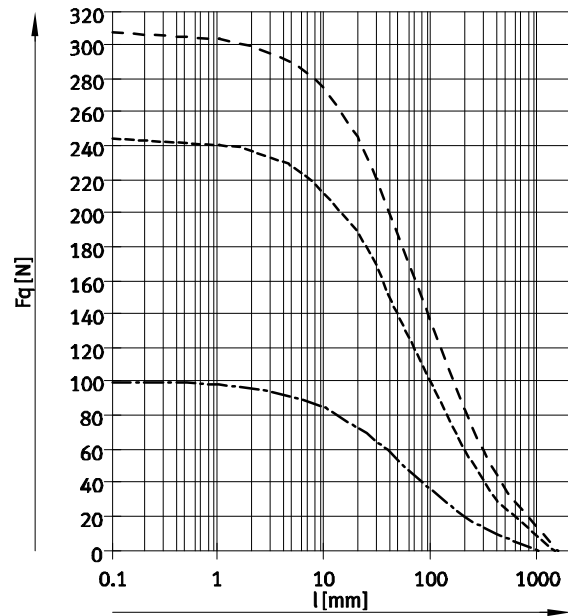

- - -  $\varnothing$  32
- - -  $\varnothing$  40
- - -  $\varnothing$  50/63



# Round cylinders DSNU

Technical data

## Max. lateral force $F_q$ as a function of stroke length $l$

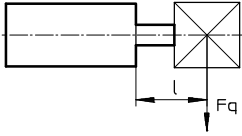

### DSNU-...-S2 – Through piston rod

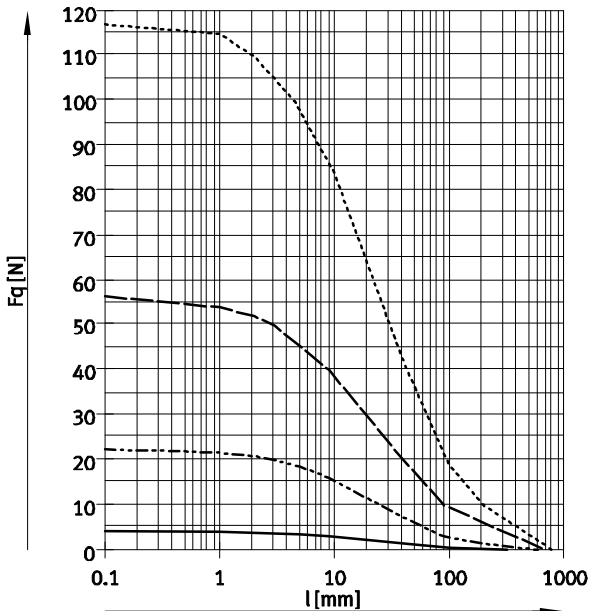

— Ø 8/10      - - - - - Ø 20  
 - · - · - - Ø 12/16      · · · · · Ø 25

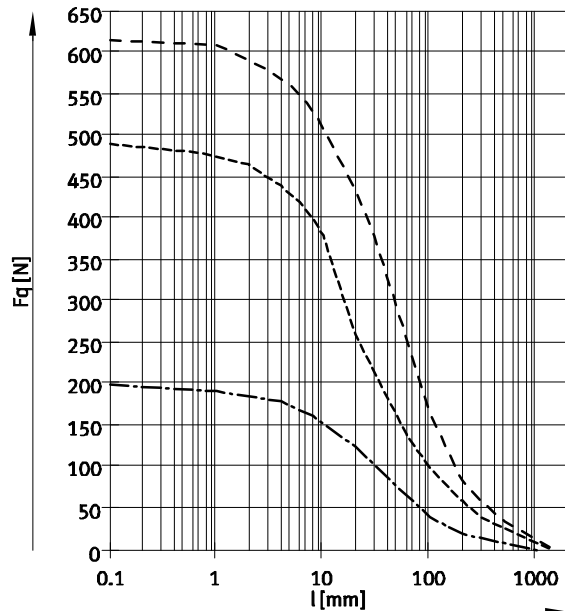

- - - - - Ø 32  
 - - - - - Ø 40  
 - · - · - - Ø 50/63

## Materials

### Sectional view

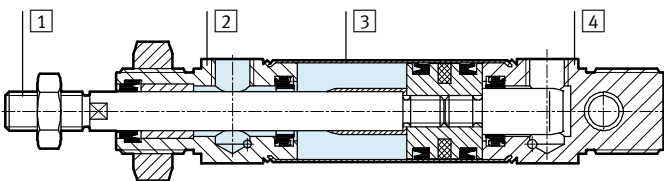

Round cylinder	8 ... 25	32 ... 63
<b>1</b> Piston rod		
DSNU-...	High-alloy steel	
DSNU-...-R3	High-alloy stainless steel	
DSNU-...-A6		Hard-chromium plated tempered steel
<b>2</b> Bearing cap	Anodised aluminium	
<b>3</b> Cylinder barrel	High-alloy stainless steel	
<b>4</b> End cap	Anodised aluminium	
- Seals		
DSNU-...	TPE-U(PU), NBR	
DSNU-...-S6	FPM	
DSNU-...-S10	FPM	FPM, TPE-U(PU)
DSNU-...-S11	FPM	FPM, TPE-U(PU)
DSNU-...-R3	TPE-U(PU), NBR	
Piston rod wiper seal		
DSNU-...-A6	-	CuZn
Note on materials		
DSNU-...-	RoHS compliant	
DSNU-...-S10/11	Contains PWIS (paint-wetting impairment substances)	

# Round cylinders DSNU

Technical data

FESTO

## Dimensions

DSNU-8 ... 25

Download CAD data → [www.festo.com](http://www.festo.com)

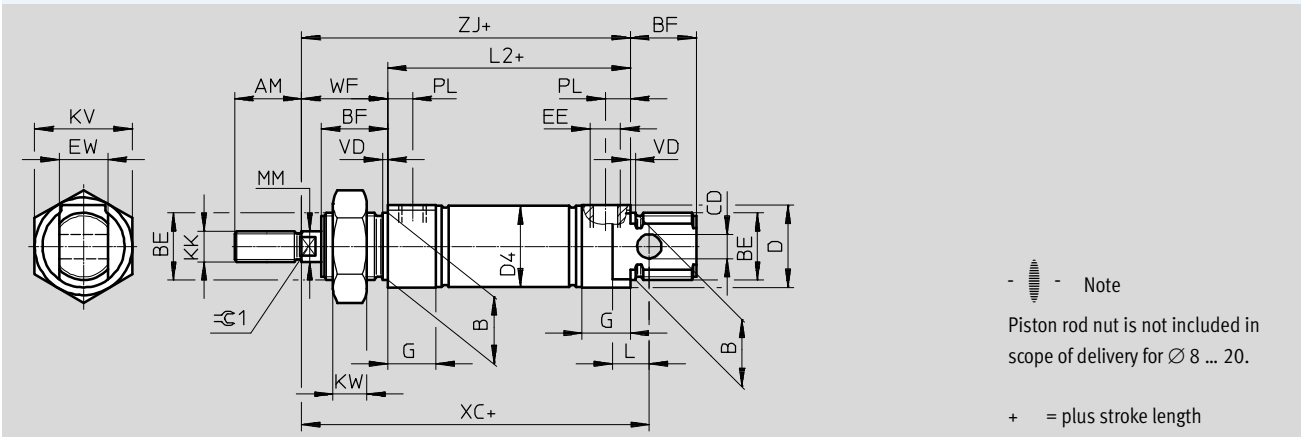

$\varnothing$ [mm]	AM	B $\varnothing$ h9	BE	BF	CD $\varnothing$ H9	D $\varnothing$	D4 $\varnothing$	EE	EW	G	KK	KV
8	12	12	M12x1.25	12	4	15	9.3	M5	8	10	M4	19
10							11.3					
12	16	16	M16x1.5	17	6	20	13.3		12	16	M6	24
16							17.3					
20	20	22	M22x1.5	20	8	27	21.3	G1/8	16	16	M8	32
25	22			22			21.3				M10x1.25	

$\varnothing$ [mm]	KW	L	L2	MM $\varnothing$	PL	VD	WF	XC $\pm 1$	ZJ	$\approx \varnothing 1$
8	6	6	46	4	6	2	16	64	62	-
10			50							
12	8	9	56	6	8.2		22	75	72	5
16			68							
20	11	12	69.5	10	8.2	24	95	92	7	
25			28							104

Note: This product conforms to ISO 1179-1 and to ISO 228-1

# Round cylinders DSNU

Technical data

FESTO

## Dimensions

Download CAD data → [www.festo.com](http://www.festo.com)

DSNU-8 ... 25

MQ – Lateral air connection

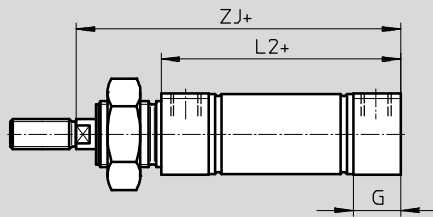

MA – Axial air connection

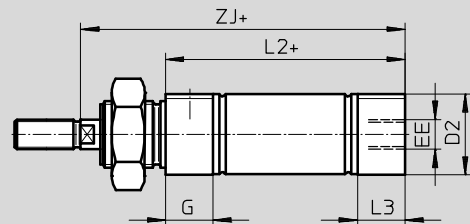

MH – With direct mounting

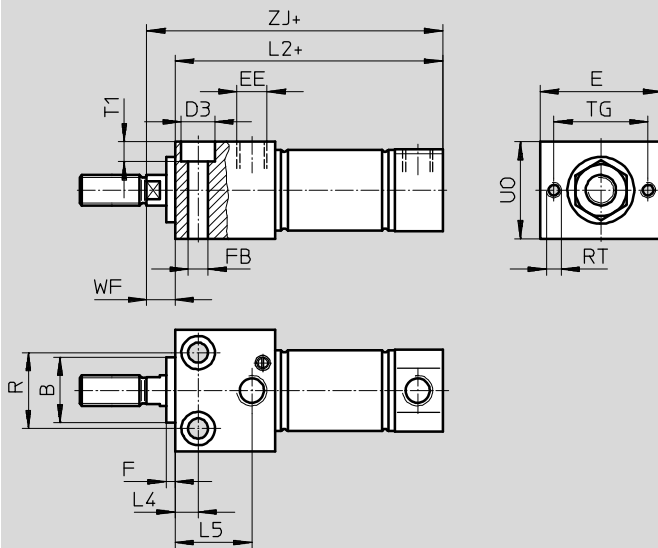

+ = plus stroke length

Ø [mm]	B Ø h9	D2 Ø	D3 Ø	E	EE	F	FB Ø	G	L2		
									DSNU-... -MQ	-MA	-MH
8	12	10.5	6	24	M5	3	3.4	10	46	43.6	53.5
10		12.5								43.1	53.8
12	16	14.5	8	30	G1/8	3	4.5	16	50	47.7	62
16		17.5								56	53.7
20	22	21.7	10	40	G1/8	3	5.5	16	68	66.5	81.5
25		26.7								11	69.5

Ø [mm]	L3	L4	L5	R	RT	TG	T1	UO	WF	ZJ		
										DSNU-... -MQ	-MA	-MH
8	7.6	5	14	12	M3	18	3.4	16	8	62	59.6	61.5
10	7.1										59.1	61.8
12	7.7	6	18.1	16	M4	23	4.5	22	10	72	69.7	72
16											78	75.7
20	14.5	7.5	22.4	22	M5	31	5.5	28	10	92	90.5	91.5
25	14		25.2	25			6.6				32	11

– † – Note: This product conforms to ISO 1179-1 and to ISO 228-1

# Round cylinders DSNU

Technical data

FESTO

## Dimensions

Download CAD data → [www.festo.com](http://www.festo.com)

DSNU-8 ... 25

S2 – Through piston rod

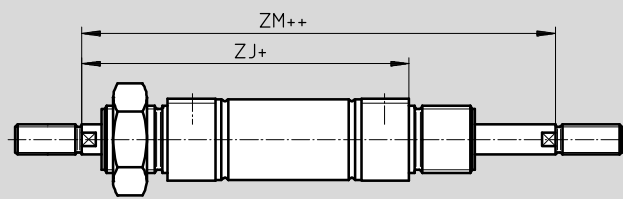

The thread types at both piston rod ends are identical. In combination with variant Q, the left-hand piston rod end is square, the right-hand piston rod end round.

+ = plus stroke length  
++ = plus 2x stroke length

### K2 – Extended male piston rod thread

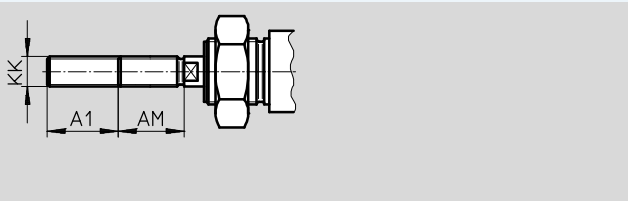

### K6 – Shortened male piston rod thread

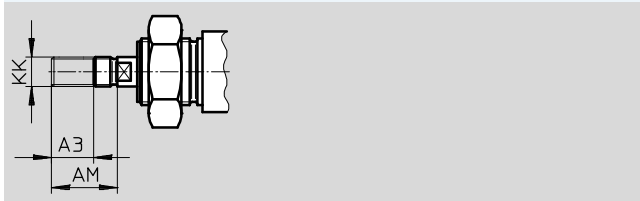

### K3 – Female piston rod thread

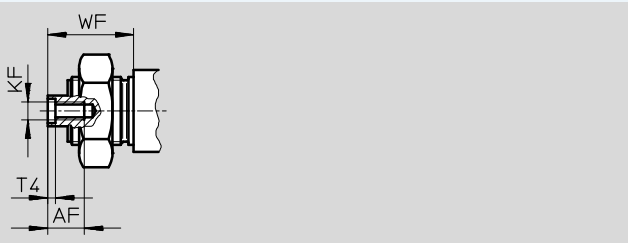

### K5 – Special thread on piston rod

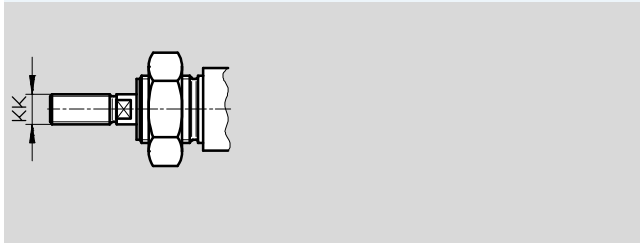

### K8 – Extended piston rod

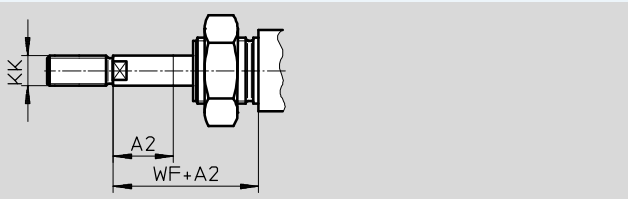

If variant K8 is required in combination with S2, the piston rod will only be extended on one side.

∅ [mm]	A1 max.	A2 max.	A3 max.	AM	AF	KF	KK		T4	WF	ZJ			ZM
							Basic thread	Special thread <sup>1)</sup>			DSNU-...			
											-MQ	-MA	-MH	
8	15	50	4	12	-	-	M4	-	16	62	59.6	61.5	78.4	
10					-	-		-			59.1	61.8		
12	20	100		16	-	-	M6	-	22	72	69.7	72	94	
16					-	-		-			78	75.7	77.8	100
20	25	110	8	20	12	M4	M8	-	2	24	92	90.5	91.5	116
25	35	150		22		M6	M10x1.25	M10	2.6	28	97.5	96.5	97.2	125.5

1) The special threads are only available as male threads. The scope of delivery does not include a hex nut for the piston rod thread.

# Round cylinders DSNU

Technical data

FESTO

## Dimensions

Download CAD data → [www.festo.com](http://www.festo.com)

DSNU-32 ... 63

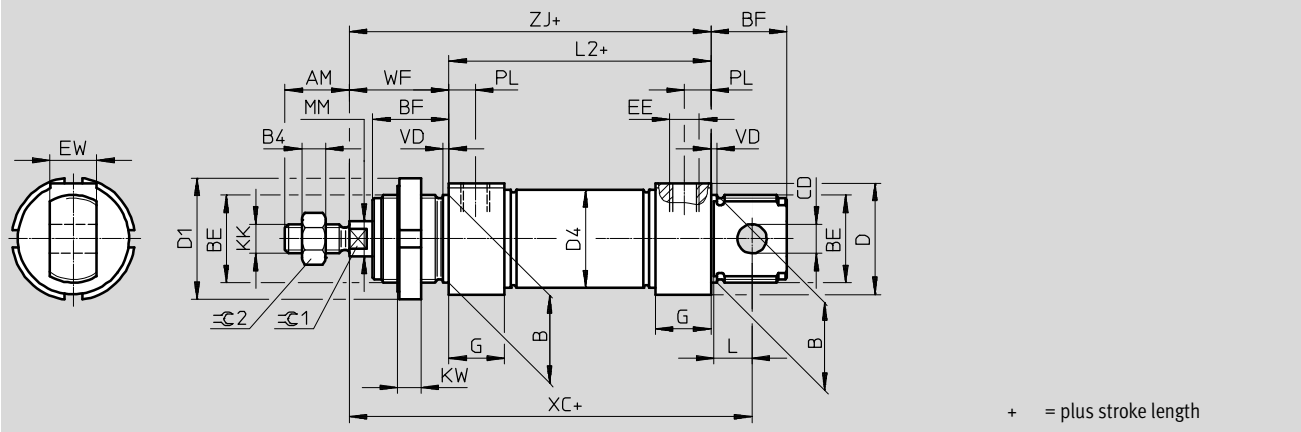

∅	AM	B	B4	BE	BF	CD	D	D1	D4	EE	EW	G
[mm]		∅ h9				∅ E10	∅	∅	∅			
32	22	30	5	M30x1.5	26	10	38	42	33.6	G $\frac{1}{8}$	16	19
40	24	38	6	M38x1.5	30	12	46	50	41.6	G $\frac{1}{4}$	18	25
50	32	45	8	M45x1.5	33	16	57	60	52.4	G $\frac{3}{8}$	21	28
63							70					

∅	KK	KW	L	L2	MM	PL	VD	WF	XC	ZJ	⊖C1	⊖C2
[mm]					∅				±1			
32	M10x1.25	8	13	695	12	9	2	34	117.5	103.5	10	16
40	M12x1.25	10	15	84.6	16	12	3	39	139.6	123.6	13	18
50	M16x1.5		16	86.2	20			13	44	147.2	130.2	17
63		94.2		45		156.2	139.2					

# Round cylinders DSNU

Technical data



## Dimensions

Download CAD data → [www.festo.com](http://www.festo.com)

DSNU-32 ... 63

MQ – Lateral air connection

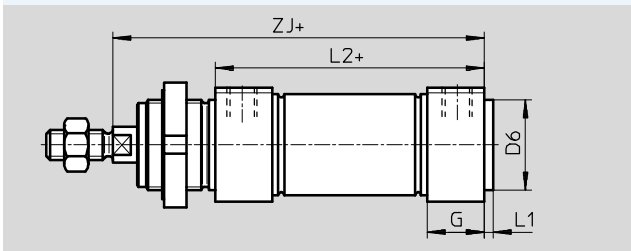

MA – Axial air connection

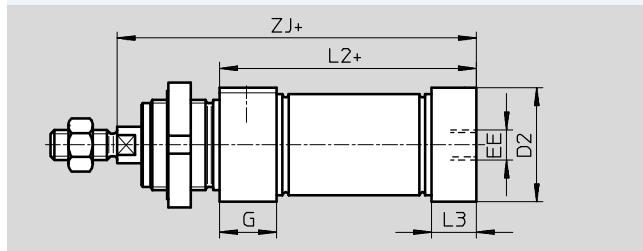

MH – Direct mounting

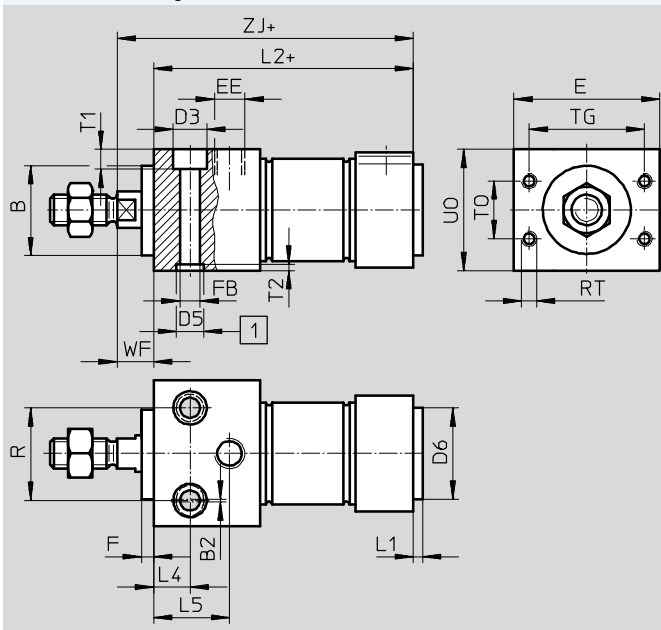

- 1 Centring holes  
(2 centring sleeves included in scope of delivery)  
+ = plus stroke length

Ø [mm]	B Ø h9	B2	E	EE	G	F	FB Ø	D2 Ø	D3	D5 Ø	D6 Ø	L1	L2		
													DSNU-... -MQ	-MA	-MH
32	30	1	48	G $\frac{1}{8}$	19	4	6.6	34	11	9	30	3	69.5	65.5	85.5
40	38		54	G $\frac{1}{4}$	25		9	42	14	12	38	4	84.6	77.6	104.6
50	45	2	64	G $\frac{3}{8}$	28	4	11	53	18	15	45	4	86.2	86.2	109.2
63			72					66					52	72	94.2

Ø [mm]	L3	L4	L5	R	RT	T0	T1	T2	TG	U0	WF	ZJ		
												DSNU-... -MQ	-MA	-MH
32	15	12	25	30	M5	19	6.6	2.1	38	40	12	103.5	99.5	97.5
40	18	15	32	38		24	9	2.6	42	48		123.6	116.5	116.6
50	25		35	42	M6	32	15	11	3.1	50	58	130.2	130.2	124.2
63	28	36	44	M8	36	72				139.2	139.2	132.2		

# Round cylinders DSNU

Technical data

FESTO

## Dimensions

Download CAD data → [www.festo.com](http://www.festo.com)

DSNU-32 ... 63

S2 – Through piston rod

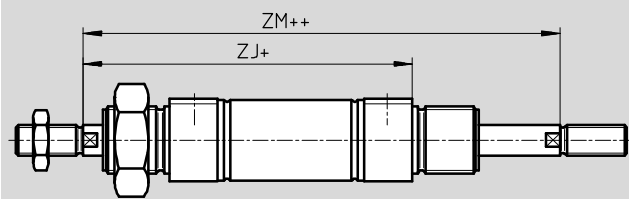

- - Note

The thread types at both piston rod ends are identical. In combination with variant Q, the left-hand piston rod end is square, the right-hand piston rod end round.

+ = plus stroke length

++ = plus 2x stroke length

### K2 – Extended male piston rod thread

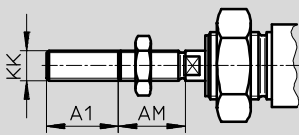

### K6 – Shortened male piston rod thread

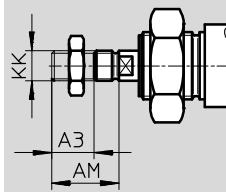

### K3 – Female piston rod thread

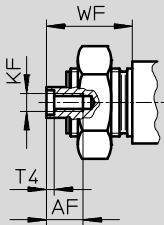

### K5 – Special piston rod thread

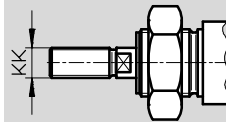

### K8 – Extended piston rod

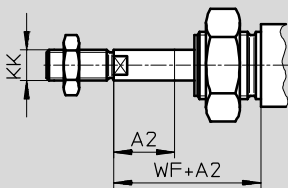

- - Note

If variant K8 is required in combination with S2, the piston rod will only be extended on one side.

∅ [mm]	A1 max.	A2 max.	A3 max.	AF	AM	KF	KK		T4	WF	ZJ			ZM
							Basic thread	Special thread <sup>1)</sup>			DSNU-...			
											-MQ	-MA	-MH	
32	35	500	8	12	22	M6	M10x1.25	M10	2.6	34	103.5	99.5	97.5	137.5
40					24	M8	M12x1.25	M12	3.3	39	123.6	111.6	116.6	162.6
50	70		10	16	32	M10	M16x1.5	M16	4.7	44	130.2	130.2	124.2	174.2
63										45	139.2	139.2	132.2	184.2

1) The special threads are only available as male threads. The scope of delivery does not include a hex nut for the piston rod thread

# Round cylinders DSNU

Technical data

**FESTO**

Ordering data							
Piston $\varnothing$ [mm]	Stroke [mm]	P – Flexible cushioning rings/pads at both ends A – With position sensing		PPV – Pneumatic cushioning, adjustable at both ends A – With position sensing		PPS – Pneumatic cushioning, self-adjusting at both ends A – With position sensing	
		Part No.	Type	Part No.	Type	Part No.	Type
8	10	19177	DSNU-8-10-P-A	-		-	
	15	1908247	DSNU-8-15-P-A				
	20	1908248	DSNU-8-20-P-A				
	25	19178	DSNU-8-25-P-A				
	30	1908249	DSNU-8-30-P-A				
	40	19179	DSNU-8-40-P-A				
	50	19180	DSNU-8-50-P-A				
	60	1908250	DSNU-8-60-P-A				
	80	19181	DSNU-8-80-P-A				
	100	19182	DSNU-8-100-P-A				
10	10	19183	DSNU-10-10-P-A	-		-	
	15	1908251	DSNU-10-15-P-A				
	20	1908252	DSNU-10-20-P-A				
	25	19184	DSNU-10-25-P-A				
	30	1908253	DSNU-10-30-P-A				
	40	19185	DSNU-10-40-P-A				
	50	19186	DSNU-10-50-P-A				
	60	1908254	DSNU-10-60-P-A				
	80	19187	DSNU-10-80-P-A				
	100	19188	DSNU-10-100-P-A				
12	10	19189	DSNU-12-10-P-A	-		-	
	15	1908255	DSNU-12-15-P-A				
	20	1908256	DSNU-12-20-P-A				
	25	19190	DSNU-12-25-P-A				
	30	1908257	DSNU-12-30-P-A				
	40	19191	DSNU-12-40-P-A				
	50	19192	DSNU-12-50-P-A				
	60	1908258	DSNU-12-60-P-A				
	80	19193	DSNU-12-80-P-A				
	100	19194	DSNU-12-100-P-A				
	125	19195	DSNU-12-125-P-A				
	160	19196	DSNU-12-160-P-A				
	200	19197	DSNU-12-200-P-A				
16	10	19198	DSNU-16-10-P-A	1908266	DSNU-16-10-PPV-A	1908274	DSNU-16-10-PPS-A
	15	1908259	DSNU-16-15-P-A	1908267	DSNU-16-15-PPV-A	1908275	DSNU-16-15-PPS-A
	20	1908260	DSNU-16-20-P-A	1908268	DSNU-16-20-PPV-A	1908276	DSNU-16-20-PPS-A
	25	19199	DSNU-16-25-P-A	33973	DSNU-16-25-PPV-A	559263	DSNU-16-25-PPS-A
	30	1908261	DSNU-16-30-P-A	1908269	DSNU-16-30-PPV-A	1908277	DSNU-16-30-PPS-A
	35	1908262	DSNU-16-35-P-A	1908270	DSNU-16-35-PPV-A	1908278	DSNU-16-35-PPS-A
	40	19200	DSNU-16-40-P-A	19229	DSNU-16-40-PPV-A	559264	DSNU-16-40-PPS-A
	50	19201	DSNU-16-50-P-A	19230	DSNU-16-50-PPV-A	559265	DSNU-16-50-PPS-A
	60	1908263	DSNU-16-60-P-A	1908271	DSNU-16-60-PPV-A	1908279	DSNU-16-60-PPS-A
	70	1908264	DSNU-16-70-P-A	1908272	DSNU-16-70-PPV-A	1908280	DSNU-16-70-PPS-A
	80	19202	DSNU-16-80-P-A	19231	DSNU-16-80-PPV-A	559266	DSNU-16-80-PPS-A
	100	19203	DSNU-16-100-P-A	19232	DSNU-16-100-PPV-A	559267	DSNU-16-100-PPS-A
	125	19204	DSNU-16-125-P-A	19233	DSNU-16-125-PPV-A	559268	DSNU-16-125-PPS-A
	150	1908265	DSNU-16-150-P-A	1908273	DSNU-16-150-PPV-A	1908281	DSNU-16-150-PPS-A
	160	19205	DSNU-16-160-P-A	19234	DSNU-16-160-PPV-A	559269	DSNU-16-160-PPS-A
	200	19206	DSNU-16-200-P-A	19235	DSNU-16-200-PPV-A	559270	DSNU-16-200-PPS-A



# Round cylinders DSNU

Technical data

FESTO

Ordering data							
Piston $\varnothing$ [mm]	Stroke [mm]	P – Flexible cushioning rings/pads at both ends		PPV – Pneumatic cushioning, adjustable at both ends		PPS – Pneumatic cushioning, self-adjusting at both ends	
		A – With position sensing		A – With position sensing		A – With position sensing	
		Part No.	Type	Part No.	Type	Part No.	Type
20	10	19207	DSNU-20-10-P-A	1908289	DSNU-20-10-PPV-A	1908297	DSNU-20-10-PPS-A
	15	1908282	DSNU-20-15-P-A	1908290	DSNU-20-15-PPV-A	1908298	DSNU-20-15-PPS-A
	20	1908283	DSNU-20-20-P-A	1908291	DSNU-20-20-PPV-A	1908299	DSNU-20-20-PPS-A
	25	19208	DSNU-20-25-P-A	33974	DSNU-20-25-PPV-A	559271	DSNU-20-25-PPS-A
	30	1908284	DSNU-20-30-P-A	1908292	DSNU-20-30-PPV-A	1908300	DSNU-20-30-PPS-A
	35	1908285	DSNU-20-35-P-A	1908293	DSNU-20-35-PPV-A	1908301	DSNU-20-35-PPS-A
	40	19209	DSNU-20-40-P-A	19236	DSNU-20-40-PPV-A	559272	DSNU-20-40-PPS-A
	50	19210	DSNU-20-50-P-A	19237	DSNU-20-50-PPV-A	559273	DSNU-20-50-PPS-A
	60	1908286	DSNU-20-60-P-A	1908294	DSNU-20-60-PPV-A	1908302	DSNU-20-60-PPS-A
	70	1908287	DSNU-20-70-P-A	1908295	DSNU-20-70-PPV-A	1908303	DSNU-20-70-PPS-A
	80	19211	DSNU-20-80-P-A	19238	DSNU-20-80-PPV-A	559274	DSNU-20-80-PPS-A
	100	19212	DSNU-20-100-P-A	19239	DSNU-20-100-PPV-A	559275	DSNU-20-100-PPS-A
	125	19213	DSNU-20-125-P-A	19240	DSNU-20-125-PPV-A	559276	DSNU-20-125-PPS-A
	150	1908288	DSNU-20-150-P-A	1908296	DSNU-20-150-PPV-A	1908304	DSNU-20-150-PPS-A
	160	19214	DSNU-20-160-P-A	19241	DSNU-20-160-PPV-A	559277	DSNU-20-160-PPS-A
	200	19215	DSNU-20-200-P-A	19242	DSNU-20-200-PPV-A	559278	DSNU-20-200-PPS-A
	250	19216	DSNU-20-250-P-A	19243	DSNU-20-250-PPV-A	559279	DSNU-20-250-PPS-A
	300	19217	DSNU-20-300-P-A	19244	DSNU-20-300-PPV-A	559280	DSNU-20-300-PPS-A
320	34718	DSNU-20-320-P-A	34720	DSNU-20-320-PPV-A	559281	DSNU-20-320-PPS-A	
25	10	19218	DSNU-25-10-P-A	1908312	DSNU-25-10-PPV-A	1908320	DSNU-25-10-PPS-A
	15	1908305	DSNU-25-15-P-A	1908313	DSNU-25-15-PPV-A	1908321	DSNU-25-15-PPS-A
	20	1908306	DSNU-25-20-P-A	1908314	DSNU-25-20-PPV-A	1908322	DSNU-25-20-PPS-A
	25	19219	DSNU-25-25-P-A	33975	DSNU-25-25-PPV-A	559282	DSNU-25-25-PPS-A
	30	1908307	DSNU-25-30-P-A	1908315	DSNU-25-30-PPV-A	1908323	DSNU-25-30-PPS-A
	35	1908308	DSNU-25-35-P-A	1908316	DSNU-25-35-PPV-A	1908324	DSNU-25-35-PPS-A
	40	19220	DSNU-25-40-P-A	19245	DSNU-25-40-PPV-A	559283	DSNU-25-40-PPS-A
	50	19221	DSNU-25-50-P-A	19246	DSNU-25-50-PPV-A	559284	DSNU-25-50-PPS-A
	60	1908309	DSNU-25-60-P-A	1908317	DSNU-25-60-PPV-A	1908325	DSNU-25-60-PPS-A
	70	1908310	DSNU-25-70-P-A	1908318	DSNU-25-70-PPV-A	1908326	DSNU-25-70-PPS-A
	80	19222	DSNU-25-80-P-A	19247	DSNU-25-80-PPV-A	559285	DSNU-25-80-PPS-A
	100	19223	DSNU-25-100-P-A	19248	DSNU-25-100-PPV-A	559286	DSNU-25-100-PPS-A
	125	19224	DSNU-25-125-P-A	19249	DSNU-25-125-PPV-A	559287	DSNU-25-125-PPS-A
	150	1908311	DSNU-25-150-P-A	1908319	DSNU-25-150-PPV-A	1908327	DSNU-25-150-PPS-A
	160	19225	DSNU-25-160-P-A	19250	DSNU-25-160-PPV-A	559288	DSNU-25-160-PPS-A
	200	19226	DSNU-25-200-P-A	19251	DSNU-25-200-PPV-A	559289	DSNU-25-200-PPS-A
	250	19227	DSNU-25-250-P-A	19252	DSNU-25-250-PPV-A	559290	DSNU-25-250-PPS-A
	300	19228	DSNU-25-300-P-A	19253	DSNU-25-300-PPV-A	559291	DSNU-25-300-PPS-A
320	34719	DSNU-25-320-P-A	34721	DSNU-25-320-PPV-A	559292	DSNU-25-320-PPS-A	
400	35191	DSNU-25-400-P-A	35193	DSNU-25-400-PPV-A	559293	DSNU-25-400-PPS-A	
500	35192	DSNU-25-500-P-A	35194	DSNU-25-500-PPV-A	559294	DSNU-25-500-PPS-A	

# Round cylinders DSNU

Technical data

FESTO

Ordering data							
Piston $\varnothing$ [mm]	Stroke [mm]	P – Flexible cushioning rings/ pads at both ends A – With position sensing		PPV – Pneumatic cushioning, adjustable at both ends A – With position sensing		PPS – Pneumatic cushioning, self-adjusting at both ends A – With position sensing	
		Part No.	Type	Part No.	Type	Part No.	Type
32	25	195980	DSNU-32-25-P-A	196020	DSNU-32-25-PPV-A	559295	DSNU-32-25-PPS-A
	40	195981	DSNU-32-40-P-A	196021	DSNU-32-40-PPV-A	559296	DSNU-32-40-PPS-A
	50	195982	DSNU-32-50-P-A	196022	DSNU-32-50-PPV-A	559297	DSNU-32-50-PPS-A
	80	195983	DSNU-32-80-P-A	196023	DSNU-32-80-PPV-A	559298	DSNU-32-80-PPS-A
	100	195984	DSNU-32-100-P-A	196024	DSNU-32-100-PPV-A	559299	DSNU-32-100-PPS-A
	125	195985	DSNU-32-125-P-A	196025	DSNU-32-125-PPV-A	559300	DSNU-32-125-PPS-A
	160	195986	DSNU-32-160-P-A	196026	DSNU-32-160-PPV-A	559301	DSNU-32-160-PPS-A
	200	195987	DSNU-32-200-P-A	196027	DSNU-32-200-PPV-A	559302	DSNU-32-200-PPS-A
	250	195988	DSNU-32-250-P-A	196028	DSNU-32-250-PPV-A	559303	DSNU-32-250-PPS-A
	320	195989	DSNU-32-320-P-A	196029	DSNU-32-320-PPV-A	559304	DSNU-32-320-PPS-A
40	25	195990	DSNU-40-25-P-A	196030	DSNU-40-25-PPV-A	559305	DSNU-40-25-PPS-A
	40	195991	DSNU-40-40-P-A	196031	DSNU-40-40-PPV-A	559306	DSNU-40-40-PPS-A
	50	195992	DSNU-40-50-P-A	196032	DSNU-40-50-PPV-A	559307	DSNU-40-50-PPS-A
	80	195993	DSNU-40-80-P-A	196033	DSNU-40-80-PPV-A	559308	DSNU-40-80-PPS-A
	100	195994	DSNU-40-100-P-A	196034	DSNU-40-100-PPV-A	559309	DSNU-40-100-PPS-A
	125	195995	DSNU-40-125-P-A	196035	DSNU-40-125-PPV-A	559310	DSNU-40-125-PPS-A
	160	195996	DSNU-40-160-P-A	196036	DSNU-40-160-PPV-A	559311	DSNU-40-160-PPS-A
	200	195997	DSNU-40-200-P-A	196037	DSNU-40-200-PPV-A	559312	DSNU-40-200-PPS-A
	250	195998	DSNU-40-250-P-A	196038	DSNU-40-250-PPV-A	559313	DSNU-40-250-PPS-A
	320	195999	DSNU-40-320-P-A	196039	DSNU-40-320-PPV-A	559314	DSNU-40-320-PPS-A
50	25	196000	DSNU-50-25-P-A	196040	DSNU-50-25-PPV-A	559315	DSNU-50-25-PPS-A
	40	196001	DSNU-50-40-P-A	196041	DSNU-50-40-PPV-A	559316	DSNU-50-40-PPS-A
	50	196002	DSNU-50-50-P-A	196042	DSNU-50-50-PPV-A	559317	DSNU-50-50-PPS-A
	80	196003	DSNU-50-80-P-A	196043	DSNU-50-80-PPV-A	559318	DSNU-50-80-PPS-A
	100	196004	DSNU-50-100-P-A	196044	DSNU-50-100-PPV-A	559319	DSNU-50-100-PPS-A
	125	196005	DSNU-50-125-P-A	196045	DSNU-50-125-PPV-A	559320	DSNU-50-125-PPS-A
	160	196006	DSNU-50-160-P-A	196046	DSNU-50-160-PPV-A	559321	DSNU-50-160-PPS-A
	200	196007	DSNU-50-200-P-A	196047	DSNU-50-200-PPV-A	559322	DSNU-50-200-PPS-A
	250	196008	DSNU-50-250-P-A	196048	DSNU-50-250-PPV-A	559323	DSNU-50-250-PPS-A
	320	196009	DSNU-50-320-P-A	196049	DSNU-50-320-PPV-A	559324	DSNU-50-320-PPS-A
63	25	196010	DSNU-63-25-P-A	196050	DSNU-63-25-PPV-A	559325	DSNU-63-25-PPS-A
	40	196011	DSNU-63-40-P-A	196051	DSNU-63-40-PPV-A	559326	DSNU-63-40-PPS-A
	50	196012	DSNU-63-50-P-A	196052	DSNU-63-50-PPV-A	559327	DSNU-63-50-PPS-A
	80	196013	DSNU-63-80-P-A	196053	DSNU-63-80-PPV-A	559328	DSNU-63-80-PPS-A
	100	196014	DSNU-63-100-P-A	196054	DSNU-63-100-PPV-A	559329	DSNU-63-100-PPS-A
	125	196015	DSNU-63-125-P-A	196055	DSNU-63-125-PPV-A	559330	DSNU-63-125-PPS-A
	160	196016	DSNU-63-160-P-A	196056	DSNU-63-160-PPV-A	559331	DSNU-63-160-PPS-A
	200	196017	DSNU-63-200-P-A	196057	DSNU-63-200-PPV-A	559332	DSNU-63-200-PPS-A
	250	196018	DSNU-63-250-P-A	196058	DSNU-63-250-PPV-A	559333	DSNU-63-250-PPS-A
	320	196019	DSNU-63-320-P-A	196059	DSNU-63-320-PPV-A	559334	DSNU-63-320-PPS-A

# Round cylinders DSNU

Technical data

Ordering data			
Piston $\varnothing$ [mm]	Stroke [mm]	PPS – Pneumatic cushioning, self-adjustable at both ends Without position sensing	
		Part No.	Type
16	40	559234	DSNU-16-40-PPS
	50	559235	DSNU-16-50-PPS
	80	559236	DSNU-16-80-PPS
	100	559237	DSNU-16-100-PPS
	125	559238	DSNU-16-125-PPS
	160	559239	DSNU-16-160-PPS
	200	559240	DSNU-16-200-PPS
20	40	559241	DSNU-20-40-PPS
	50	559242	DSNU-20-50-PPS
	80	559243	DSNU-20-80-PPS
	100	559244	DSNU-20-100-PPS
	125	559245	DSNU-20-125-PPS
	160	559246	DSNU-20-160-PPS
	200	559247	DSNU-20-200-PPS
	250	559248	DSNU-20-250-PPS
	300	559249	DSNU-20-300-PPS
	320	559250	DSNU-20-320-PPS
25	40	559251	DSNU-25-40-PPS
	50	559252	DSNU-25-50-PPS
	80	559253	DSNU-25-80-PPS
	100	559254	DSNU-25-100-PPS
	125	559255	DSNU-25-125-PPS
	160	559256	DSNU-25-160-PPS
	200	559257	DSNU-25-200-PPS
	250	559258	DSNU-25-250-PPS
	300	559259	DSNU-25-300-PPS
	320	559260	DSNU-25-320-PPS
	500	559262	DSNU-25-500-PPS

Ordering data					
Piston $\varnothing$ [mm]	Stroke [mm]	P – Flexible cushioning rings/pads at both ends A – With position sensing		PPV – Pneumatic cushioning, adjustable at both ends A – With position sensing	
		Part No.	Type	Part No.	Type
Variable stroke lengths				Variable stroke lengths	
8	10 ... 100	14326	DSNU-8-...-P-A	-	
10	10 ... 100	14325	DSNU-10-...-P-A	-	
12	10 ... 200	14324	DSNU-12-...-P-A	-	
16	10 ... 200	14323	DSNU-16-...-P-A	14320	DSNU-16-...-PPV-A
20	10 ... 320	14328	DSNU-20-...-P-A	14321	DSNU-20-...-PPV-A
25	10 ... 500	14327	DSNU-25-...-P-A	14322	DSNU-25-...-PPV-A

 Note  
Additional variants can be configured and ordered via the DSNU product modules → 28.

# Round cylinders DSNU

Ordering data – Modular products



Ordering table									
Size	8	10	12	16	20	25	Condi- tions	Code	Enter code
<b>M</b> Module No.	<b>193986</b>	<b>193987</b>	<b>193988</b>	<b>193989</b>	<b>193990</b>	<b>193991</b>			
Function	Standard cylinder, double-acting, based on ISO 6432							<b>DSNU</b>	DSNU
Piston Ø [mm]	8	10	12	16	20	25		-...	
Stroke [mm]	1 ... 100		1 ... 200		1 ... 320	1 ... 500	<b>1</b>	-...	
Cushioning	Flexible cushioning rings/pads at both ends								<b>-P</b>
	-		-		Pneumatic cushioning, adjustable at both ends			<b>2</b>	<b>-PPV</b>
	-		-		Pneumatic cushioning, self-adjusting at both ends			<b>3</b>	<b>-PPS</b>
<b>O</b> Position sensing	Via proximity sensor							<b>4</b>	<b>-A</b>
Cylinder end cap	Lateral supply port, end cap							<b>5</b>	<b>-MQ</b>
	Axial supply port, end cap							<b>5</b>	<b>-MA</b>
	With mounting flange at front (direct mounting), bearing cap							<b>6</b>	<b>-MH</b>
<b>↓</b> Type of piston rod	Through piston rod							<b>7</b>	<b>-S2</b>

**1** -... Longer strokes on request

**2** **PPV** Not with MA.

In combination with S6, S10, S11 not with piston Ø 12 mm

**3** **PPS** Not with MA, MH, S6, S10, S11

and not with combination MQ-R3

**4** **A** Minimum stroke: 10 mm

**5** **MQ, MA** Not with S2, S10, S11

**6** **MH** Not with combination S6-R3.

Not with S10, S11

**7** **S2** Not with S10, S11



Note

The bellows kit DADB must not be used in combination with the variant MH.

The running characteristics change slightly when the bellows kit DADB is combined with the variant S10 or S11.

**M** Mandatory data

**O** Options

Transfer order code

**DSNU** -  -  -  -  -  -

# Round cylinders DSNU

Ordering data – Modular products

Ordering table										
Size	8	10	12	16	20	25	Condi- tions	Code	Enter code	
↓										
<input type="checkbox"/> Extended male thread	Extended male piston rod thread									
<input type="checkbox"/> [mm]	1 ... 15		1 ... 20		1 ... 25	1 ... 35	<input type="checkbox"/>	-...K2		
Shortened male thread	Shortened male piston rod thread									
[mm]	1 ... 4				1 ... 8	1 ... 10	<input type="checkbox"/>	-...K6		
Female thread	Female piston rod thread									
	-	-	-	-	(M4)	(M6)	<input type="checkbox"/>	-K3		
Special thread	Piston rod with special thread									
	-	-	-	-	-	M10		-“...”K5		
Piston rod extended at one end	Extended piston rod at one end									
[mm]	1 ... 50		1 ... 100		1 ... 110	1 ... 150		...K8		
Temperature resistance	Heat-resistant seals for temperatures up to 120 °C						<input type="checkbox"/>	-S6		
Slow speed (constant motion)	-	-	Slow speed (constant motion at low piston speeds)				<input type="checkbox"/>	-S10		
Low friction	-	-	Low friction				<input type="checkbox"/>	-S11		
Corrosion protection	-	-	High corrosion protection					-R3		
EU certification	II 2GD						<input type="checkbox"/>	-EX4		

- K2** Not with K3, K6
- K6** Not with K3
- K3** Not with K5
- S6** Not with S10, S11

- S10** Not with S11, R3
- S11** Not with R3
- EX4** Not with S6

- M** Mandatory data
- O** Options

**Transfer order code**

-  -  -  -  -  -  -  -  -  -  -

# Round cylinders DSNU

Ordering data – Modular products



Ordering table							
Size	32	40	50	63	Condi- tions	Code	Enter code
<b>M</b> Module No.	<b>193992</b>	<b>193993</b>	<b>193994</b>	<b>193995</b>			
Function	Double-acting round cylinder					<b>DSNU</b>	DSNU
Piston $\varnothing$ [mm]	32	40	50	63		-...	
Stroke [mm]	1 ... 500				<b>1</b>	-...	
Cushioning	Flexible cushioning rings/pads at both ends					-P	
	Pneumatic cushioning, adjustable at both ends				<b>2</b>	-PPV	
	Pneumatic cushioning, self-adjusting at both ends				<b>3</b>	-PPS	
<b>O</b> Position sensing	Via proximity sensor				<b>4</b>	-A	
Cylinder end cap	Lateral air connection, end cap				<b>5</b>	-MQ	
	Axial air connection, end cap				<b>6</b>	-MA	
	Mounting flange at front (direct mounting), bearing cap				<b>7</b>	-MH	
Type of piston rod	Through piston rod				<b>8</b>	-S2	

- |               |   |             |                            |
|---------------|---|-------------|----------------------------|
| <b>1</b> -... | Longer strokes on request                                       | <b>7</b> MH | Not with combination S6-R3 |
| <b>2</b> PPV  | Not with MA   |             | Not with S10, S11, R8      |
| <b>3</b> PPS  | Not with MA, MH, S6, S10, S11<br>and not with combination MQ-R3 | <b>8</b> S2 | Not with MQ, MA, S10, S11  |
| <b>4</b> A    | Minimum stroke: 10 mm   |             |                            |
| <b>5</b> MQ   | Not with S2, S10, S11   |             |                            |
| <b>6</b> MA   | Not with S2, S10, S11, R8                                       |             |                            |

- Note

The bellows kit DADB must not be used in combination with the variant MH.  
The running characteristics change slightly when the bellows kit DADB is combined with the variant S10 or S11.

**M** Mandatory data

**O** Options

Transfer order code

**DSNU** -  -  -  -  -  -

# Round cylinders DSNU

Ordering data – Modular products

Ordering table							
Size	32	40	50	63	Condi- tions	Code	Enter code
↓ [0] Extended male thread [mm]	Piston rod with extended male thread 1 ... 35			1 ... 70	[9]	-...K2	
Shortened male thread [mm]	Piston rod with shortened male thread 1 ... 8			1 ... 10	[10]	-...K6	
Female thread	(M6)	(M8)	(M10)		[11]	-K3	
Special thread	Piston rod with special thread M10   M12   M16					-“...”K5	
Piston rod extended at one end [mm]	Extended piston rod at one end 1 ... 500					...K8	
Temperature resistance	Heat-resistant seals for temperatures up to 120 °C				[12]	-S6	
Slow speed (constant motion)	Slow speed (constant motion at low piston speeds)				[13]	-S10	
Running characteristics	Low friction				[14]	-S11	
Corrosion protection	High corrosion protection				[15]	-R3	
Wiper seal	Dust protection					-R8	
	Metal wiper seal				[16]	-A6	
EU certification	II 2GD				[17]	-EX4	

- [9] **K2** Not with K3, K6
- [10] **K6** Not with K3
- [11] **K3** Not with K5
- [12] **S6** Not with S10, S11

- [13] **S10** Not with S11, R3, R8
- [14] **S11** Not with R3, R8
- [15] **R3** Not with R8
- [16] **A6** Not with S10, S11, MH, P, PPS, S6, R3, EX4
- [17] **EX4** Not with S6

- [M] Mandatory data
- [O] Options

Transfer order code

- [ ] - [ ] - [ ] - [ ] - [ ] - [ ] - [ ] - [ ] - [ ] - [ ] - [ ] - [ ]

# Round cylinders DSNU-KP, with clamping unit

Technical data

Function  
P cushioning

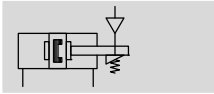

PPV cushioning

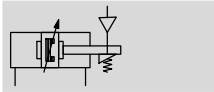

PPS cushioning

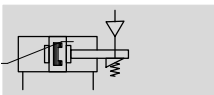

∅ - Diameter  
8 ... 25 mm  
ISO 6432

∅ - Diameter  
32 ... 63 mm

l - Stroke length  
1 ... 500 mm



⚠ - Note

Additional measures are required for use in safety-related applications; in Europe, for example, the standards listed under the EC Machinery Directive must be observed. Without addi-

tional measures in accordance with statutory minimum requirements, the product is not suitable for use in safety-related sections of control systems.

General technical data											
Piston ∅	8	10	12	16	20	25	32	40	50	63	
Conforms	ISO 6432						-				
Pneumatic connection	M5	M5	M5	M5	G <sup>1</sup> / <sub>8</sub>	G <sup>1</sup> / <sub>8</sub>	G <sup>1</sup> / <sub>8</sub>	G <sup>1</sup> / <sub>4</sub>	G <sup>1</sup> / <sub>4</sub>	G <sup>3</sup> / <sub>8</sub>	
Piston rod thread	M4	M4	M6	M6	M8	M10x1.25	M10x1.25	M12x1.25	M16x1.5	M16x1.5	
Stroke <sup>1)</sup> [mm]	1 ... 100		1 ... 200		1 ... 320		1 ... 500				
Constructional design	Piston / Piston rod / Cylinder barrel										
Cushioning											
DSNU-...-P	Flexible cushioning rings/pads at both ends										
DSNU-...-PPV	-		Pneumatic cushioning, adjustable at both ends								
DSNU-...-PPS	-		Self-adjusting cushioning at both ends								
Cushioning length											
DSNU-...-PPV [mm]	-		9	12	15	17	14	18	20	21	
DSNU-...-PPS [mm]	-		12	15	17	14	18	20	21		
Position sensing	Via proximity sensor										
Type of mounting	Via through-holes Via accessories										
Mounting position	Any										
Clamping unit holding force [N]	80	80	180	180	350	350	600	1000	1400	2000	
Axial play under load [mm]	0.2		0.3			0.5			0.8		
Clamping unit pneumatic connection	M5							G <sup>1</sup> / <sub>8</sub>			

1) Cylinders with position sensing require a minimum stroke of 10 mm to ensure reliable sensing. Longer strokes on request.

⚠ - Note: This product conforms to ISO 1179-1 and to ISO 228-1



# Round cylinders DSNU-KP, with clamping unit

Technical data

Operating and environmental conditions	
Operating medium	Compressed air in accordance with ISO 8573-1:2010 [7:4:4]
Note on operating/pilot medium	Operation with lubricated medium possible (in which case lubricated operation will always be required)
Operating pressure [bar]	3 ... 10
Ambient temperature <sup>1)</sup> [°C]	-10 ... +80
Corrosion resistance class CRC <sup>2)</sup>	
DSNU-...-	2
DSNU-...-R3	3

1) Note operating range of proximity sensors.

2) Corrosion resistance class CRC 2 to Festo standard FN 940070

Moderate corrosion stress. Indoor applications in which condensation may occur. External visible parts with primarily decorative requirements for the surface and which are in direct contact with the ambient atmosphere typical for industrial applications.

Corrosion resistance class CRC 3 to Festo standard FN 940070

High corrosion stress. Outdoor exposure under moderate corrosive conditions. External visible parts with primarily functional requirements for the surface and which are in direct contact with a normal industrial environment.

Force [N] and impact energy [J]										
Piston Ø	8	10	12	16	20	25	32	40	50	63
Theoretical force at 6 bar, advancing	30	47	68	121	189	295	483	753	1178	1870
Theoretical force at 6 bar, retracting	23	40	51	104	158	247	415	633	990	1682
Max. impact energy at the end positions for flexible cushioning elements <sup>1)</sup>	0.03	0.05	0.07	0.15	0.20	0.30	0.40	0.70	1	1.30

1) The values are reduced by approx. 50% at an ambient temperature of 80 °C

Weight [g]										
Piston Ø	8	10	12	16	20	25	32	40	50	63
Product weight with 0 mm stroke	97.6	100.3	193	207.9	393.8	456	711.5	1287	2059	2556
Additional weight per 10 mm stroke	2.4	2.7	4	4.6	7.2	11	15.5	24	40	44
Moving load with 0 mm stroke	7.5	8.5	18.5	23	44	71	121	230	413	459
Moving load per 10 mm stroke	1	1	2	2	4	6	9	16	25	25

# Round cylinders DSNU-KP, with clamping unit

Technical data

FESTO

## Average piston speed $v$ as a function of payload $m$ in combination with cushioning PPS

Piston  $\varnothing$  16

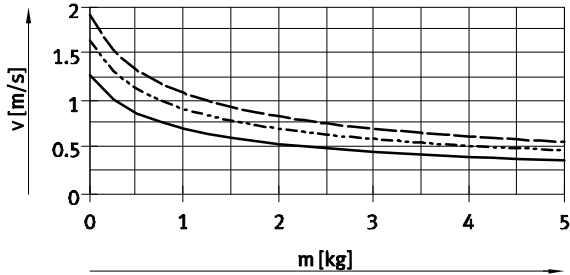

— DSNU-16-50  
 - - - DSNU-16-100  
 - · - DSNU-16-200

Piston  $\varnothing$  20

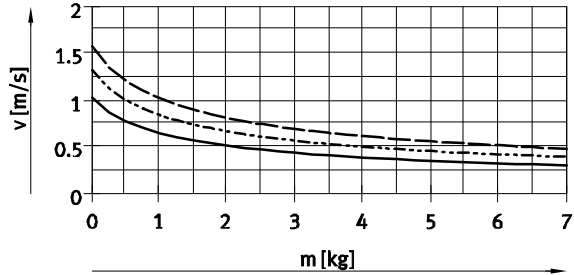

— DSNU-20-50  
 - - - DSNU-20-100  
 - · - DSNU-20-200

Piston  $\varnothing$  25

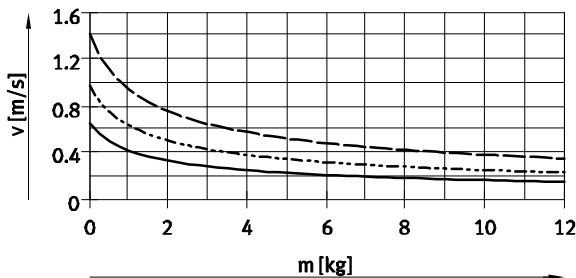

— DSNU-25-50  
 - - - DSNU-25-100  
 - · - DSNU-25-200

Piston  $\varnothing$  32

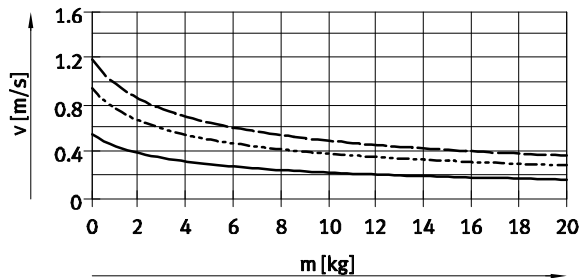

— DSNU-32-50  
 - - - DSNU-32-100  
 - · - DSNU-32-200

Piston  $\varnothing$  40

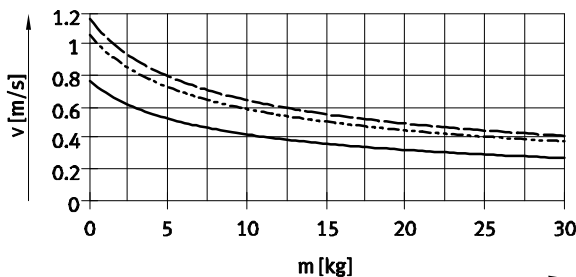

— DSNU-40-50  
 - - - DSNU-40-100  
 - · - DSNU-40-200

Piston  $\varnothing$  50

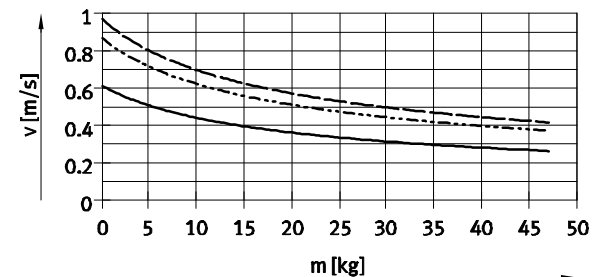

— DSNU-50-50  
 - - - DSNU-50-100  
 - · - DSNU-50-200

Piston  $\varnothing$  63

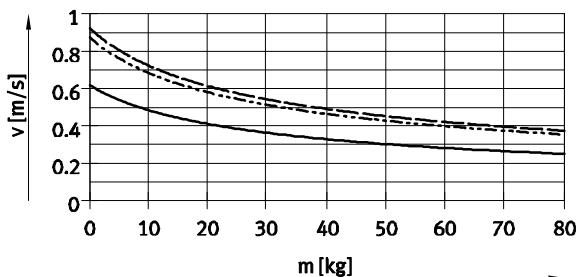

— DSNU-63-50  
 - - - DSNU-63-100  
 - · - DSNU-63-200

- · - Note  
 Design software  
 for flexible cushioning elements  
 PPV cushioning  
 → ProDrive

Additional graphs  
 for PPS cushioning  
 → [www.festo.com](http://www.festo.com)

- · - Note  
 Average piston speed  
 = stroke/movement time

# Round cylinders DSNU-KP, with clamping unit

Technical data

## Max. lateral force $F_q$ as a function of the projection $l$

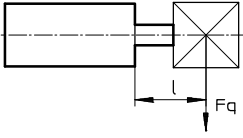

DSNU-...

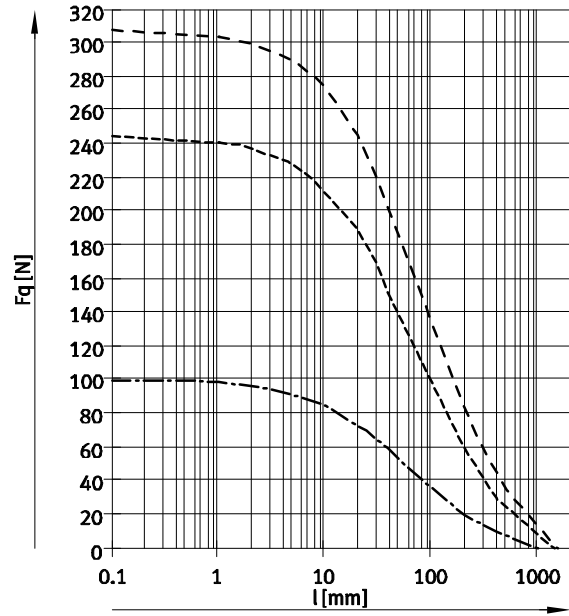
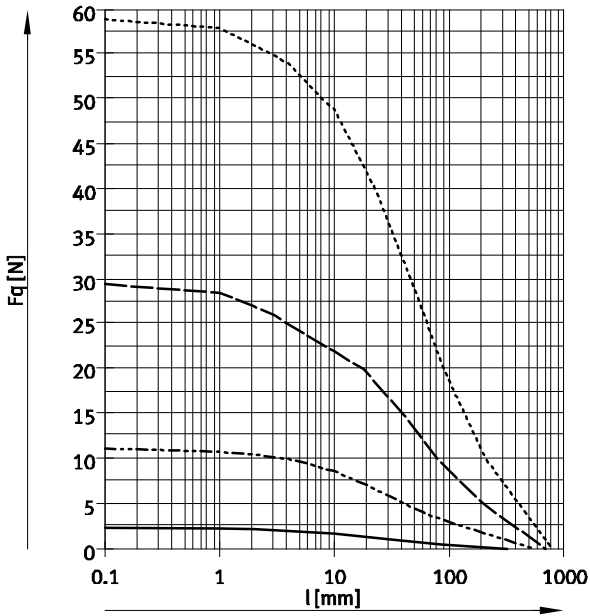

- ∅ 8/10
- - - ∅ 12/16
- ∅ 20
- - - ∅ 25

- - - ∅ 32
- - - ∅ 40
- - - ∅ 50/63

# Round cylinders DSNU-KP, with clamping unit

Technical data

FESTO

## Max. lateral force $F_q$ as a function of the projection $l$

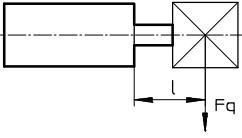

### S2 – Through piston rod

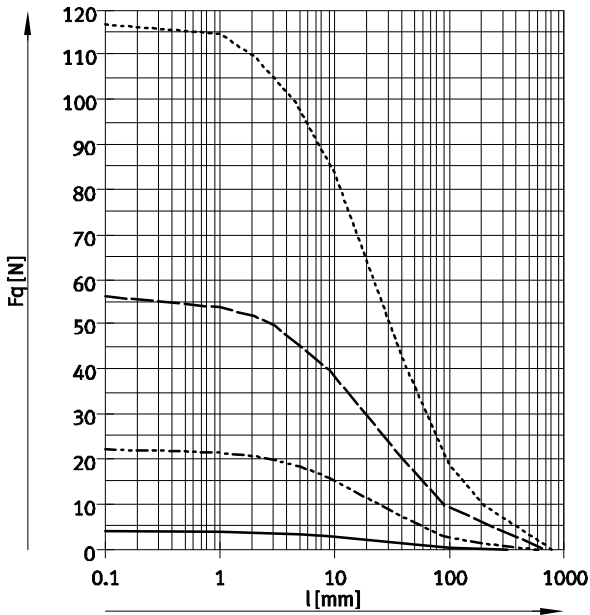

- $\varnothing 8/10$
- - -  $\varnothing 12/16$
- $\varnothing 20$
- - -  $\varnothing 25$

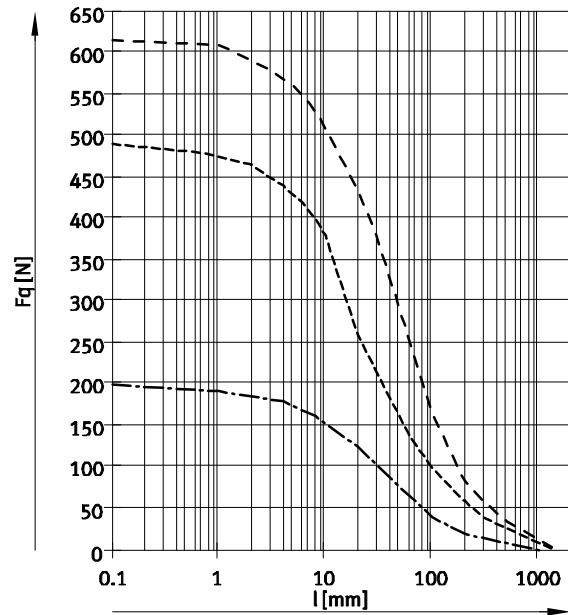

- - -  $\varnothing 32$
- - -  $\varnothing 40$
- - -  $\varnothing 50/63$

# Round cylinders DSNU-KP, with clamping unit

Technical data

## Materials

Sectional view

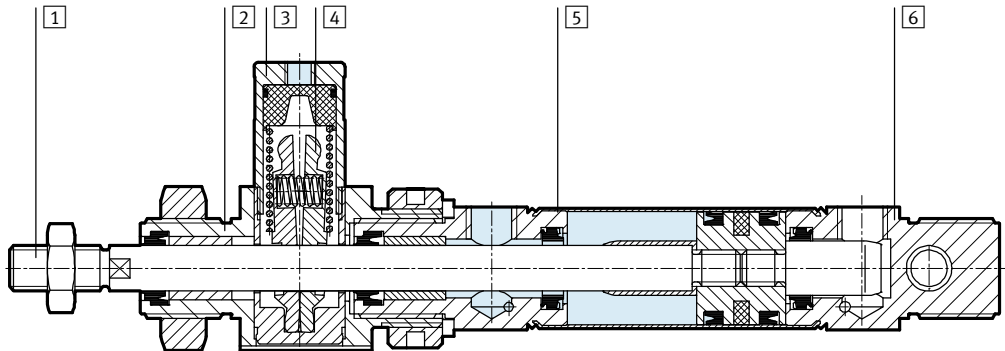

## Round cylinder

1	Piston rod	
	DSNU-...	High-alloy steel
	DSNU-...-R3	High-alloy stainless steel
2	Bearing cap	Anodised aluminium
3	Housing, clamping unit	Wrought aluminium alloy
4	Clamping jaws	Brass
5	Cylinder barrel	High-alloy stainless steel
6	End cap	Anodised aluminium
-	Piston, clamping unit	Polyacetate
-	Spring	Spring steel
-	Seals	TPE-U(PU), NBR
	Note on materials	RoHS compliant

# Round cylinders DSNU-KP, with clamping unit

Technical data

FESTO

## Dimensions

Download CAD data → [www.festo.com](http://www.festo.com)

DSNU-8 ... 25

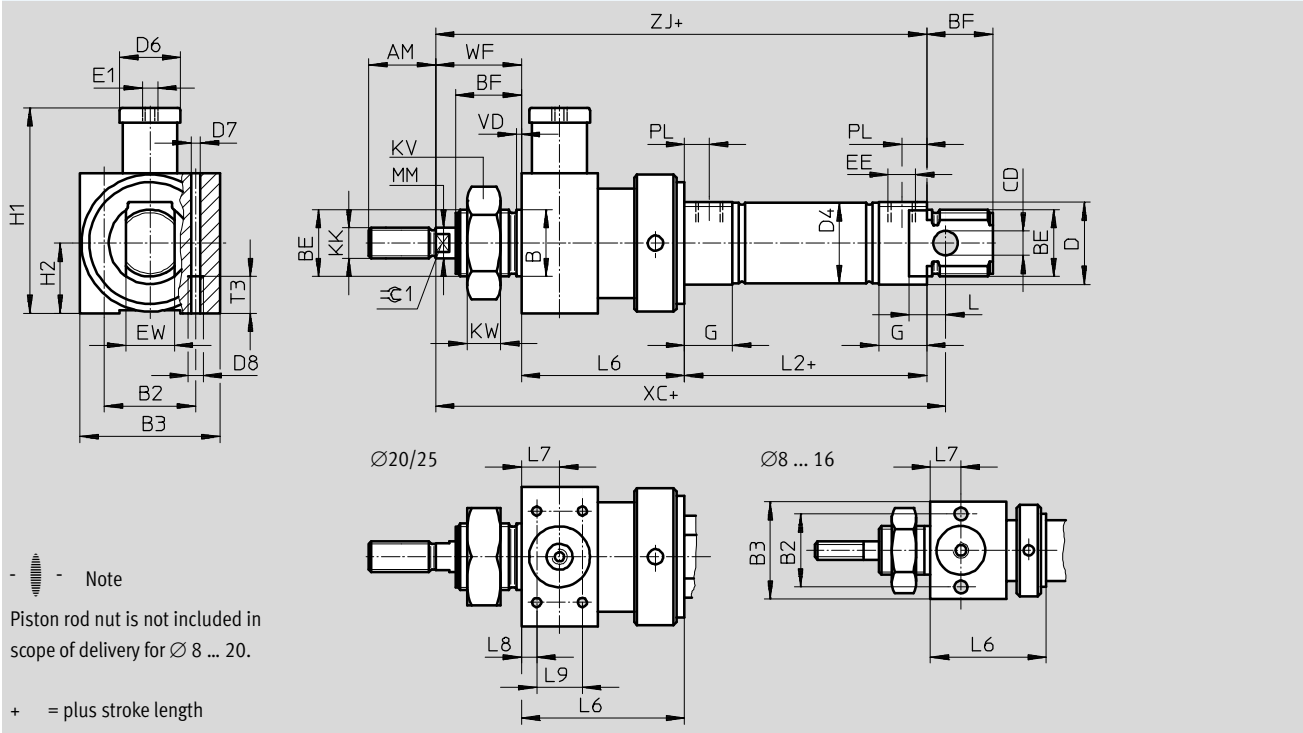

Ø [mm]	AM	B Ø h9	B2	B3	BE	BF	CD Ø H9	D Ø	D4 Ø	D6 Ø	D7 Ø	D8
8	12	12	19.5	27	M12x1.25	12	4	15	9.3	12	4.2	M5
10									11.3			
12	16	16	24	32	M16x1.5	17	6	20	13.3	16	4.2	M5
16									17.3			
20	20	22	27	36	M22x1.5	20	8	27	21.3	20	4.2	M5
25	22					22			26.5			

Ø [mm]	E1	EE	EW	G	H1	H2	KK	KV	KW	MM Ø	L	L2	
8	M5	M5	8	10	34.5	13.5	M4	19	6	4	6	46	
10													
12			12		41	16	M6	24	8	6	9	50	
16		G1/8	16	16	16	62.5	18	M8	32	11	8	12	68
20								10			69.5		
25							M10x1.25			10			

Ø [mm]	L6	L7	L8	L9	T3	PL	VD	WF	XC ±1	≈C1
8	29 ±0.65	8	-	-	11	6	2	16	93	-
10			-	-						-
12	38 ±0.75	10	-	-		6		22	113	5
16			-	-		8.2		24	120	7
20	47 ±0.75	13	4.5	20	8.2	24	142	7		
25	48 ±0.75				28	152	9			

Note: This product conforms to ISO 1179-1 and to ISO 228-1

# Round cylinders DSNU-KP, with clamping unit

Technical data

**Dimensions**

Download CAD data → [www.festo.com](http://www.festo.com)

DSNU-8 ... 25

S2 – Through piston rod

+ = plus stroke length  
 ++ = plus 2x stroke length

- - Note  
 The thread types at both piston rod ends are identical. The clamping unit is mounted on only one side.

In combination with variant Q (→ 54) the right-hand piston rod is square, the left-hand piston rod round. The clamping unit is mounted on the left-hand, round piston rod.

In combination with variant K8 the piston rod is only extended at the right hand. The clamping unit is mounted on the left side of the piston rod that is not extended.

In combination with variant K8 and Q the piston rod is only extended at the right-hand, square piston rod.

∅	ZJ	ZM
[mm]		
8	91	107
10		
12	110	132
16	116	138
20	139	163
25	145.5	173.5

- - Note: This product conforms to ISO 1179-1 and to ISO 228-1

# Round cylinders DSNU-KP, with clamping unit

Technical data

FESTO

## Dimensions

Download CAD data → [www.festo.com](http://www.festo.com)

DSNU-32 ... 63

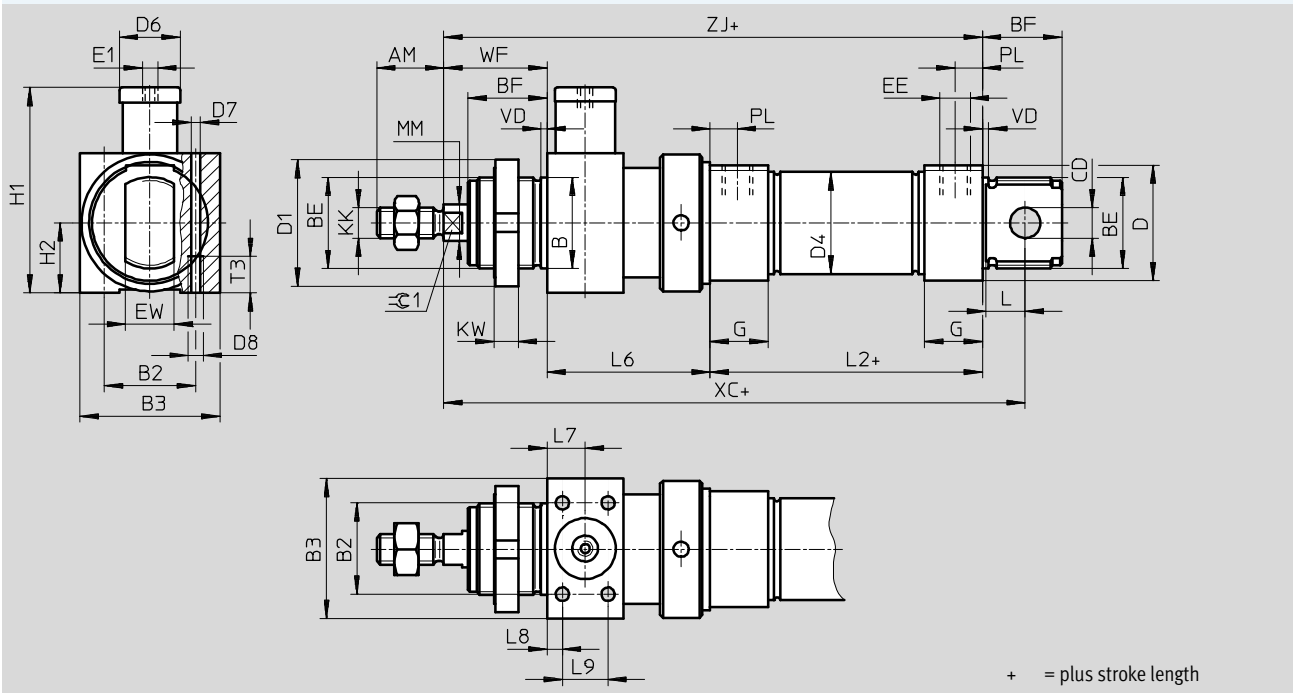

∅ [mm]	AM	B ∅ h9	B2	B3	BE	BF	CD ∅ E10	D ∅	D1 ∅	D4 ∅	D6	D7
32	22	30	30	46	M30x1.5	26	10	38	42	33.6	20	4.4
40	24	38	36	56	M38x1.5	30	12	46	50	41.6	24	6.8
50	32	45	50	65	M45x1.5	33	16	57	60	52.4	30	8.5
63			54	72	M45x1.5			70		65.4	38	

∅ [mm]	D8	E1	EE	EW	G	H1	H2	KK	KW	MM ∅	L	L2
32	M5	M5	G $\frac{1}{8}$	16	19	67.5	23	M10x1.25	8	12	13	69.5
40	M8	G $\frac{1}{8}$	G $\frac{1}{4}$	18	25	89	28	M12x1.25	10	16	15	84.6
50				21		107.5	32.5					
63	M10	G $\frac{1}{8}$	G $\frac{3}{8}$	28	121.5	36	36	94.2				

∅ [mm]	L6	L7	L8	L9	T3	PL	VD	WF	XC	≈C1
	±0.75								±1	
32	55	12.5	5	15	12	9	2	34.5	173	10
40	69	17	7	20	18	12	3	40.5	210.1	13
50	78	20		26	20			45.5	226.7	17
63	86	24	8	32	21	13		46.5	243.7	



# Round cylinders DSNU-KP, with clamping unit

Technical data

**Dimensions**

Download CAD data → [www.festo.com](http://www.festo.com)

DSNU-32 ... 63

S2 – Through piston rod

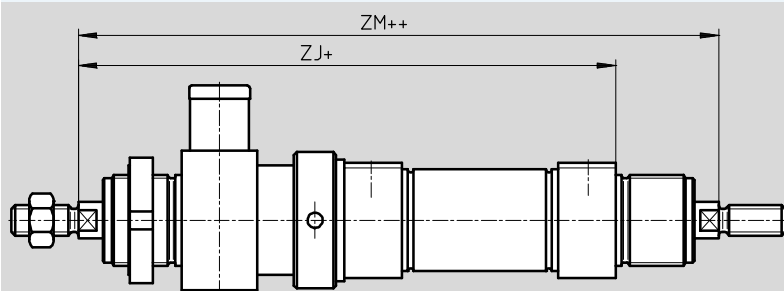

+ = plus stroke length  
++ = plus 2x stroke length

- - Note

The thread types at both piston rod ends are identical. The clamping unit is mounted on only one side.

In combination with variant Q (→ 54) the right-hand piston rod is square, the left-hand piston rod round. The clamping unit is mounted on the left-hand, round piston rod.

In combination with variant K8 the piston rod is only extended at the right hand. The clamping unit is mounted on the left side of the piston rod that is not extended.

In combination with variant K8 and Q the piston rod is only extended at the right-hand, square piston rod.

∅	ZJ	ZM
[mm]		
32	159	191
40	194.1	230.1
50	209.7	250.7
63	226.7	268.7

# Round cylinders DSNU-KP, with clamping unit

Ordering data – Modular products



Ordering table									
Size	8	10	12	16	20	25	Condi- tions	Code	Enter code
<b>M</b> Module No.	<b>193986</b>	<b>193987</b>	<b>193988</b>	<b>193989</b>	<b>193990</b>	<b>193991</b>			
Function	Standard cylinder, double-acting, based on ISO 6432							<b>DSNU</b>	DSNU
Piston Ø [mm]	8	10	12	16	20	25		-...	
Stroke [mm]	1 ... 100		1 ... 200		1 ... 320	1 ... 500	<b>1</b>	-...	
Cushioning	Flexible cushioning rings/pads at both ends								-P
	-		-		Pneumatic cushioning, adjustable at both ends			<b>2</b>	-PPV
	-		-		Pneumatic cushioning, self-adjusting at both ends			<b>3</b>	-PPS
<b>O</b> Position sensing	Via proximity sensor							<b>4</b>	-A
Cylinder end cap	Lateral supply port, end cap							<b>5</b>	-MQ
	Axial supply port, end cap							<b>5</b>	-MA
<b>↓</b> Type of piston rod	Through piston rod								-S2

- 1** -... Longer strokes on request
- 2** **PPV** Not with MA.
- 3** **PPS** Not with MA, MH and not with combination MQ-R3

- 4** **A** Minimum stroke: 10 mm
- 5** **MQ, MA** Not with S2

- M** Mandatory data
- O** Options

Transfer order code

**DSNU** -  -  -  -  -  -

# Round cylinders DSNU-KP, with clamping unit

Ordering data – Modular products

Ordering table									
Size	8	10	12	16	20	25	Condi- tions	Code	Enter code
↓ [O] Extended male thread [mm]	Extended male piston rod thread 1 ... 15		1 ... 20		1 ... 25	1 ... 35	[6]	-...K2	
Shortened male thread [mm]	Shortened male piston rod thread 1 ... 4				1 ... 8	1 ... 10	[7]	-...K6	
Female thread	Female piston rod thread -		-		(M4)	(M6)	[8]	-K3	
Special thread	Piston rod with special thread -		-		-	M10		-“...”K5	
Piston rod extended at one end [mm]	Extended piston rod at one end 1 ... 50		1 ... 100		1 ... 110	1 ... 150		...K8	
Clamping unit	Attached							-KP	-KP

- [6] **K2** Not with K3, K6
- [7] **K6** Not with K3
- [8] **K3** Not with K5

- [M] Mandatory data
- [O] Options

Transfer order code

- [ ] - [ ] - [ ] - [ ] - [ ] - [ ] - KP [ ]

# Round cylinders DSNU-KP, with clamping unit

Ordering data – Modular products



Ordering table							
Size	32	40	50	63	Condi- tions	Code	Enter code
<b>M</b> Module No.	<b>193992</b>	<b>193993</b>	<b>193994</b>	<b>193995</b>			
Function	Double-acting round cylinder					<b>DSNU</b>	DSNU
Piston Ø [mm]	32	40	50	63		-...	
Stroke [mm]	1 ... 500				<b>1</b>	-...	
Cushioning	Flexible cushioning rings/pads at both ends					-P	
	Pneumatic cushioning, adjustable at both ends				<b>2</b>	-PPV	
	Pneumatic cushioning, self-adjusting at both ends				<b>3</b>	-PPS	
<b>O</b> Position sensing	Via proximity sensor				<b>4</b>	-A	
Cylinder end cap	Lateral air connection, end cap				<b>5</b>	-MQ	
	Axial air connection, end cap				<b>5</b>	-MA	
<b>↓</b> Type of piston rod	Through piston rod					-S2	

- 1** -... Longer strokes on request
- 2** **PPV** Not with MA
- 3** **PPS** Not with MA, MH  
and not with combination MQ-R3

- 4** **A** Minimum stroke: 10 mm
- 5** **MQ, MA** Not with S2

- M** Mandatory data
- O** Options

Transfer order code

# Round cylinders DSNU-KP, with clamping unit

Ordering data – Modular products

Ordering table							
Size	32	40	50	63	Condi- tions	Code	Enter code
↓ 0	Extended male thread [mm]	Piston rod with extended male thread 1 ... 35		1 ... 70	6	-...K2	
	Shortened male thread [mm]	Piston rod with shortened male thread 1 ... 8		1 ... 10	7	-...K6	
	Female thread	(M6)	(M8)	(M10)	8	-K3	
	Special thread	Piston rod with special thread M10		M12		-“...”K5	
	Piston rod extended at one end [mm]	Extended piston rod at one end 1 ... 500				...K8	
	Clamping unit	Attached				-KP	-KP

- 6 **K2** Not with K3, K6
- 7 **K6** Not with K3
- 8 **K3** Not with K5

**M** Mandatory data  
**O** Options

Transfer order code

- [ ] - [ ] - [ ] - [ ] - [ ] - KP [ ]

- 1 - Type discontinued  
Available up until 2017



## Round cylinders DSNUP

Technical data

FESTO

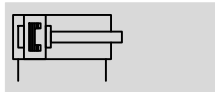
Function  
P cushioning



-  - Diameter  
16 ... 25 mm  
ISO 6432
-  - Stroke length  
25 ... 100 mm



General technical data			
Piston $\varnothing$	16	20	25
Conforms	ISO 6432		
Pneumatic connection	M5	G $\frac{1}{8}$	G $\frac{1}{8}$
Constructional design	Piston / Piston rod / Cylinder barrel		
Stroke [mm]	25 ... 100		
Mode of operation	Double-acting		
Cushioning	Flexible cushioning rings/pads at both ends		
Position sensing	Via proximity sensor		
Type of mounting	Via accessories		
Mounting position	Any		

Operating and environmental conditions	
Operating medium	Compressed air in accordance with ISO 8573-1:2010 [7:4:4]
Note on operating/pilot medium	Operation with lubricated medium possible (in which case lubricated operation will always be required)
Operating pressure <sup>1)</sup> [bar]	1 ... 8
Ambient temperature [°C]	-10 ... +60
Corrosion resistance class CRC <sup>2)</sup>	2

1) Note operating range of proximity sensors

2) Corrosion resistance class CRC 2 to Festo standard FN 940070

Moderate corrosion stress. Indoor applications in which condensation may occur. External visible parts with primarily decorative requirements for the surface and which are in direct contact with the ambient atmosphere typical for industrial applications.

Force [N] and impact energy [J]			
Piston $\varnothing$	16	20	25
Theoretical force at 6 bar, advancing	121	189	295
Theoretical force at 6 bar, retracting	104	158	247
Impact energy at end positions	0.15	0.20	0.30

Weight [g]			
Piston $\varnothing$	16	20	25
Product weight with 0 mm stroke	47	83	111
Additional weight per 10 mm stroke	4	6	8
Moving load at 0 mm stroke	23	44	71
Additional load per 10 mm stroke	2	4	6

- 2 - Type discontinued  
Available up until 2017

FESTO

## Round cylinders DSNUP

Technical data

Speed v without payload				
Piston $\varnothing$		16	20	25
Advancing				
Minimum	[m/s]	0.015	0.02	0.015
Maximum	[m/s]	2.3	2.3	2.3
Retracting				
Minimum	[m/s]	0.015	0.02	0.015
Maximum	[m/s]	1.9	1.7	2.0

### Materials

Sectional view

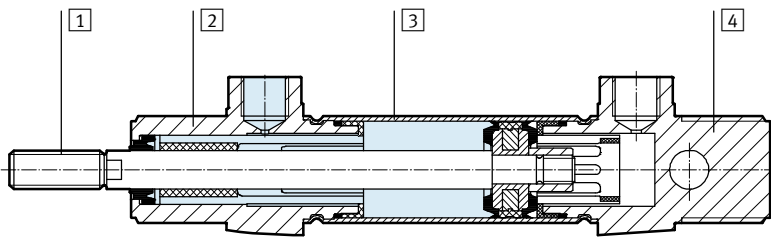

Round cylinder

1	Piston rod	High-alloy stainless steel
2	Bearing cap	Polyamide
3	Cylinder barrel	Wrought aluminium alloy
4	End cap	Polyamide
-	Seals	TPE-U(PU), NBR
Note on materials		RoHS compliant

### Permissible lateral force $F_q$ as a function of stroke length $l$

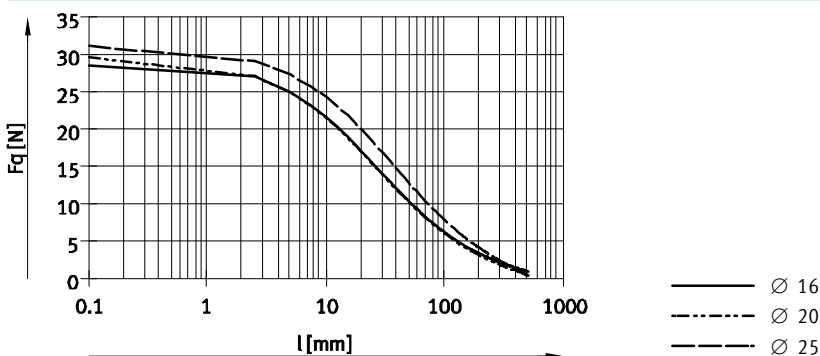

### Permissible piston rod displacement $f$ as a function of stroke length $l$

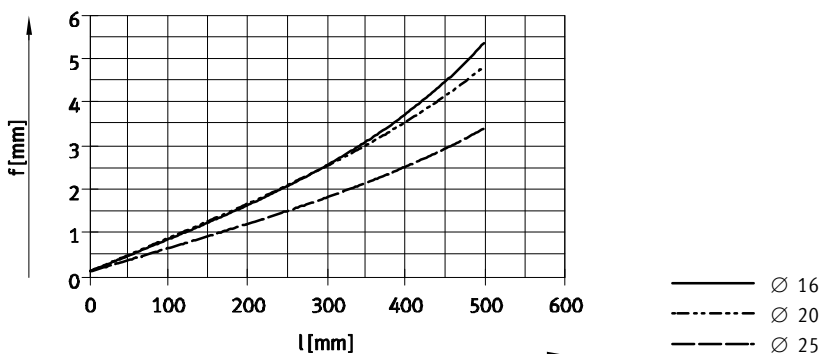

**- 1 - Type discontinued**  
**Available up until 2017**

## Round cylinders DSNUP

Technical data

**FESTO**

### Dimensions

Download CAD data → [www.festo.com](http://www.festo.com)

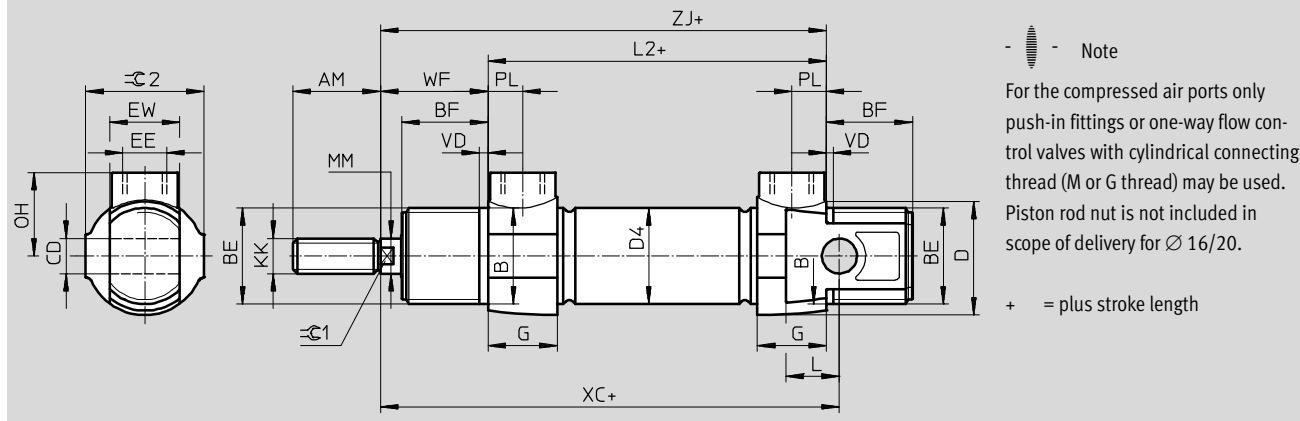

Ø	AM	B Ø	BE	BF	CD Ø	D Ø	D4 Ø	EE
[mm]		h9			H9			
16	16	16	M16x1.5	17	6	20	18	M5
20	20	22	M22x1.5	20	8	27	22	G <sup>1</sup> / <sub>8</sub>
25	22	22	M22x1.5	22	8	27	27	G <sup>1</sup> / <sub>8</sub>

Ø	EW	G	KK	L	L2	MM Ø	OH	PL	VD
[mm]									
16	12	10	M6	8	56	6	14	4.9	2
20	16	16	M8	12	68	8	19	7.9	2
25	16	16	M10x1.25	12	70	10	19	7.9	2

Ø	WF	XC ±1	ZJ	≈C 1	≈C 2	Max. tightening torque of thread [Nm]	
						BE <sup>1)</sup>	EE
[mm]							
16	22	82	78	5	19	12/8	1.3
20	24	95	92	7	27	22/15	6
25	28	104	98	9	27	22/15	6

1) Bearing cap/end cap



- 2 - Type discontinued  
Available up until 2017

FESTO

## Round cylinders DSNUP

Technical data

-  - Note

Variable strokes on request.

Ordering data			
Piston $\varnothing$ [mm]	Stroke [mm]	Part No.	Type
16	25	551668	DSNUP-16-25-P-A
	50	551669	DSNUP-16-50-P-A
	100	551670	DSNUP-16-100-P-A
20	25	551671	DSNUP-20-25-P-A
	50	551672	DSNUP-20-50-P-A
	100	551673	DSNUP-20-100-P-A
25	25	551674	DSNUP-25-25-P-A
	50	551675	DSNUP-25-50-P-A
	100	551676	DSNUP-25-100-P-A

# Round cylinders DSNU-Q, protected against rotation

FESTO

Technical data

Function

P cushioning

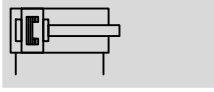

PPV cushioning

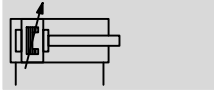

⌀ - Diameter  
12 ... 25 mm  
ISO 6432

⌀ - Diameter  
32 ... 63 mm

┆ - Stroke length  
5 ... 500 mm

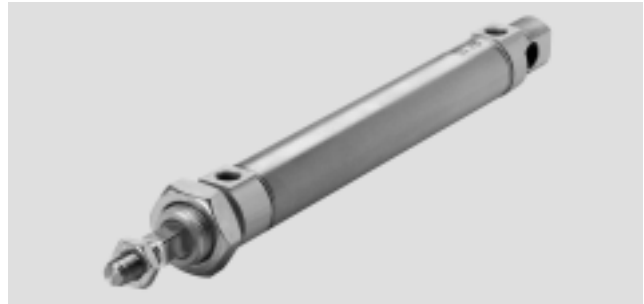

General technical data								
Piston ⌀	12	16	20	25	32	40	50	63
Conforms	ISO 6432				-			
Pneumatic connection	M5	M5	G $\frac{1}{8}$	G $\frac{1}{8}$	G $\frac{1}{8}$	G $\frac{1}{4}$	G $\frac{1}{4}$	G $\frac{3}{8}$
Piston rod thread	M6	M6	M8	M10x1.25	M10x1.25	M12x1.25	M16x1.5	M16x1.5
Stroke <sup>1)</sup> [mm]	5 ... 160		5 ... 200	5 ... 250	5 ... 300	5 ... 400		5 ... 500
Constructional design	Piston Protected against rotation with square piston rod							
Max. torque at the piston rod [Nm]	0.10	0.10	0.20	0.45	0.8	1.1	0.45	0.45
Cushioning								
DSNU-...-P	Flexible cushioning rings/pads at both ends	-			Flexible cushioning rings/pads at both ends			
DSNU-...-PPV	-	Adjustable cushioning at both ends						
Cushioning length (PPV) [mm]	-	12	15	17	14	18	20	21
Position sensing	Via proximity sensor							
Type of mounting	Via accessories							
Mounting position	Any							

1) Cylinders with position sensing require a minimum stroke of 10 mm to ensure reliable sensing. Longer strokes on request.

⌚ Note: This product conforms to ISO 1179-1 and to ISO 228-1

Operating and environmental conditions								
Piston ⌀	12	16	20	25	32	40	50	63
Operating medium	Compressed air in accordance with ISO 8573-1:2010 [7:4:4]							
Note on operating/pilot medium	Operation with lubricated medium possible (in which case lubricated operation will always be required)							
Operating pressure [bar]	1.5 ... 10 <sup>1)</sup>		1 ... 10					
Ambient temperature <sup>2)</sup>								
DSNU-... [°C]	-20 ... +80							
DSNU-Q-...-S6 [°C]	-				0 ... +120			
Corrosion resistance class CRC <sup>3)</sup>								
DSNU-...	2							
DSNU-...-R3	3							
Certification	Germanischer Lloyd				-			

1) With DSNU-12-...-Q-PPV (pneumatic cushioning adjustable at both ends): 2 ... 10 bar

2) Note operating range of proximity sensors.

3) Corrosion resistance class CRC 2 to Festo standard FN 940070

Moderate corrosion stress. Indoor applications in which condensation may occur. External visible parts with primarily decorative requirements for the surface and which are in direct contact with the ambient atmosphere typical for industrial applications.

Corrosion resistance class CRC 3 to Festo standard FN 940070

High corrosion stress. Outdoor exposure under moderate corrosive conditions. External visible parts with primarily functional requirements for the surface and which are in direct contact with a normal industrial environment.

# Round cylinders DSNU-Q, protected against rotation

Technical data

ATEX <sup>1)</sup>	
ATEX category for gas	II 2G
Explosion ignition protection type for gas	c T4
ATEX category for dust	II 2D
Explosion ignition protection type for dust	c 120°C
Explosion-proof temperature rating	-20°C ≤ Ta ≤ +60°C
CE marking (see declaration of conformity)	To EU Explosion Protection Directive (ATEX)

1) Make sure that the accessories are suited for ATEX application.

Forces [N] and impact energy [J]								
Piston Ø	12	16	20	25	32	40	50	63
Theoretical force at 6 bar, advancing	68	121	189	295	483	753	1178	1870
Theoretical force at 6 bar, retracting	51	104	158	247	415	633	990	1682
Max. impact energy at the end positions for flexible cushioning elements <sup>1)</sup>	0.07	0.15	0.20	0.30	0.40	0.70	1	1.3

1) The values are reduced by approx. 50% at an ambient temperature of 80 °C

Weight [g]								
Piston Ø	12	16	20	25	32	40	50	63
Product weight with 0 mm stroke	80	110	215	275	370.5	661	1087	1445
Additional weight per 10 mm stroke	4.1	4.7	7.1	10.9	15.5	24	40	44
Moving load with 0 mm stroke	18.5	23	44	71	121	230	413	459
Moving load per 10 mm stroke	2	2	4	6	9	16	25	25

## Materials

Sectional view

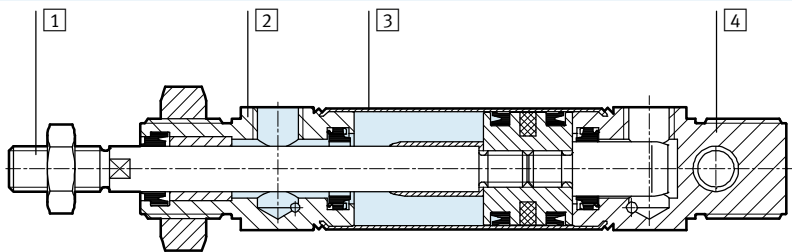

Round cylinder	
1	Piston rod
	DSNU-...
	DSNU-...-R3
	High-alloy steel
	High-alloy stainless steel
2	Bearing cap
3	Cylinder barrel
4	End cap
-	Seals
	TPE-U(PU), NBR
	Note on materials
	RoHS compliant

# Round cylinders DSNU-Q, protected against rotation

Technical data

FESTO

## Dimensions

Download CAD data → [www.festo.com](http://www.festo.com)

DSNU-12 ... 25

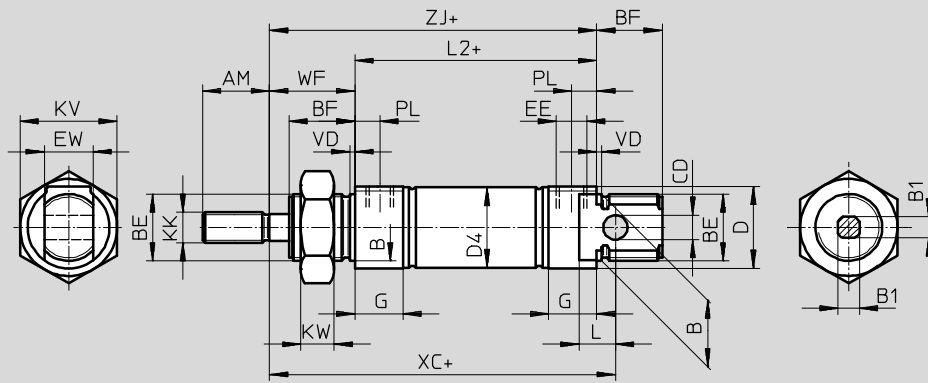

Note  
Piston rod nut is not included in scope of delivery for  $\varnothing$  12 ... 20.  
+ = plus stroke length

$\varnothing$	AM	B	B1	BE	BF	CD	D	D4	EE	EW
[mm]		$\varnothing$ h9	□			$\varnothing$ H9	$\varnothing$	$\varnothing$		
12	16	16	5.5	M16x1.5	17	6	20	13.3	M5	12
16								17.3		
20	22	22	7	M22x1.5	20	8	27	21.3	G1/8	16
25			9		22			26.5		

$\varnothing$	G	KK	KV	KW	L	L2	PL	VD	WF	XC	ZJ
[mm]										$\pm 1$	
12	10	M6	24	8	9	50	6	2	22	75	72
16						56				82	78
20	16	M8	32	11	12	68	8.2		24	95	92
25		M10x1.25				69.5	28		104	97.5	

Note: This product conforms to ISO 1179-1 and to ISO 228-1

## S2 – Through piston rod

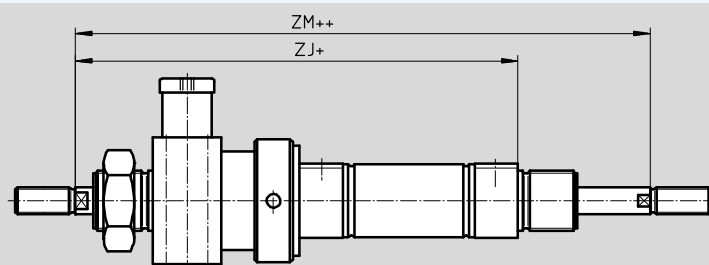

Note

The thread types at both piston rod ends are identical. The clamping unit is mounted on only one side. In

combination with variant Q, the right-hand piston rod is square, the left-hand piston rod round.

The clamping unit is mounted on the left-hand, round piston rod.

+ = plus stroke length  
++ = plus 2x stroke length

$\varnothing$	ZJ	ZM
[mm]		
12	110	132
16	116	138
20	139	163
25	145.5	173.5

# Round cylinders DSNU-Q, protected against rotation

Technical data

Dimensions Download CAD data → [www.festo.com](http://www.festo.com)  
 DSNU-32 ... 63

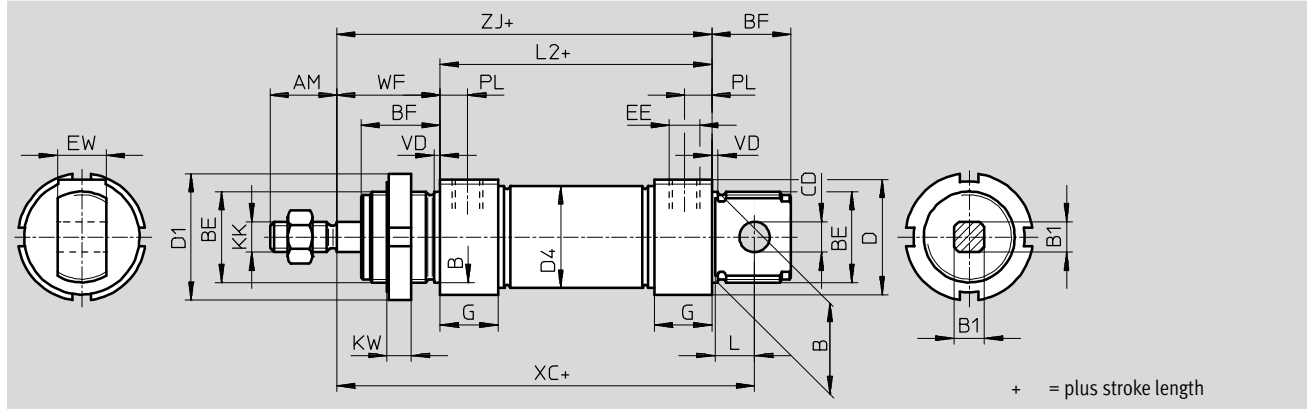

∅	AM	B	B1	BE	BF	CD	D	D1	D4	EE	EW
[mm]		∅ h9	□			∅ E10	∅	∅	∅		
32	22	30	10	M30x1.5	26	10	38	42	33.6	G <sup>1</sup> / <sub>8</sub>	16
40	24	38	12	M38x1.5	30	12	46	50	41.6	G <sup>1</sup> / <sub>4</sub>	18
50	32	45	16	M45x1.5	33	16	57	60	52.4	G <sup>1</sup> / <sub>4</sub>	21
63	32	45	16	M45x1.5	33	16	70	60	65.4	G <sup>3</sup> / <sub>8</sub>	21

∅	G	KK	KW	L	L2	PL	VD	WF	XC	ZJ
[mm]									±1	
32	19	M10x1.25	8	13	69.5	9	2	34	117.5	103.5
40	25	M12x1.25	10	15	84.6	12	3	39	139.6	123.6
50	25	M16x1.5	10	16	86.2	12	3	44	147.2	130.2
63	28	M16x1.5	10	16	94.2	13	3	45	156.2	139.2

## S2 – Through piston rod

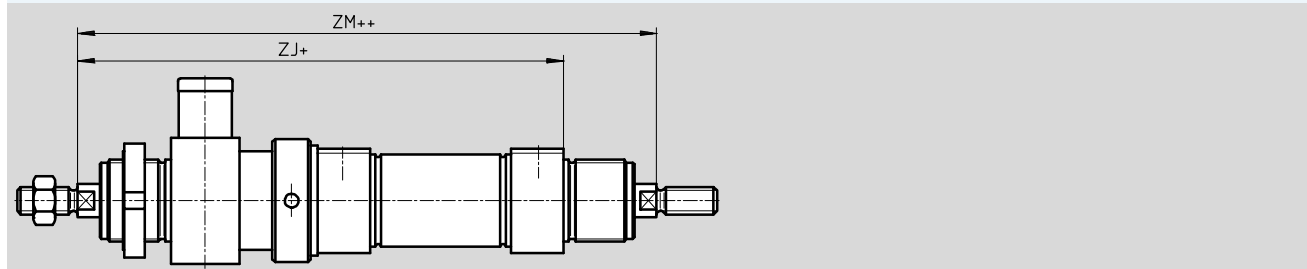

Note

The thread types at both piston rod ends are identical. The clamping unit is mounted on only one side. In combination with variant Q, the right-hand piston rod is square, the left-hand piston rod round.

The clamping unit is mounted on the left-hand, round piston rod.

+ = plus stroke length  
 ++ = plus 2x stroke length

∅	ZJ	ZM
[mm]		
32	159	191
40	194.1	230.1
50	209.7	250.7
63	226.7	268.7

# Round cylinders DSNU-Q, protected against rotation

Ordering data – Modular products

Ordering table							
Size	12	16	20	25	Condi- tions	Code	Enter code
<b>M</b> Module No.	<b>193988</b>	<b>193989</b>	<b>193990</b>	<b>193991</b>			
Function	Standard cylinder, double-acting, based on ISO 6432					<b>DSNU</b>	DSNU
Piston Ø [mm]	12	16	20	25		-...	
Stroke [mm]	5 ... 160		5 ... 200	5 ... 250	<b>1</b>	-...	
Cushioning	Flexible cushion- ing rings/pads at both ends	-	-	-		-P	
	-	Pneumatic cushioning, adjustable at both ends			<b>2</b>	-PPV	
<b>O</b> Position sensing	Via proximity sensor				<b>3</b>	-A	
Cylinder end cap	Lateral supply port, end cap				<b>4</b>	-MQ	
	Axial supply port, end cap	-	-	-	<b>4</b>	-MA	
	-	With mounting flange at front (direct mounting), bearing cap			<b>5</b>	-MH	
Protection against rotation	Square piston rod					-Q	-Q
<b>↓</b> Type of piston rod	Through piston rod					-S2	

- 1** -... Longer strokes on request
- 2** **PPV** Not with MA
- 3** **A** Minimum stroke: 10 mm

- 4** **MQ, MA** Not with S2
- 5** **MH** Not with combination Q-R3

 Note

The bellows kit DADB must not be used in combination with the variant Q.

- M** Mandatory data
- O** Options

Transfer order code

**DSNU** -  -  -  -  -  -  - **Q** -

# Round cylinders DSNU-Q, protected against rotation

Ordering data – Modular products

Ordering table							
Size	12	16	20	25	Condi- tions	Code	Enter code
↓ [O] Extended male thread [mm]	Extended male piston rod thread 1 ... 20			1 ... 25	1 ... 35	[6]	-...K2
Shortened male thread [mm]	Shortened male piston rod thread 1 ... 4			1 ... 8	1 ... 10	[7]	-...K6
Female thread	Female piston rod thread - - (M4)			(M6)	[8]	-K3	
Special thread	Piston rod with special thread - - -			M10		-“...”K5	
Piston rod extended at one end [mm]	Extended piston rod at one end 1 ... 100			1 ... 110	1 ... 150		...K8
Clamping unit	Attached				[9]	-KP	
Corrosion protection	- High corrosion protection					-R3	
EU certification	II 2GD				[10]	-EX4	

- [6] **K2** Not with K3, K6
- [7] **K6** Not with K3
- [8] **K3** Not with K5

- [9] **KP** Only with S2.  
Not with R3
- [10] **EX4** Not with KP

[M] Mandatory data  
[O] Options

**Transfer order code**

- [ ] - [ ] - [ ] - [ ] - [ ] - [ ] - [ ] - [ ]

# Round cylinders DSNU-Q, protected against rotation

Ordering data – Modular products



Ordering table							
Size	32	40	50	63	Condi- tions	Code	Enter code
<b>M</b> Module No.	<b>193992</b>	<b>193993</b>	<b>193994</b>	<b>193995</b>			
Function	Double-acting round cylinder					<b>DSNU</b>	DSNU
Piston Ø [mm]	32	40	50	63		-...	
Stroke [mm]	5 ... 300	5 ... 400		5 ... 500	<b>1</b>	-...	
Cushioning	Flexible cushioning rings/pads at both ends					<b>-P</b>	
	Pneumatic cushioning, adjustable at both ends				<b>2</b>	<b>-PPV</b>	
<b>O</b> Position sensing	Via proximity sensor				<b>3</b>	<b>-A</b>	
Cylinder end cap	Lateral air connection, end cap				<b>4</b>	<b>-MQ</b>	
	Axial air connection, end cap				<b>4</b>	<b>-MA</b>	
	Mounting flange at front (direct mounting), bearing cap				<b>5</b>	<b>-MH</b>	
Protection against rotation	Square piston rod					<b>-Q</b>	-Q
<b>↓</b> Type of piston rod	Through piston rod					<b>-S2</b>	

- 1** -... Longer strokes on request
- 2** **PPV** Not with MA
- 3** **A** Minimum stroke: 10 mm

- 4** **MQ, MA** Not with S2
- 5** **MH** Not with combinations: Q-R3, S6-R3  
Not with KP

- Note

The bellows kit DADB must not be used in combination with the variant Q.

**M** Mandatory data

**O** Options

Transfer order code

**DSNU** -  -  -  -  -  -  - **Q** -



# Round cylinders DSNU-Q, protected against rotation

Ordering data – Modular products

Ordering table							
Size	32	40	50	63	Condi- tions	Code	Enter code
↓ 0	Extended male thread [mm]	Piston rod with extended male thread 1 ... 35		1 ... 70	6	-...K2	
	Shortened male thread [mm]	Piston rod with shortened male thread 1 ... 8		1 ... 10	7	-...K6	
	Female thread	(M6)	(M8)	(M10)	8	-K3	
	Special thread	Piston rod with special thread M10		M12	M16	-“...”K5	
	Piston rod extended at one end [mm]	Extended piston rod at one end 1 ... 500				...K8	
	Clamping unit	Attached			9	-KP	
	Temperature resistance	Heat-resistant seals for temperatures up to 120 °C				-S6	
	Corrosion protection	High corrosion protection				-R3	
	EU certification	II 2GD			10	-EX4	

- 6 **K2** Not with K3, K6
- 7 **K6** Not with K3
- 8 **K3** Not with K5

- 9 **KP** Only with S2  
Not with S6, R3
- 10 **EX4** Not with KP

**M** Mandatory data  
**O** Options

**Transfer order code**

- [ ] - [ ] - [ ] - [ ] - [ ] - [ ] - [ ] - [ ] - [ ]



# Round cylinders ESNU

Technical data

FESTO

Function  
Flexible cushioning



-  Diameter  
8 ... 25 mm  
IO 6432
-  Diameter  
32 ... 63 mm
-  Stroke length  
1 ... 50 mm



General technical data											
Piston Ø	8	10	12	16	20	25	32	40	50	63	
Conforms	ISO 6432						-				
Pneumatic connection	M5	M5	M5	M5	G1/8	G1/8	G1/8	G1/4	G1/4	G3/8	
Piston rod thread	M4	M4	M6	M6	M8	M10x1.25	M10x1.25	M12x1.25	M16x1.5	M16x1.5	
Stroke <sup>1)</sup>	[mm] 1 ... 50										
Constructional design	Piston / Piston rod / Cylinder barrel										
Cushioning	Flexible cushioning rings/pads at both ends										
Position sensing	Via proximity sensor										
Type of mounting	Via accessories										
Mounting position	Any										

1) Cylinders with position sensing require a minimum stroke of 10 mm to ensure reliable sensing

-  Note: This product conforms to ISO 1179-1 and to ISO 228-1

Operating and environmental conditions											
Piston Ø	8	10	12	16	20	25	32	40	50	63	
Operating medium	Compressed air in accordance with ISO 8573-1:2010 [7:4:4]										
Note on operating/pilot medium	Operation with lubricated medium possible (in which case lubricated operation will always be required)										
Operating pressure	[bar] 1.5 ... 10			1.2 ... 10							
Ambient temperature <sup>1)</sup>	[°C] -20 ... +80										
Corrosion resistance class CRC <sup>2)</sup>	2										

1) Note operating range of proximity sensors.

2) Corrosion resistance class CRC 2 to Festo standard FN 940070

Moderate corrosion stress. Indoor applications in which condensation may occur. External visible parts with primarily decorative requirements for the surface and which are in direct contact with the ambient atmosphere typical for industrial applications.

# Round cylinders ESNU

Technical data

FESTO

Force [N] and impact energy [J]										
Piston Ø	8	10	12	16	20	25	32	40	50	63
Theoretical force at 6 bar, advancing	24	41	61	107	169	270	442	688	1071	1763
Spring return force										
10 mm stroke	4.9	4.9	6.3	13.2	18.3	22.9	36	60	95	95
25 mm stroke	4.1	4.1	5.4	11.9	16.5	21.2	30	50	82	82
50 mm stroke	2.8	4.8	3.9	9.8	13.6	18.5	20	30	60	60
Max. impact energy at the end positions <sup>1)</sup>	0.03	0.05	0.07	0.15	0.20	0.30	0.40	0.70	1	1.3

1) The values are reduced by approx. 50% at ambient temperatures of 80 °C

Weight ESNU-... [g]										
Piston Ø	8	10	12	16	20	25	32	40	50	63
Product weight with 0 mm stroke	35	37.3	75	89.9	186.8	238	370.5	661	1087	1445
Additional weight per 10 mm stroke	2.4	2.7	4	4.6	7.2	11	15.5	24	40	44

Weight ESNU-...-MA [g]										
Piston Ø	8	10	12	16	20	25	32	40	50	63
Product weight with 0 mm stroke	30	33	65	81	167	222	330	585	1013	1369
Additional weight per 10 mm stroke	2.4	2.7	4	4.6	7.2	11	15.5	24	40	44

## Materials

Sectional view

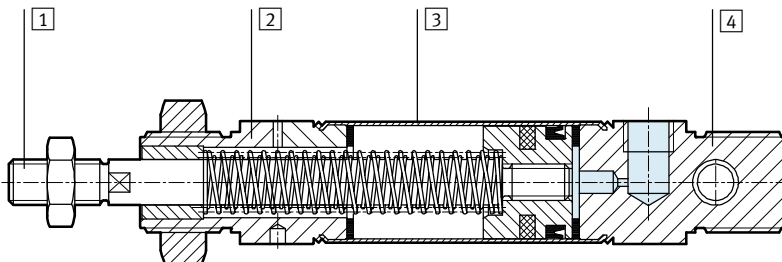

Round cylinder	
1	Piston rod High-alloy steel
2	Bearing cap Anodised aluminium
3	Cylinder barrel High-alloy stainless steel
4	End cap Anodised aluminium
-	Seals TPE-U(PU), NBR
-	Spring Spring steel
Note on materials RoHS compliant	

# Round cylinders ESNU

Technical data

FESTO

## Dimensions

ESNU-8 ... 25

Download CAD data → [www.festo.com](http://www.festo.com)

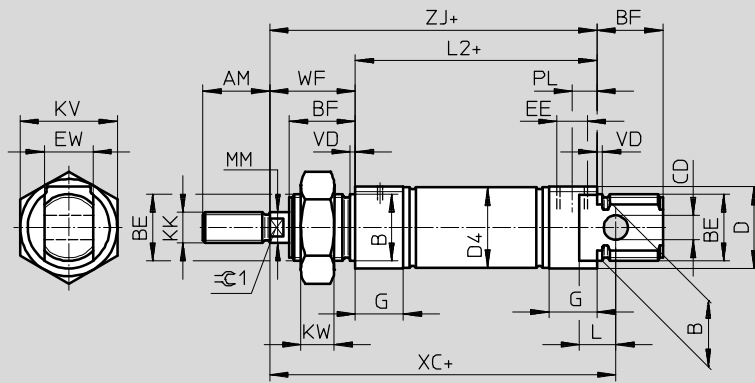

Note  
Piston rod nut is not included in scope of delivery for Ø 8 ... 20.  
+ = plus stroke length

## MA – Axial air connection

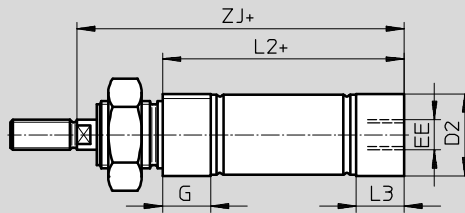

+ = plus stroke length

Ø	AM	B	BE	BF	CD	D	D2	D4	EE	EW	G	KK	KV
[mm]		Ø h9			Ø H9	Ø	Ø	Ø					
8	12	12	M12x1.25	12	4	15	10.5	9.3	M5	8	10	M4	19
10							12.5	11.3					
12	16	16	M16x1.5	17	6	20	14.5	13.3		12	M6	24	
16							17.5	17.3					
20	22	22	M22x1.5	20	8	27	21.7	21.3	G <sup>1</sup> / <sub>8</sub>	16	16	M8	32
25				22			22	26.7					

Ø [mm]	KW	L	L2		L3	MM Ø	PL	VD	WF	XC ±1	ZJ		≈C1	
			ESNU- ...	-MA							ESNU- ...	-MA		
8	6	6	46	43.6	7.6	4	6	2	16	64	62	59.6	-	
10				43.1								7.1		59.1
12	8	9	50	47.7	7.7	6			22	75	72	78	69.7	5
16				56									53.7	
20	11	12	68	66.5	14.5	8	8.2	24	95	92	90.5	90.5	7	
25				69.5								68.5		14

Note: This product conforms to ISO 1179-1 and to ISO 228-1

# Round cylinders ESNU

Technical data

FESTO

## Dimensions

Download CAD data → [www.festo.com](http://www.festo.com)

ESNU-8 ... 25

K2 – Extended male piston rod thread

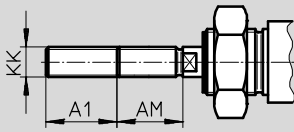

K6 – Shortened male piston rod thread

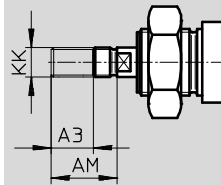

K3 – Female piston rod thread

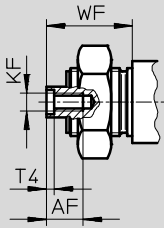

K5 – Special piston rod thread

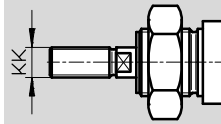

K8 – Extended piston rod

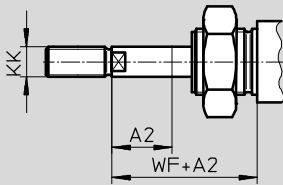

∅ [mm]	A1 max.	A2 max.	A3 max.	AF	AM	KF	KK		T4	WF
							Basic thread	Special thread <sup>1)</sup>		
8	15	50	4	–	12	–	M4	–	–	16
10				–		–		–		
12				–		–	–			
16	20			–	–	16	–	M6	–	–
20			25						20	M4
25	35		8	12	22	M6	M10x1.25	M10	2.6	28

1) The special threads are only available as male threads. The scope of delivery does not include a hex nut for the piston rod thread.

# Round cylinders ESNU

Technical data



## Dimensions

Download CAD data → [www.festo.com](http://www.festo.com)

ESNU-32 ... 63

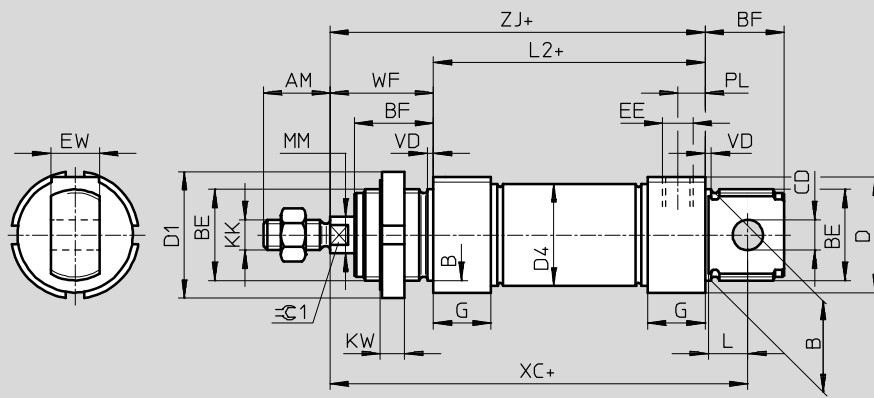

+ = plus stroke length

## MA – Axial air connection

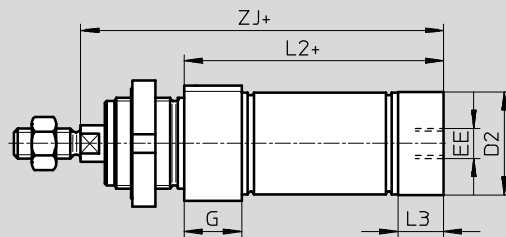

+ = plus stroke length

∅	AM	B	BE	BF	CD	D	D1	D2	D4	EE	EW	G	KK
[mm]		∅ h9			∅ E10	∅	∅	∅	∅				
32	22	30	M30x1.5	26	10	38	42	34	33.6	G $\frac{1}{8}$	16	19	M10x1.25
40	24	38	M38x1.5	30	12	46	50	42	41.6	G $\frac{1}{4}$	18	25	M12x1.25
50	32	45	M45x1.5	33	16	57	60	53	52.4		G $\frac{3}{8}$		21
63						70	66	65.4					

∅	KW	L	L2		L3	PL	MM	VD	WF	XC	ZJ		≈C1
			ESNU- ...	-MA							ESNU- ...	-MA	
[mm]							∅			±1			
32	8	13	69.5	65.5	15	9	12	2	34	117.5	103.5	99.5	10
40	10	15	84.6	77.6	18	12	16	3	39	139.6	123.6	116.6	13
50		16	86.2	86.2	25		20		44	147.2	130.2	130.2	17
63		94.2	94.2	28	13	45	156.2		139.2	139.2			

# Round cylinders ESNU

Technical data

## Dimensions

Download CAD data → [www.festo.com](http://www.festo.com)

ESNU-32 ... 63

K2 – Extended male piston rod thread

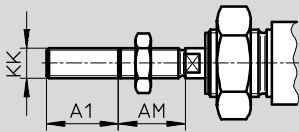

K6 – Shortened male piston rod thread

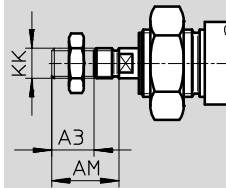

K3 – Female piston rod thread

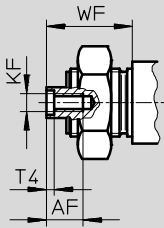

K5 – Special piston rod thread

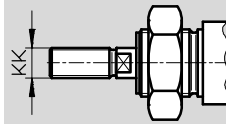

K8 – Extended piston rod

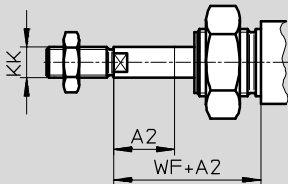

Ø [mm]	A1 max.	A2 max.	A3 max.	AF	AM	KF	KK		T4	WF
							Basic thread	Special thread <sup>1)</sup>		
32	35	50	8	12	22	M6	M10x1.25	M10	2.6	34
40					24	M8	M12x1.25	M12	3.3	39
50			10	16	32	M10	M16x1.5	M16	4.7	44
63										45

1) The special threads are only available as male threads. The scope of delivery does not include a hex nut for the piston rod thread.

# Round cylinders ESNU

Technical data

FESTO

Ordering data					
Piston $\varnothing$ [mm]	Stroke [mm]	Without position sensing		A – With position sensing	
		Part No.	Type	Part No.	Type
8	10	-		19254	ESNU-8-10-P-A
	25	-		19255	ESNU-8-25-P-A
	50	-		19256	ESNU-8-50-P-A
10	10	-		19257	ESNU-10-10-P-A
	25	-		19258	ESNU-10-25-P-A
	50	-		19259	ESNU-10-50-P-A
12	10	-		19260	ESNU-12-10-P-A
	25	-		19261	ESNU-12-25-P-A
	50	-		19262	ESNU-12-50-P-A
16	10	-		19263	ESNU-16-10-P-A
	25	-		19264	ESNU-16-25-P-A
	50	-		19265	ESNU-16-50-P-A
20	10	-		19266	ESNU-20-10-P-A
	25	-		19267	ESNU-20-25-P-A
	50	-		19268	ESNU-20-50-P-A
25	10	-		19269	ESNU-25-10-P-A
	25	-		19270	ESNU-25-25-P-A
	50	-		19271	ESNU-25-50-P-A
32	10	195870	ESNU-32-10-P	196376	ESNU-32-10-P-A
	25	195871	ESNU-32-25-P	196377	ESNU-32-25-P-A
	50	195872	ESNU-32-50-P	196378	ESNU-32-50-P-A
40	10	195873	ESNU-40-10-P	196379	ESNU-40-10-P-A
	25	195874	ESNU-40-25-P	196380	ESNU-40-25-P-A
	50	195875	ESNU-40-50-P	196381	ESNU-40-50-P-A
50	10	195876	ESNU-50-10-P	196382	ESNU-50-10-P-A
	25	195877	ESNU-50-25-P	196383	ESNU-50-25-P-A
	50	195878	ESNU-50-50-P	196384	ESNU-50-50-P-A
63	10	195879	ESNU-63-10-P	196385	ESNU-63-10-P-A
	25	195880	ESNU-63-25-P	196386	ESNU-63-25-P-A
	50	195881	ESNU-63-50-P	196387	ESNU-63-50-P-A



# Round cylinders ESNU

Technical data

FESTO

Ordering data			
∅ [mm]	Stroke [mm]	Part No.	Type
Variable stroke lengths			
8	1 ... 50	<b>14119</b>	<b>ESNU-8-...-P-A</b>
10	1 ... 50	<b>14118</b>	<b>ESNU-10-...-P-A</b>
12	1 ... 50	<b>14317</b>	<b>ESNU-12-...-P-A</b>
16	1 ... 50	<b>14316</b>	<b>ESNU-16-...-P-A</b>
20	1 ... 50	<b>14319</b>	<b>ESNU-20-...-P-A</b>
25	1 ... 50	<b>14318</b>	<b>ESNU-25-...-P-A</b>

# Round cylinders ESNU

Ordering data – Modular products



Ordering table									
Size	8	10	12	16	20	25	Condi- tions	Code	Enter code
<b>M</b> Module No.	<b>193996</b>	<b>193997</b>	<b>193998</b>	<b>193999</b>	<b>194000</b>	<b>194001</b>			
Function	Standard cylinder, single-acting pushing, based on ISO 6432							<b>ESNU</b>	ESNU
Piston Ø [mm]	8	10	12	16	20	25		-...	
Stroke [mm]	1 ... 50							-...	
Cushioning	Flexible cushioning rings/pads at both ends							-P	-P
<b>O</b> Position sensing	Via proximity sensor						<b>1</b>	-A	
<b>↓</b> End cap	Axial air connection							-MA	

**1** A Minimum stroke: 10 mm

**M** Mandatory data

**O** Options

Transfer order code

# Round cylinders ESNU

Ordering data – Modular products

Ordering table									
Size	8	10	12	16	20	25	Condi- tions	Code	Enter code
↓ [O] Extended male thread [mm]	Extended male piston rod thread 1 ... 15		1 ... 20		1 ... 25	1 ... 35	[2]	-...K2	
Shortened male thread [mm]	Shortened male piston rod thread 1 ... 4				1 ... 8			-...K6	
Female thread	-	-	-	-	(M4)	(M6)	[3]	-K3	
Special thread	Piston rod with special thread -					M10		-...K5	
Extended piston rod [mm]	Extended piston rod 1 ... 50							...K8	

- [2] **K2** Not with female thread K3, shortened male thread K6
- [3] **K3** Not with special thread K5, shortened male thread K6

[M] Mandatory data  
[O] Options

Transfer order code

-  -  -  -  -

# Round cylinders ESNU

Ordering data – Modular products



Ordering table							
Size	32	40	50	63	Condi- tions	Code	Enter code
<b>M</b> Module No.	<b>194002</b>	<b>194003</b>	<b>194004</b>	<b>194005</b>			
Function	Single-acting round cylinder					<b>ESNU</b>	ESNU
Piston Ø [mm]	32	40	50	63		-...	
Stroke [mm]	1 ... 50					-...	
Cushioning	Flexible cushioning rings/pads at both ends					<b>-P</b>	-P
<b>O</b> Position sensing	Via proximity sensor				<b>1</b>	<b>-A</b>	
<b>↓</b> End cap	Axial air connection					<b>-MA</b>	

**1** A Minimum stroke: 10 mm

**M** Mandatory data

**O** Options

Transfer order code

**ESNU** -  -  - **P**  -  -  -

# Round cylinders ESNU

Ordering data – Modular products

Ordering table							
Size	32	40	50	63	Condi- tions	Code	Enter code
↓							
⓪	Extended male thread [mm]	Piston rod with extended male thread 1 ... 35			2	-...K2	
	Shortened male thread [mm]	Piston rod with shortened male thread 1 ... 8		1 ... 10		-...K6	
	Female thread	(M6)	(M8)	(M10)	3	-K3	
	Special thread	Piston rod with special thread M10   M12   M16				-“...”K5	
	Extended piston rod [mm]	Extended piston rod 1 ... 50				...K8	

- 2 K2 Not with female thread K3, shortened male thread K6
- 3 K3 Not with special thread K5, shortened male thread K6

- M Mandatory data
- ⓪ Options

Transfer order code

-  -  -  -

- 1 - Type discontinued  
Available up until 2017

## Round cylinders DSN

Technical data

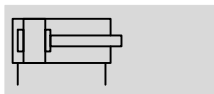

FESTO

Function  
P cushioning

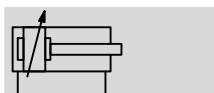

PPV cushioning



-  - Diameter  
8 ... 25 mm  
ISO 6432
-  - Stroke length  
1 ... 500 mm



General technical data						
Piston $\varnothing$	8	10	12	16	20	25
Conforms	ISO 6432					
Pneumatic connection	M5	M5	M5	M5	G $\frac{1}{8}$	G $\frac{1}{8}$
Piston rod thread	M4	M4	M6	M6	M8	M10x1.25
Stroke [mm]	1 ... 100		1 ... 200		1 ... 320	1 ... 500
Constructional design	Piston / Piston rod / Cylinder barrel					
Cushioning						
DSN- ... -P	Flexible cushioning rings/pads at both ends					
DSN- ... -PPV	-			Pneumatic cushioning, adjustable at both ends		
Cushioning length (PPV) [mm]	-			12	15	17
Type of mounting	Via accessories					
Mounting position	Any					

Note: This product conforms to ISO 1179-1 and to ISO 228-1

Operating and environmental conditions						
Piston $\varnothing$	8	10	12	16	20	25
Operating medium	Compressed air in accordance with ISO 8573-1:2010 [7:4:4]					
Note on operating/pilot medium	Operation with lubricated medium possible (in which case lubricated operation will always be required)					
Operating pressure [bar]	1.5 ... 10			1 ... 10		
Ambient temperature [°C]	-20 ... +80					
Corrosion resistance class CRC <sup>1)</sup>	2					

1) Corrosion resistance class CRC 2 to Festo standard FN 940070  
Moderate corrosion stress. Indoor applications in which condensation may occur. External visible parts with primarily decorative requirements for the surface and which are in direct contact with the ambient atmosphere typical for industrial applications.

- 2 - Type discontinued  
Available up until 2017

FESTO

## Round cylinders DSN

Technical data

Forces [N]						
Piston $\varnothing$	8	10	12	16	20	25
Theoretical force at 6 bar, advancing	30	47	68	121	189	295
Theoretical force at 6 bar, retracting	23	40	51	104	158	247

Weights [g]						
Piston $\varnothing$	8	10	12	16	20	25
Product weight with 0 mm stroke	34.6	37.3	75	89.8	186.8	238
Additional weight per 10 mm stroke	2.4	2.7	4	4.6	7.2	11
Moving load with 0 mm stroke	7.5	8.5	18.5	23	44	71
Moving load per 10 mm stroke	1	1	2	2	4	6

### Materials

Sectional view

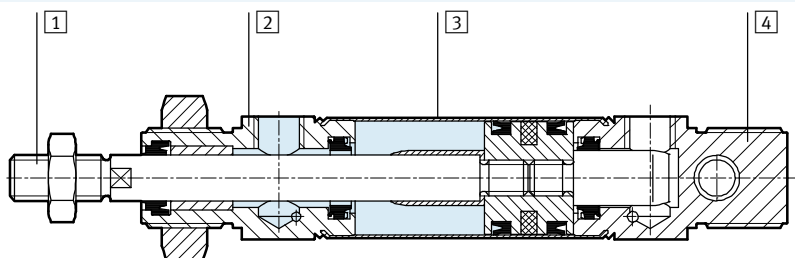

Round cylinder	
1	Piston rod High-alloy steel
2	Bearing cap Anodised aluminium
3	Cylinder barrel High-alloy stainless steel
4	End cap Anodised aluminium
-	Seals TPE-U(PU), NBR
	Note on materials RoHS compliant

**- 1 - Type discontinued**  
**Available up until 2017**

## Round cylinders DSN

Technical data

**FESTO**

### Dimensions

Download CAD data → [www.festo.com](http://www.festo.com)

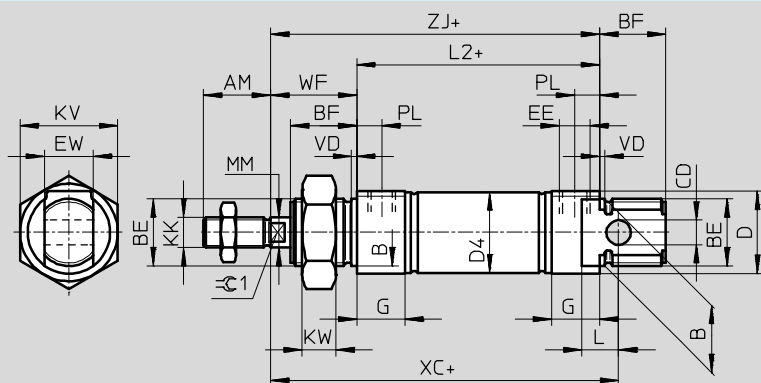

Note  
 Piston rod nut is not included in scope of delivery for  $\varnothing 8 \dots 20$ .  
 + = plus stroke length

$\varnothing$ [mm]	AM	B $\varnothing$ h9	BE	BF	CD $\varnothing$ H9	D $\varnothing$	D4 $\varnothing$	EE	EW	G	KK
8	12	12	M12x1.25	12	4	15	9.3	M5	8	10	M4
10							11.3				
12	16	16	M16x1.5	17	6	20	13.3		12	M6	
16							17.3				
20	20	22	M22x1.5	20	8	27	21.3	G1/8	16	16	M8
25	22			22			22				26.5

$\varnothing$ [mm]	KV	KW	L	L2	MM $\varnothing$	PL	VD	WF	XC $\pm 1$	ZJ	$\sqrt{Ra} 1$
8	19	6	6	46	4	6	2	16	64	62	-
10											
12	24	8	9	50	6			22	75	72	5
16				56					82	78	
20	32	11	12	68	8	8.2	24	95	92	7	
25				69.5							10

Note: This product conforms to ISO 1179-1 and to ISO 228-1



 Type discontinued  
Available up until 2017

FESTO

## Round cylinders DSN

Technical data

Ordering data			
Piston Ø [mm]	Stroke [mm]	P – Flexible cushioning rings/pads at both ends	
		Part No.	Type
8	10	5033	DSN-8-10-P
	25	5034	DSN-8-25-P
	40	5035	DSN-8-40-P
	50	5036	DSN-8-50-P
	80	5037	DSN-8-80-P
	100	5038	DSN-8-100-P
10	10	5040	DSN-10-10-P
	25	5041	DSN-10-25-P
	40	5042	DSN-10-40-P
	50	5043	DSN-10-50-P
	80	5044	DSN-10-80-P
	100	5045	DSN-10-100-P
12	10	5047	DSN-12-10-P
	25	5048	DSN-12-25-P
	40	5049	DSN-12-40-P
	50	5050	DSN-12-50-P
	80	5051	DSN-12-80-P
	100	5052	DSN-12-100-P
	125	8519	DSN-12-125-P
	160	5053	DSN-12-160-P
	200	5054	DSN-12-200-P

**- 1 - Type discontinued**  
**Available up until 2017**

## Round cylinders DSN

Technical data

**FESTO**

Ordering data					
Piston Ø [mm]	Stroke [mm]	P – Flexible cushioning rings/pads at both ends		PPV – Pneumatic cushioning, adjustable at both ends	
		Part No.	Type	Part No.	Type
16	10	5056	DSN-16-10-P	-	
	25	5057	DSN-16-25-P		
	40	5058	DSN-16-40-P	14534	DSN-16-40-PPV
	50	5059	DSN-16-50-P	14535	DSN-16-50-PPV
	80	5060	DSN-16-80-P	14536	DSN-16-80-PPV
	100	5061	DSN-16-100-P	14537	DSN-16-100-PPV
	125	8520	DSN-16-125-P	14538	DSN-16-125-PPV
	160	5062	DSN-16-160-P	14539	DSN-16-160-PPV
	200	5063	DSN-16-200-P	14540	DSN-16-200-PPV
20	10	5065	DSN-20-10-P	-	
	25	5066	DSN-20-25-P		
	40	5067	DSN-20-40-P	8743	DSN-20-40-PPV
	50	5068	DSN-20-50-P	8744	DSN-20-50-PPV
	80	5069	DSN-20-80-P	8745	DSN-20-80-PPV
	100	5070	DSN-20-100-P	8746	DSN-20-100-PPV
	125	8521	DSN-20-125-P	8747	DSN-20-125-PPV
	160	5071	DSN-20-160-P	8748	DSN-20-160-PPV
	200	5072	DSN-20-200-P	8749	DSN-20-200-PPV
	250	8522	DSN-20-250-P	8750	DSN-20-250-PPV
	300	5073	DSN-20-300-P	8751	DSN-20-300-PPV
	320	34710	DSN-20-320-P	34712	DSN-20-320-PPV
	25	10	5075	DSN-25-10-P	-
25		5076	DSN-25-25-P		
40		5077	DSN-25-40-P	9666	DSN-25-40-PPV
50		5078	DSN-25-50-P	9667	DSN-25-50-PPV
80		5079	DSN-25-80-P	9668	DSN-25-80-PPV
100		5080	DSN-25-100-P	9669	DSN-25-100-PPV
125		8523	DSN-25-125-P	8531	DSN-25-125-PPV
160		5081	DSN-25-160-P	9670	DSN-25-160-PPV
200		5082	DSN-25-200-P	9671	DSN-25-200-PPV
250		8524	DSN-25-250-P	8532	DSN-25-250-PPV
300		5083	DSN-25-300-P	9672	DSN-25-300-PPV
320		34711	DSN-25-320-P	34713	DSN-25-320-PPV
400		32298	DSN-25-400-P	32300	DSN-25-40-PPV
500		32299	DSN-25-500-P	32301	DSN-25-500-PPV

 Type discontinued  
Available up until 2017

## Round cylinders DSN

Technical data

Ordering data					
Piston Ø [mm]	Stroke [mm]	P – Flexible cushioning rings/pads at both ends		PPV – Pneumatic cushioning, adjustable at both ends	
		Part No.	Type	Part No.	Type
Variable stroke lengths			Variable stroke lengths		
8	1 ... 100	<b>5032</b>	<b>DSN-8-...-P</b>	-	
10	1 ... 100	<b>5039</b>	<b>DSN-10-...-P</b>	-	
12	1 ... 200	<b>5046</b>	<b>DSN-12-...-P</b>	-	
16	1 ... 200	<b>5055</b>	<b>DSN-16-...-P</b>	-	
20	1 ... 320	<b>5064</b>	<b>DSN-20-...-P</b>	-	
25	1 ... 500	<b>5074</b>	<b>DSN-25-...-P</b>	-	
16	1 ... 200	-	-	<b>14533</b>	<b>DSN-16-...-PPV</b>
20	1 ... 320	-	-	<b>8742</b>	<b>DSN-20-...-PPV</b>
25	1 ... 500	-	-	<b>9665</b>	<b>DSN-25-...-PPV</b>

- 7 - Type discontinued  
Available up until 2017



## Round cylinders ESN

Technical data

FESTO

Function  
P cushioning



-  - Diameter  
8 ... 25 mm  
ISO 6432
-  - Stroke length  
1 ... 50 mm



General technical data						
Piston Ø	8	10	12	16	20	25
Conforms	ISO 6432					
Pneumatic connection	M5	M5	M5	M5	G $\frac{1}{8}$	G $\frac{1}{8}$
Piston rod thread	M4	M4	M6	M6	M8	M10x1.25
Stroke	[mm]	1 ... 50				
Constructional design	Piston / Piston rod / Cylinder barrel					
Cushioning	Flexible cushioning rings/pads at both ends					
Type of mounting	Via accessories					
Mounting position	Any					

- | - Note: This product conforms to ISO 1179-1 and to ISO 228-1

Operating and environmental conditions						
Piston Ø	8	10	12	16	20	25
Operating medium	Compressed air in accordance with ISO 8573-1:2010 [7:4:4]					
Note on operating/pilot medium	Operation with lubricated medium possible (in which case lubricated operation will always be required)					
Operating pressure	[bar]	1.5 ... 10			1.2 ... 10	
Ambient temperature	[°C]	-20 ... +80				
Corrosion resistance class CRC <sup>1)</sup>	2					

1) Corrosion resistance class CRC 2 to Festo standard FN 940070  
Moderate corrosion stress. Indoor applications in which condensation may occur. External visible parts with primarily decorative requirements for the surface and which are in direct contact with the ambient atmosphere typical for industrial applications.

## Round cylinders ESN

Technical data

Force [N] and impact energy [J]						
Piston $\varnothing$	8	10	12	16	20	25
Theoretical force at 6 bar, advancing	24	41	61	107	169	270
Spring return force						
10 mm stroke	4.9	4.9	6.3	13.2	18.3	22.9
25 mm stroke	4.1	4.1	5.4	11.9	16.5	21.2
50 mm stroke	2.8	4.8	3.9	9.8	13.6	18.5
Impact energy at end positions	0.03	0.05	0.07	0.15	0.20	0.30

Weight [g]						
Piston $\varnothing$	8	10	12	16	20	25
Product weight with 0 mm stroke	40	43	80	96	200	260
Additional weight per 10 mm stroke	2.3	2.5	4,1	4.7	7.1	10,9
Moving load with 0 mm stroke	34.6	37.3	75	89.9	186.8	238
Moving load per 10 mm stroke	2.4	2.7	4	4.6	7.2	11

### Materials

Sectional view

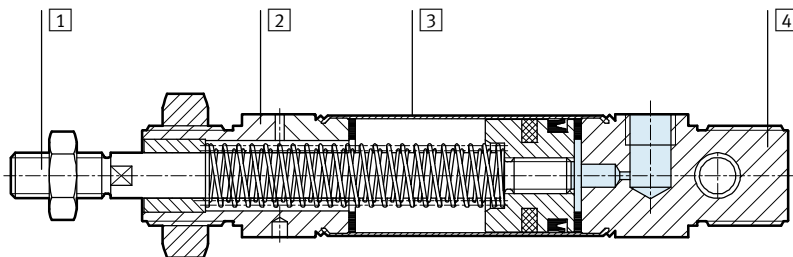

Standard cylinder	
1	Piston rod High-alloy stainless steel
2	Bearing cap Anodised aluminium
3	Cylinder barrel High-alloy stainless steel
4	End cap Anodised aluminium
-	Seals TPE-U(PU), NBR
-	Spring Spring steel
Note on materials RoHS compliant	

- 1 - Type discontinued  
Available up until 2017

## Round cylinders ESN

Technical data

FESTO

### Dimensions

Download CAD data → [www.festo.com](http://www.festo.com)

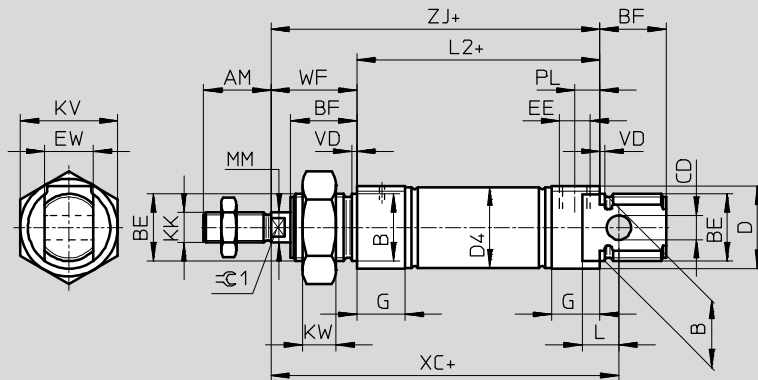

Note  
Piston rod nut is not included in scope of delivery for  $\varnothing 8 \dots 20$ .  
+ = plus stroke length

$\varnothing$ [mm]	AM	B $\varnothing$ h9	BE	BF	CD $\varnothing$ H9	D $\varnothing$	D4 $\varnothing$	EE	EW	G	KK
8	12	12	M12x1.25	12	4	15	9.3	M5	8	10	M4
10							11.3				
12	16	16	M16x1.5	17	6	20	13.3				
16							17.3				
20	20	22	M22x1.5	20	8	27	21.3	G $\frac{1}{8}$	16	16	M8
25	22			22			22				26.5

$\varnothing$ [mm]	KV	KW	L	L2	MM $\varnothing$	PL	VD	WF	XC $\pm 1$	ZJ	$\approx \text{C1}$
8	19	6	6	46	4	6	2	16	64	62	-
10											
12	24	8	9	50	6	8.2	22	75	72	5	
16				56				82	78		
20	32	11	12	68	10	8.2	24	95	92	7	
25				69.5				104	97.5	9	

Note: This product conforms to ISO 1179-1 and to ISO 228-1

- 2 - Type discontinued  
Available up until 2017

FESTO

## Round cylinders ESN

Technical data

Ordering data			
∅ [mm]	Stroke [mm]	Part No.	Type
8	10	5086	ESN-8-10-P
	25	5087	ESN-8-25-P
	50	5088	ESN-8-50-P
10	10	5089	ESN-10-10-P
	25	5090	ESN-10-25-P
	50	5091	ESN-10-50-P
12	10	5092	ESN-12-10-P
	25	5093	ESN-12-25-P
	50	5094	ESN-12-50-P
16	10	5095	ESN-16-10-P
	25	5096	ESN-16-25-P
	50	5097	ESN-16-50-P
20	10	5098	ESN-20-10-P
	25	5099	ESN-20-25-P
	50	5100	ESN-20-50-P
25	10	5101	ESN-25-10-P
	25	5102	ESN-25-25-P
	50	5103	ESN-25-50-P

Ordering data			
∅ [mm]	Stroke [mm]	Part No.	Type
Variable stroke lengths			
8	1 ... 50	11651	ESN-8-...-P
10	1 ... 50	11652	ESN-10-...-P
12	1 ... 50	11653	ESN-12-...-P
16	1 ... 50	11654	ESN-16-...-P
20	1 ... 50	11655	ESN-20-...-P
25	1 ... 50	11656	ESN-25-...-P

# Round cylinders DSNU/DSNUP/DSN/ESNU/ESN

Accessories

FESTO

## Foot mounting HBN/CRHBN

Scope of delivery:

HBN/CRHBN-...x1: 1 foot

HBN/CRHBN-...x2: 2 feet and 1 nut

Material:

HBN: Galvanised steel

CRHBN: High-alloy stainless steel

Free of copper and PTFE

RoHS-compliant

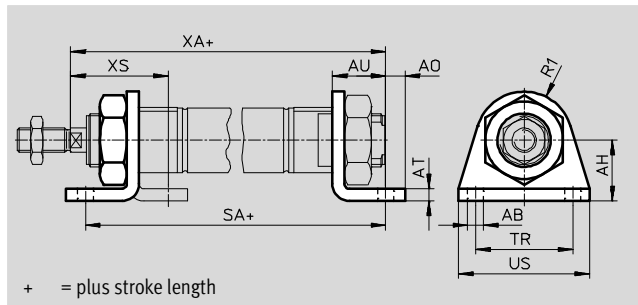

+ = plus stroke length

Dimensions and ordering data														
For $\varnothing$ [mm]	AB $\varnothing$	AH	AO	AT	AU	R1	SA		TR	US	XA		XS	
							DSNU-KP				DSNU-KP		DSNU-KP	
8, 10	4.5	16	5	3	11	10	68	97	25	35	73	102	24	-
12	5.5	20	6	4	14	13	78	116	32	42	86	124	32	-
16	5.5	20	6	4	14	13	84	122	32	42	92	130	32	-
20	6.6	25	8	5	17	20	102	149	40	54	109	156	36	-
25	6.6	25	8	5	17	20	103.5	151.5	40	54	114.5	162.5	40	-

For $\varnothing$ [mm]	Basic version				High corrosion protection			
	CRC <sup>1)</sup>	Weight [g]	Part No.	Type	CRC <sup>1)</sup>	Weight [g]	Part No.	Type
8, 10	2	20	5123	HBN-8/10x1	-	-	-	-
	2	55	5124	HBN-8/10x2	-	-	-	-
12, 16	2	40	5125	HBN-12/16x1	4	40	161866	CRHBN-12/16x1
	2	105	5126	HBN-12/16x2	4	97	162999	CRHBN-12/16x2
20, 25	2	90	5127	HBN-20/25x1	4	55	161867	CRHBN-20/25x1
	2	220	5128	HBN-20/25x2	4	100	162998	CRHBN-20/25x2

1) Corrosion resistance class CRC 2 to Festo standard FN 940070

Moderate corrosion stress. Indoor applications in which condensation may occur. External visible parts with primarily decorative requirements for the surface and which are in direct contact with the ambient atmosphere typical for industrial applications.

Corrosion resistance class CRC 4 to Festo standard FN 940070

Particularly high corrosion stress. Outdoor exposure under extreme corrosive conditions. Parts exposed to aggressive media, for instance in the chemical or food industries. These applications may need to be supported by special tests (→ also FN 940082) using appropriate media.



# Round cylinders DSNU/DSNUP/DSN/ESNU/ESN

Accessories

## Foot mounting HBN/CRH

Material:

- HBN: Galvanised steel
- CRH: High-alloy stainless steel
- Free of copper and PTFE
- RoHS-compliant

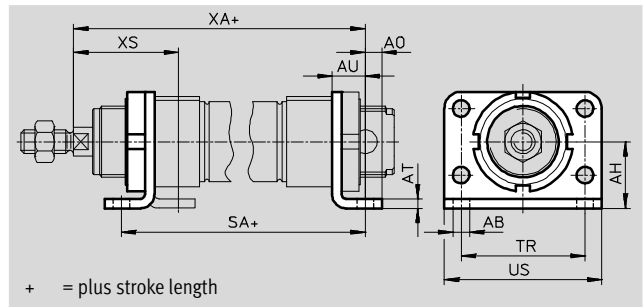

Dimensions and ordering data													
For $\varnothing$	AB	AH	AO	AT	AU	SA		TR	US	XA		XS	
[mm]	$\varnothing$					DSNU-KP				DSNU-KP		DSNU-KP	
32	7	28	7	4	14	97.5	151	52	66	117.5	171	44	-
40	9	33	10	5	20	124.6	192.1	60	80	138.6	206.1	49	-
50	9	40	10	6	20	126.2	202.7	70	90	150.2	226.7	58	-
63	9	45	10	6	20	134.2	218.7	76	96	159.2	243.7	59	-

For $\varnothing$	Basic version				High corrosion protection			
	CRC <sup>1)</sup>	Weight [g]	Part No.	Type	CRC <sup>1)</sup>	Weight [g]	Part No.	Type
32	2	247	<b>195851</b>	<b>HBN-32x2</b>	4	237	<b>162951</b>	<b>CRH-32</b>
40	2	446	<b>195852</b>	<b>HBN-40x2</b>	4	341	<b>162952</b>	<b>CRH-40</b>
50	2	666	<b>195853</b>	<b>HBN-50x2</b>	4	559	<b>162953</b>	<b>CRH-50</b>
63	2	816	<b>195854</b>	<b>HBN-63x2</b>	4	680	<b>162954</b>	<b>CRH-63</b>

1) Corrosion resistance class CRC 2 to Festo standard FN 940070  
 Moderate corrosion stress. Indoor applications in which condensation may occur. External visible parts with primarily decorative requirements for the surface and which are in direct contact with the ambient atmosphere typical for industrial applications.  
 Corrosion resistance class CRC 4 to Festo standard FN 940070  
 Particularly high corrosion stress. Outdoor exposure under extreme corrosive conditions. Parts exposed to aggressive media, for instance in the chemical or food industries. These applications may need to be supported by special tests (→ also FN 940082) using appropriate media.

# Round cylinders DSNU/DSNUP/DSN/ESNU/ESN



Accessories

## Flange mounting FBN/CRFBN

Material:

FBN: Galvanised steel

CRFBN: High-alloy stainless steel

Free of copper and PTFE

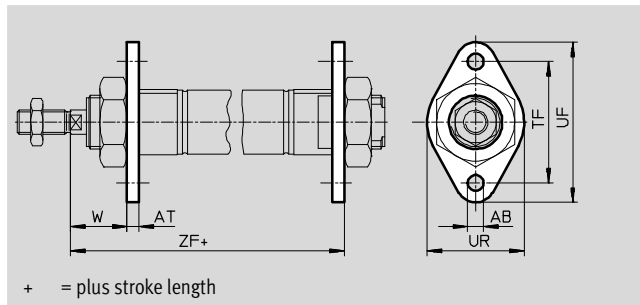

+ = plus stroke length

Dimensions and ordering data								
For $\varnothing$	AB	AT	TF	UF	UR	W	ZF	
[mm]	$\varnothing$							DSNU-KP
8, 10	4.5	3	30	40	25	13	65	94
12	5.5	4	40	53	30	18	76	114
16	5.5	4	40	53	30	18	82	120
20	6.6	5	50	66	40	19	97	144
25	6.6	5	50	66	40	23	102.5	150.5

For $\varnothing$	Basic version				High corrosion protection			
	CRC <sup>1)</sup>	Weight [g]	Part No.	Type	CRC <sup>1)</sup>	Weight [g]	Part No.	Type
8, 10	2	12	5129	FBN-8/10	-	-	-	-
12, 16	2	26	5130	FBN-12/16	4	26	161864	CRFBN-12/16
20, 25	2	52	5131	FBN-20/25	4	52	161865	CRFBN-20/25

1) Corrosion resistance class CRC 2 to Festo standard FN 940070

Moderate corrosion stress. Indoor applications in which condensation may occur. External visible parts with primarily decorative requirements for the surface and which are in direct contact with the ambient atmosphere typical for industrial applications.

Corrosion resistance class CRC 4 to Festo standard FN 940070

Particularly high corrosion stress. Outdoor exposure under extreme corrosive conditions. Parts exposed to aggressive media, for instance in the chemical or food industries. These applications may need to be supported by special tests (➔ also FN 940082) using appropriate media.

# Round cylinders DSNU/DSNUP/DSN/ESNU/ESN

Accessories

## Flange mounting FBN/CRFV

Material:

FBN: Galvanised steel

CRFV: High-alloy stainless steel

Free of copper and PTFE

RoHS-compliant

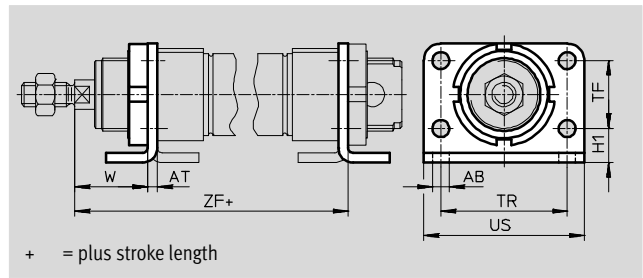

Dimensions and ordering data									
For $\varnothing$	AB	AT	H1	TF	TR	US	W	ZF	
[mm]	$\varnothing$								-KP
32	7	4	14	28	52	66	30	107.5	161
40	9	5	18	30	60	80	29	123.6	191.1
50	9	6	20	40	70	90	38	136.2	212.6
63	9	6	20	50	76	96	39	145.2	229.7

For $\varnothing$	Basic version				High corrosion protection			
	CRC <sup>1)</sup>	Weight [g]	Part No.	Type	CRC <sup>1)</sup>	Weight [g]	Part No.	Type
32	1	102	<b>195855</b>	<b>FBN-32</b>	4	102	<b>161858</b>	<b>CRFV-32</b>
40	1	190	<b>195856</b>	<b>FBN-40</b>	4	190	<b>161859</b>	<b>CRFV-40</b>
50	1	290	<b>195857</b>	<b>FBN-50</b>	4	290	<b>161860</b>	<b>CRFV-50</b>
63	1	365	<b>195858</b>	<b>FBN-63</b>	4	365	<b>161861</b>	<b>CRFV-63</b>

1) Corrosion resistance class CRC 1 to Festo standard FN 940070

Low corrosion stress. For dry indoor applications or transport and storage protection. Also applies to parts behind covers, in the non-visible interior area, and parts which are covered in the application (e.g. drive trunnions).

Corrosion resistance class CRC 4 to Festo standard FN 940070

Particularly high corrosion stress. Outdoor exposure under extreme corrosive conditions. Parts exposed to aggressive media, for instance in the chemical or food industries. These applications may need to be supported by special tests (➔ also FN 940082) using appropriate media.

# Round cylinders DSNU/DSNUP/DSN/ESNU/ESN

Accessories

FESTO

## Swivel mounting SBN

Material:

Mounting ring: Wrought aluminium alloy, anodised

Bearing: Bronze

Screws: Galvanised steel

Bracket: Steel

Cannot be used on the bearing cap in combination with bellows kit DADB.

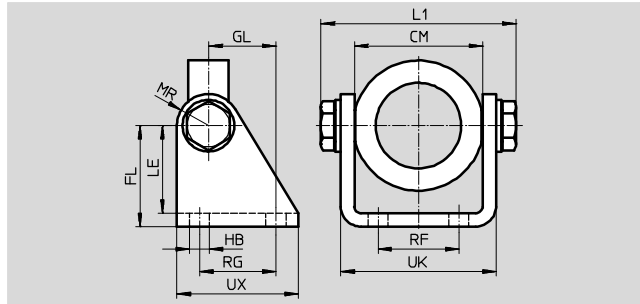
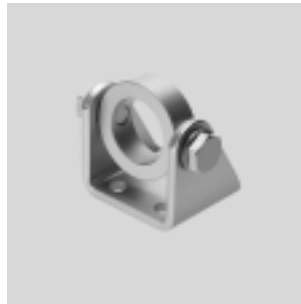

### Dimensions and ordering data

For Ø	CM	FL	GL	HB	L1	LE	MR	RF	RG	UK	UX	CRC <sup>1)</sup>	Weight	Part No.	Type
[mm]					max.								[g]		
20/25	38.1+0.4	35	20	7	60.2	31	12	20	24	46.1	40	2	200	539927	SBN-20/25
32	46.1+0.2	40	27	9	72.2	35	13	28	30	56.1	50	2	295	539924	SBN-32
40	57.1+0.2	45	30	9	88.2	39	14	36	34	69.1	54	2	465	539925	SBN-40
50/63	70.1+0.4	50	34	9	102.2	44	16	42	35	82.1	65	2	670	539926	SBN-50/63

1) Corrosion resistance class CRC 2 to Festo standard FN 940070

Moderate corrosion stress. Indoor applications in which condensation may occur. External visible parts with primarily decorative requirements for the surface and which are in direct contact with the ambient atmosphere typical for industrial applications.

## Swivel mounting WBN

Material:

Galvanised steel

Free of copper and PTFE

RoHS-compliant

Cannot be used on the bearing cap in combination with bellows kit DADB.

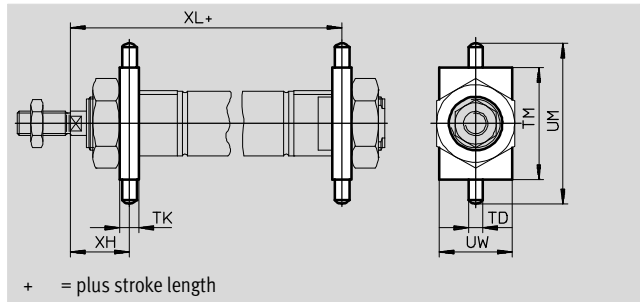

### Dimensions and ordering data

For Ø	TD	TK	TM	UM	UW	XH	XL	CRC <sup>1)</sup>	Weight	Part No.	Type
[mm]	Ø						DSNU-KP		[g]		
8, 10	4	6	26	38	20	13	65	94	20	8608	WBN-8/10
12	6	8	38	58	25	18	76	114	50	8609	WBN-12/16
16	6	8	38	58	25	18	82	120	50	8609	WBN-12/16
20	6	8	46	66	30	20	96	143	70	8610	WBN-20/25
25	6	8	46	66	30	24	101.5	149.5	70	8610	WBN-20/25
32	8	12	50	76	40	28	109.5	163	130	195863	WBN-32
40	10	15	60	92	50	31.5	126.1	193.6	240	195864	WBN-40
50	12	20	80	116	65	34	140.2	216.7	610	195865	WBN-50/63
63	12	20	80	116	65	35	149.2	233.7	610	195865	WBN-50/63

1) Corrosion resistance class CRC 2 to Festo standard FN 940070

Moderate corrosion stress. Indoor applications in which condensation may occur. External visible parts with primarily decorative requirements for the surface and which are in direct contact with the ambient atmosphere typical for industrial applications.

# Round cylinders DSNU/DSNUP/DSN/ESNU/ESN

Accessories

## Clevis foot LBN/CRLBN

Material:

LBN: Galvanised steel

CRLBN: High-alloy stainless steel

Free of copper and PTFE

RoHS-compliant

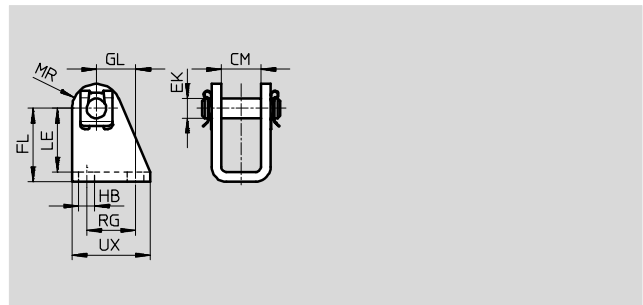

### Dimensions and ordering data

For Ø	CM	EK Ø	FL	GL	HB	LE	MR	RG	UX
[mm]									
8, 10	8.1	4	24 +0.3/-0.2	13.8	4.5	21.5	5	12.5	20
12, 16	12.1	6	27 +0.3/-0.2	13	5.5	24	7	15	25
20, 25	16.1	8	30 +0.4/-0.2	16	6.6	26	10	20	32
32	16.1	10	35 +0.4/-0.2	18.5	6.6	31	11	24	35
40	18.1	12	40 +0.4/-0.2	24.5	9	35	13	30	45
50, 63	21.1	16	45 +0.5/-0.2	28	9	39	14	34	50

For Ø [mm]	Basic version				High corrosion protection			
	CRC <sup>1)</sup>	Weight [g]	Part No.	Type	CRC <sup>1)</sup>	Weight [g]	Part No.	Type
8, 10	1	20	<b>6057</b>	<b>LBN-8/10</b>	-	-	-	-
12, 16	1	40	<b>6058</b>	<b>LBN-12/16</b>	4	39	<b>161862</b>	<b>CRLBN-12/16</b>
20, 25	1	84	<b>6059</b>	<b>LBN-20/25</b>	4	82	<b>161863</b>	<b>CRLBN-20/25</b>
32	1	110	<b>195860</b>	<b>LBN-32</b>	4	106	<b>195866</b>	<b>CRLBN-32</b>
40	1	191	<b>195861</b>	<b>LBN-40</b>	4	185	<b>195867</b>	<b>CRLBN-40</b>
50, 63	1	300	<b>195862</b>	<b>LBN-50/63</b>	4	293	<b>195868</b>	<b>CRLBN-50/63</b>

1) Corrosion resistance class CRC 1 to Festo standard FN 940070

Low corrosion stress. For dry indoor applications or transport and storage protection. Also applies to parts behind covers, in the non-visible interior area, and parts which are covered in the application (e.g. drive trunnions).







Corrosion resistance class CRC 4 to Festo standard FN 940070

Particularly high corrosion stress. Outdoor exposure under extreme corrosive conditions. Parts exposed to aggressive media, for instance in the chemical or food industries. These applications may need to be supported by special tests (→ also FN 940082) using appropriate media.

# Round cylinders DSNU/DSNUP/DSN/ESNU/ESN

Accessories

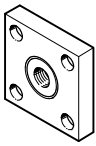
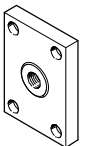

FESTO

Ordering data – Piston rod attachments				Technical data → Internet: piston rod attachments							
Designation	For Ø	Part No.	Type	Designation	For Ø	Part No.	Type				
<b>Rod eye SGS</b>				<b>Rod clevis SGA</b>							
	8	9253	SGS-M4		8	-					
	10										
	12	9254	SGS-M6		12						
	16										
	20	9255	SGS-M8		20						
	25	9261	SGS-M10x1.25		25						
	32	9262	SGS-M12x1.25		32			32654	SGA-M10x1.25		
	40				10767			SGA-M12x1.25			
	50				10768			SGA-M16x1.5			
63	9263	SGS-M16x1.5	63								
<b>Rod clevis SG</b>				<b>Self-aligning rod coupler FK</b>							
	8	6532	SG-M4		8	6528	FK-M4				
	10										
	12	3110	SG-M6		12			2061	FK-M6		
	16										
	20	3111	SG-M8		20			2062	FK-M8		
	25	6144	SG-M10x1.25		25			6140	FK-M10x1.25		
	32	6145	SG-M12x1.25		32			6141	FK-M12x1.25		
	40				6146					SG-M16x1.5	40
	50										6142
63			63								
<b>Coupling piece KSG</b>				<b>Coupling piece KSZ</b>							
	12	-			12	36123	KSZ-M6				
	16										
	20				36124	KSZ-M8	20				
	25	36125	KSZ-M10x1.25								
	32	32963	KSG-M10x1.25		32	36126	KSZ-M12x1.25				
	40				32964			KSZ-M12x1.25			
	50				32965			KSZ-M16x1.5			
63			63								
<b>Hex nut MSK</b>											
	16	189007	MSK-M16X1.5								
	20	189009	MSK-M22X1.5								
	25										

# Round cylinders DSNU/DSNUP/DSN/ESNU/ESN

Accessories

**FESTO**

Ordering data – Piston rod attachments, corrosion resistant				Technical data → Internet: crsg			
Designation	For Ø	Part No.	Type	Designation	For Ø	Part No.	Type
Rod eye CRSGS				Rod clevis CRSG			
	12	195580	CRSGS-M6		12	13567	CRSG-M6
	16				16		
	20	195581	CRSGS-M8		20	13568	CRSG-M8
	25	195582	CRSGS-M10x1.25		25	13569	CRSG-M10x1.25
	32				32		
	40	195583	CRSGS-M12x1.25		40	13570	CRSG-M12x1.25
	50	195584	CRSGS-M16x1.5		50	13571	CRSG-M16x1.5
63			63				
Self-aligning rod coupler CRFK				-			
	25	2305778	CRFK-M10x1.25				
	32						
	40	2305779	CRFK-M12x1.25				
	50	2490673	CRFK-M16x1.5				
	63						

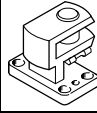
Ordering data – Mounting attachments				Technical data → Internet: clevis foot			
Designation	For Ø	Part No.	Type	Designation	For Ø	Part No.	Type
Clevis foot LBG				Right-angle clevis foot LQG			
	32	31761	LBG-32		32	31768	LQG-32
	40	31762	LBG-40		40	31769	LQG-40
	50	31763	LBG-50		50	31770	LQG-50
	63	31764	LBG-63		63	31771	LQG-63

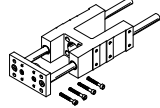
Ordering data – Guide units					Technical data → Internet: feng	
	For Ø	Stroke [mm]	With recirculating ball bearing guide		With plain-bearing guide	
			Part No.	Type	Part No.	Type
	8, 10	1 ... 100	35197	FEN-8/10-...-KF	35196	FEN-8/10-...-GF
	12, 16	1 ... 200	33481	FEN-12/16-...-KF	19168	FEN-12/16-...-GF
	20	2 ... 250	33482	FEN-20-...-KF	19169	FEN-20-...-GF
	25	2 ... 250	33483	FEN-25-...-KF	19170	FEN-25-...-GF

# Round cylinders DSNU/DSNUP/DSN/ESNU/ESN

Accessories



## Bellows kit DADB



General technical data								
Type DADB-S1-	12	16	20	25	32	40	50	63
Max. stroke range of cylinder <sup>1)</sup>								
DSNU	[mm]	10 ... 200	10 ... 320	10 ... 500				
ESNU <sup>2)</sup>	[mm]	–	10 ... 50					
Type of mounting	With threaded pin							
Mounting position	Any							
Resistance to media	Dust, chippings, oil, grease, fuel (→ Internet: Resistance to media)							
Ambient temperature <sup>3)</sup>	[°C]	–10 ... +80						
Corrosion resistance class CRC <sup>4)</sup>	3							

- 1) In combination with the bellows kit DADB
- 2) Slight change in spring return force
- 3) Note operating range of proximity sensors and cylinder
- 4) Corrosion resistance class CRC 3 to Festo standard FN 940070  
High corrosion stress. Outdoor exposure under moderate corrosive conditions. External visible parts with primarily functional requirements for the surface and which are in direct contact with a normal industrial environment.

## Materials

Sectional view

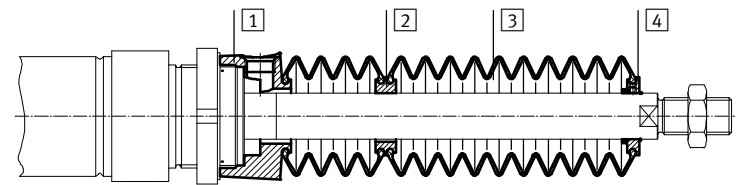

Bellows		
1	Connection	Polyamide
2	Intermediate piece	Polyamide
3	Bellows	NBR
4	End piece	Polyamide
–	O-ring	NBR
Note on materials		Free of copper and PTFE
		RoHS compliant



## Round cylinders DSNU/DSNUP/DSN/ESNU/ESN

FESTO

Accessories

Weight [g]				
Type DADB-S1- Stroke [mm]	12	16	20	25
10 ... 50	7	7	20	19
51 ... 100	9	9	32	31
101 ... 150	13	13	45	44
151 ... 200	16	16	58	57
201 ... 250	-	-	73	72
251 ... 300	-	-	85	84
301 ... 350	-	-	100	98
351 ... 400	-	-	-	109
401 ... 450	-	-	-	124
451 ... 500	-	-	-	136

Weight [g]				
Type DADB-S1- Stroke [mm]	32	40	50	63
10 ... 50	29	34	55	55
51 ... 100	41	49	75	75
101 ... 150	51	60	89	89
151 ... 200	66	78	113	113
201 ... 250	79	93	131	131
251 ... 300	92	108	149	149
301 ... 350	92	108	151	151
351 ... 400	104	122	169	169
401 ... 450	117	137	187	187
451 ... 500	117	137	189	189

# Round cylinders DSNU/DSNUP/DSN/ESNU/ESN

Accessories

FESTO

## Speed of travel $v$ as a function of tube length $l$



The bellows kit is a leak-free system. To prevent unwanted media from being drawn in, the supply and exhaust air must be ducted via a pressure compensation hole in the

connection part **1**. The pressure generated in the bellows kit by the positioning motion is primarily defined by speed of travel

and tubing length. The recommended tubing length based on the travel speed of the drive can be read from the graph.

### Advancing

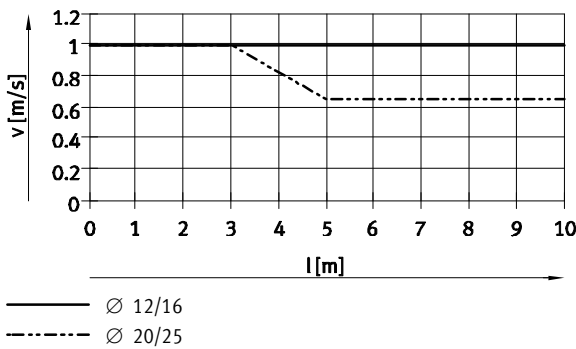

### Retracting

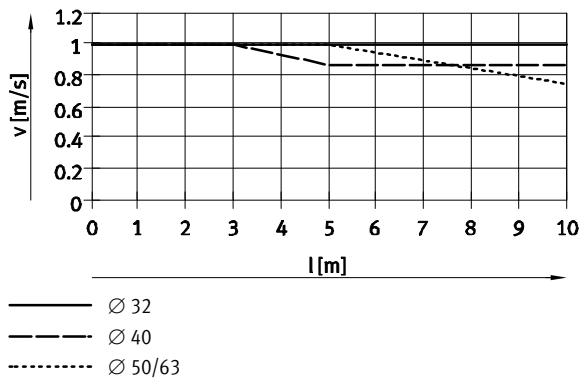
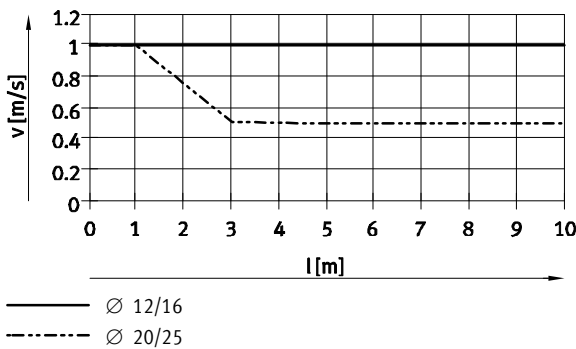

**Note**  
The push-in fittings opposite must be used for the pressure compensation hole. Silencers can be used as an alternative. This reduces the travel speed slightly.

Tubing length and push-in fitting for pressure compensation hole			
Ø [mm]	Tubing O.D. [mm]	Push-in fitting	
		Part No.	Type
12, 16, 20, 25	6	153317	QSM-M5-6-I
		578371	NPQH-DK-M5-Q6-P10
		578335	NPQH-D-M5-Q6-P10
		578359	NPQH-D-M5-S6-P10
32, 40	8	186109	QS-G $\frac{1}{8}$ -8-I
		578376	NPQH-DK-G18-Q8-P10
		578362	NPQH-D-G18-S8-P10
50, 63	12	186350	QS-G $\frac{1}{4}$ -12
		578344	NPQH-D-G14-Q12-P10
		578366	NPQH-D-G14-S12-P10

# Round cylinders DSNU/DSNUP/DSN/ESNU/ESN

Accessories

FESTO

## Dimensions

Download CAD data → [www.festo.com](http://www.festo.com)

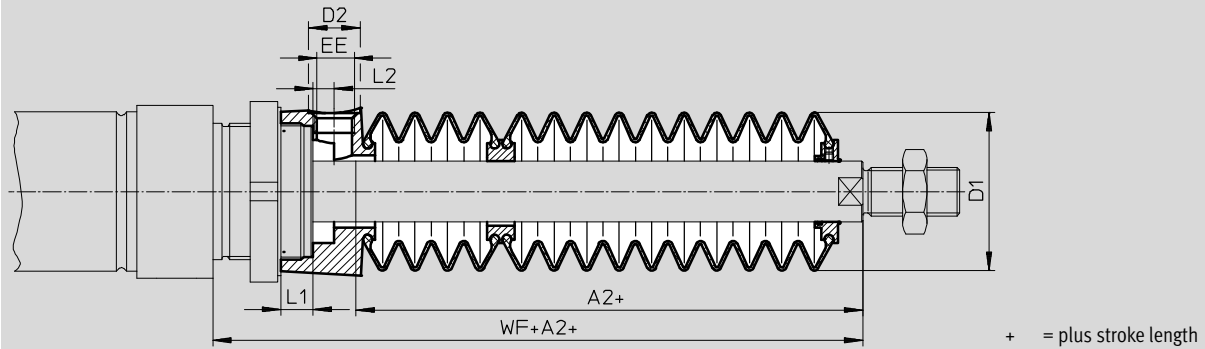

Ø Stroke [mm]	12/16						20							
	A2 <sup>1)</sup>	D1 max.	D2	EE	L1	L2	WF+A2	A2 <sup>1)</sup>	D1 max.	D2	EE	L1	L2	WF+A2
10 ... 50	23	22	8.5	M5	5	3.2	45	22	29	8.5	M5	4.2	2.7	46
51 ... 100	34						56	34						58
101 ... 150	48						70	47						71
151 ... 200	59						81	60						84
201 ... 250	-						-	75						99
251 ... 300	-						-	86						110
301 ... 350	-						-	101						125
351 ... 400	-						-	-						-
401 ... 450	-						-	-						-
451 ... 500	-						-	-						-

Ø Stroke [mm]	25						
	A2 <sup>1)</sup>	D1 max.	D2	EE	L1	L2	WF+A2
10 ... 50	22	29	8.5	M5	4.2	2.7	50
51 ... 100	34						62
101 ... 150	47						75
151 ... 200	60						88
201 ... 250	75						103
251 ... 300	86						114
301 ... 350	101						129
351 ... 400	112						140
401 ... 450	127						155
451 ... 500	138						166

1) The dimension corresponds to the K8 value (extended piston rod) of the drive

# Round cylinders DSNU/DSNUP/DSN/ESNU/ESN

Accessories

FESTO

## Dimensions

Download CAD data → [www.festo.com](http://www.festo.com)

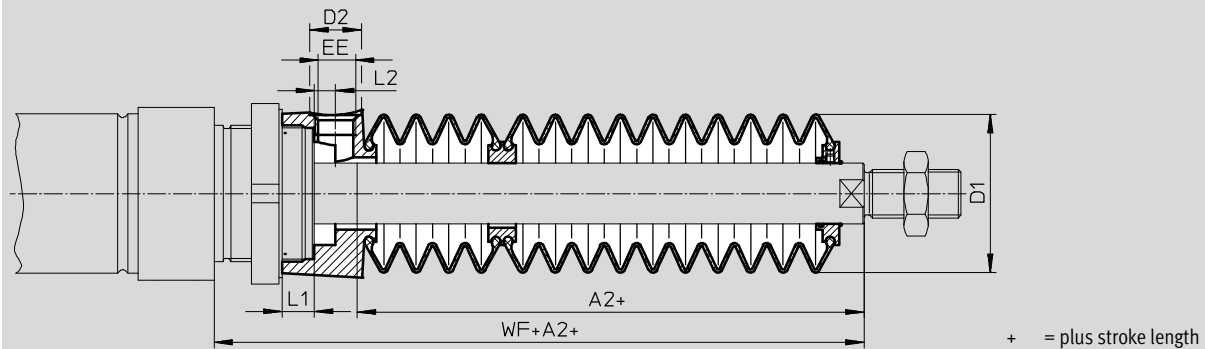

Ø Stroke [mm]	32							40						
	A2 <sup>1)</sup>	D1 max.	D2	EE	L1	L2	WF+A2	A2 <sup>1)</sup>	D1 max.	D2	EE	L1	L2	WF+A2
10 ... 50	30	38	14	G1/8	12.9	5.4	64	29	46	14	G1/8	8.1	5.4	68
51 ... 125	48						82	44						83
126 ... 175	63						97	57						96
176 ... 250	82						116	73						112
251 ... 300	97						131	87						126
301 ... 350	113						147	101						140
351 ... 375	115						149	102						141
376 ... 425	131						165	116						155
426 ... 475	147						181	131						170
476 ... 500	149						183	132						171

Ø Stroke [mm]	50/63						
	A2 <sup>1)</sup>	D1 max.	D2	EE	L1	L2	WF+A2
10 ... 50	30	57	17	G1/4	10.65	7	74/75
51 ... 125	48						92/93
126 ... 175	58						102/103
176 ... 250	77						121/122
251 ... 300	88						132/133
301 ... 350	99						143/144
351 ... 375	106						150/151
376 ... 425	117						161/162
426 ... 475	128						172/173
476 ... 500	135						179/180

1) The dimension corresponds to the K8 value (extended piston rod) of the drive

# Round cylinders DSNU/DSNUP/DSN/ESNU/ESN

Accessories

## Ordering data – Bellows kit

An extended piston rod (order code K8) is required when using a bellows kit  
 → Ordering data – Modular products.

The necessary dimensions for K8 as a function of piston diameter and cylinder stroke as well as the corresponding bellows kit are indicated in the table below:

### Order example:

Selected standard cylinder:  
 DSNU-25-320-PPV-A-MQ-...

The dimension for the corresponding K8 value (see table):  
 101 mm

Complete type code for standard cylinder:

DSNU-25-320-PPV-A-MQ-...-101K8

The corresponding bellows kit:

DADB-S1-25-S301-350

Cylinder data			Bellows kit		Cylinder data			Bellows kit	
∅	Stroke	Dimension for K8	Part No.	Type	∅	Stroke	Dimension for K8	Part No.	Type
[mm]	[mm]	[mm]			[mm]	[mm]	[mm]		
12	10 ... 50	23	553391	DADB-S1-12-S10-50	16	10 ... 50	23	553399	DADB-S1-16-S10-50
	51 ... 100	34	553393	DADB-S1-12-S51-100		51 ... 100	34	553401	DADB-S1-16-S51-100
	101 ... 150	48	553395	DADB-S1-12-S101-150		101 ... 150	48	553403	DADB-S1-16-S101-150
	151 ... 200	59	553397	DADB-S1-12-S151-200		151 ... 200	59	553405	DADB-S1-16-S151-200
20	10 ... 50	22	553407	DADB-S1-20-S10-50	25	10 ... 50	22	553421	DADB-S1-25-S10-50
	51 ... 100	34	553409	DADB-S1-20-S51-100		51 ... 100	34	553423	DADB-S1-25-S51-100
	101 ... 150	47	553411	DADB-S1-20-S101-150		101 ... 150	47	553425	DADB-S1-25-S101-150
	151 ... 200	60	553413	DADB-S1-20-S151-200		151 ... 200	60	553427	DADB-S1-25-S151-200
	201 ... 250	75	553415	DADB-S1-20-S201-250		201 ... 250	75	553429	DADB-S1-25-S201-250
	251 ... 300	86	553417	DADB-S1-20-S251-300		251 ... 300	86	553431	DADB-S1-25-S251-300
	301 ... 320	101	553419	DADB-S1-20-S301-350		301 ... 350	101	553433	DADB-S1-25-S301-350
				351 ... 400		112	553435	DADB-S1-25-S351-400	
				401 ... 450		127	553437	DADB-S1-25-S401-450	
				451 ... 500		138	553439	DADB-S1-25-S451-500	
32	10 ... 50	30	553441	DADB-S1-32-S10-50	40	10 ... 50	29	553461	DADB-S1-40-S10-50
	51 ... 125	48	553443	DADB-S1-32-S51-125		51 ... 125	44	553463	DADB-S1-40-S51-125
	126 ... 175	63	553445	DADB-S1-32-S126-175		126 ... 175	57	553465	DADB-S1-40-S126-175
	176 ... 250	82	553447	DADB-S1-32-S176-250		176 ... 250	73	553467	DADB-S1-40-S176-250
	251 ... 300	97	553449	DADB-S1-32-S251-300		251 ... 300	87	553469	DADB-S1-40-S251-300
	301 ... 350	113	553451	DADB-S1-32-S301-350		301 ... 350	101	553471	DADB-S1-40-S301-350
	351 ... 375	115	553453	DADB-S1-32-S351-375		351 ... 375	102	553473	DADB-S1-40-S351-375
	376 ... 425	131	553455	DADB-S1-32-S376-425		376 ... 425	116	553475	DADB-S1-40-S376-425
	426 ... 475	147	553457	DADB-S1-32-S426-475		426 ... 475	131	553477	DADB-S1-40-S426-475
	476 ... 500	149	553459	DADB-S1-32-S476-500		476 ... 500	132	553479	DADB-S1-40-S476-500
50	10 ... 50	30	553481	DADB-S1-50-S10-50	63	10 ... 50	30	553501	DADB-S1-63-S10-50
	51 ... 125	48	553483	DADB-S1-50-S51-125		51 ... 125	48	553503	DADB-S1-63-S51-125
	126 ... 175	58	553485	DADB-S1-50-S126-175		126 ... 175	58	553505	DADB-S1-63-S126-175
	176 ... 250	77	553487	DADB-S1-50-S176-250		176 ... 250	77	553507	DADB-S1-63-S176-250
	251 ... 300	88	553489	DADB-S1-50-S251-300		251 ... 300	88	553509	DADB-S1-63-S251-300
	301 ... 350	99	553491	DADB-S1-50-S301-350		301 ... 350	99	553511	DADB-S1-63-S301-350
	351 ... 375	106	553493	DADB-S1-50-S351-375		351 ... 375	106	553513	DADB-S1-63-S351-375
	376 ... 425	117	553495	DADB-S1-50-S376-425		376 ... 425	117	553515	DADB-S1-63-S376-425
	426 ... 475	128	553497	DADB-S1-50-S426-475		426 ... 475	128	553517	DADB-S1-63-S426-475
	476 ... 500	135	553499	DADB-S1-50-S476-500		476 ... 500	135	553519	DADB-S1-63-S476-500

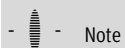



Note

Can only be used with piston ∅ 20 and 25 of the single-acting standard cylinder ESNU.



# Round cylinders DSNU/DSNUP/DSN/ESNU/ESN

Accessories

Ordering data – Proximity sensors, round design, magneto-resistive							Technical data → Internet: smto	
Assembly	Switching output	Electrical connection		Cable length [m]	Connection direction	Part No.	Type	
		Cable	Plug M8					
N/O contact								
	Via accessories	PNP	3-wire	–	2.5	In-line	152836	SMTO-4U-PS-K-LED-24
			–	3-pin	–	In-line	152742	SMTO-4U-PS-S-LED-24
	NPN	3-wire	–	2.5	In-line	152837	SMTO-4U-NS-K-LED-24	
		–	3-pin	–	In-line	152743	SMTO-4U-NS-S-LED-24	

Ordering data – Proximity sensors, round design, magnetic reed							Technical data → Internet: smeo	
Assembly	Electrical connection		Cable length [m]	Connection direction	Part No.	Type		
	Cable	Plug M8						
N/O contact								
	Via accessories	3-wire	–	2.5	In-line	36198	SMEO-4U-K-LED-24	
			5	In-line	175401	SMEO-4U-K5-LED-24		
		–	3-pin	–	In-line	151526	SMEO-4U-S-LED-24-B	

Ordering data – Proximity sensors, round design, magnetic reed, corrosion resistant							Technical data → Internet: crsmeo	
Assembly	Electrical connection		Cable length [m]	Connection direction	Part No.	Type		
	Cable	Plug M8						
N/O contact								
	Via accessories	3-wire	–	2.5	In-line	161775	CRSMEO-4-K-LED-24	



Ordering data – Mounting kits for proximity sensors SMEO/SMTO/CRSMEO							Technical data → Internet: smbr	
Designation	For Ø	Part No.	Type	Designation	For Ø	Part No.	Type	
Mounting kit SMBR				Mounting kit CRSMBR, corrosion resistant				
	8	19272	SMBR-8		8	–	–	
	10	19273	SMBR-10		10	–	–	
	12	19274	SMBR-12		12	164581	CRSMBR-12	
	16	19275	SMBR-16		16	164582	CRSMBR-16	
	20	19276	SMBR-20		20	164583	CRSMBR-20	
	25	19277	SMBR-25		25	164584	CRSMBR-25	
–				32	163888	CRSMBR-32		
				40	163889	CRSMBR-40		
				50	163890	CRSMBR-50		
				63	163891	CRSMBR-63		

# Round cylinders DSNU/DSNUP/DSN/ESNU/ESN

Accessories

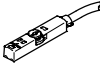
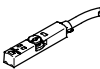
**FESTO**

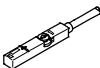
Ordering data – Proximity sensors for T-slot, magneto-resistive						Technical data → Internet: smt	
	Type of mounting	Switch output	Electrical connection	Cable length [m]	Part No.	Type	
<b>N/O contact</b>							
	Insertable in the slot from above, flush with cylinder profile, short design	PNP	Cable, 3-wire	2.5	<b>574335</b>	<b>SMT-8M-A-PS-24V-E-2,5-OE</b>	
			Plug M8x1, 3-pin	0.3	<b>574334</b>	<b>SMT-8M-A-PS-24V-E-0,3-M8D</b>	
			Plug M12x1, 3-pin	0.3	<b>574337</b>	<b>SMT-8M-A-PS-24V-E-0,3-M12</b>	
		NPN	Cable, 3-wire	2.5	<b>574338</b>	<b>SMT-8M-A-NS-24V-E-2,5-OE</b>	
			Plug M8x1, 3-pin	0.3	<b>574339</b>	<b>SMT-8M-A-NS-24V-E-0,3-M8D</b>	
<b>N/C contact</b>							
	Insertable in the slot from above, flush with cylinder profile, short design	PNP	Cable, 3-wire	7.5	<b>574340</b>	<b>SMT-8M-A-PO-24V-E-7,5-OE</b>	

Ordering data – Proximity sensors for T-slot, magnetic reed						Technical data → Internet: sme		
	Type of mounting	Switching output	Electrical connection	Cable length [m]	Part No.	Type		
<b>N/O contact</b>								
	Insertable in the slot from above, flush with the cylinder profile	Contacting	Cable, 3-wire	2.5	<b>543862</b>	<b>SME-8M-DS-24V-K-2,5-OE</b>		
				5.0	<b>543863</b>	<b>SME-8M-DS-24V-K-5,0-OE</b>		
			Plug M8x1, 3-pin	Cable, 2-wire	2.5	<b>543872</b>	<b>SME-8M-ZS-24V-K-2,5-OE</b>	
				0.3	<b>543861</b>	<b>SME-8M-DS-24V-K-0,3-M8D</b>		
	Insertable in the slot lengthwise, flush with the cylinder profile	Contacting	Cable, 3-wire	2.5	<b>150855</b>	<b>SME-8-K-LED-24</b>		
				0.3	<b>150857</b>	<b>SME-8-S-LED-24</b>		
<b>N/C contact</b>								
	Insertable in the slot lengthwise, flush with the cylinder profile	Contacting	Cable, 3-wire	7.5	<b>160251</b>	<b>SME-8-O-K-LED-24</b>		



Ordering data – Mounting kits for proximity sensors SME/SMT-8					Technical data → Internet: smbr	
Designation	For Ø				Part No.	Type
<b>Mounting kit SMBR-8</b>						
	8				<b>175091</b>	<b>SMBR-8-8</b>
	10				<b>175092</b>	<b>SMBR-8-10</b>
	12				<b>175093</b>	<b>SMBR-8-12</b>
	16				<b>175094</b>	<b>SMBR-8-16</b>
	20				<b>175095</b>	<b>SMBR-8-20</b>
	25				<b>175096</b>	<b>SMBR-8-25</b>
	32				<b>175097</b>	<b>SMBR-8-32</b>
	40				<b>175098</b>	<b>SMBR-8-40</b>
	50				<b>175099</b>	<b>SMBR-8-50</b>
63				<b>175100</b>	<b>SMBR-8-63</b>	

# Round cylinders DSNU/DSNUP/DSN/ESNU/ESN



Accessories

FESTO

Ordering data – Proximity sensors for slot type 10 (C-slot), magneto-resistive						Technical data → Internet: smt
	Type of mounting	Switching output	Electrical connection, connection direction	Cable length [m]	Part No.	Type
N/O contact						
	Insertable in the slot from above	PNP	Cable, 3-wire, in-line	2.5	551373	SMT-10M-PS-24V-E-2,5-L-OE
			Plug M8x1, 3-pin, in-line	0.3	551375	SMT-10M-PS-24V-E-0,3-L-M8D
			Plug M8x1, 3-pin, angled	0.3	551376	SMT-10M-PS-24V-E-0,3-Q-M8D

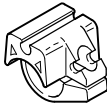
Ordering data – Proximity sensors for C-slot, magnetic reed						Technical data → Internet: sme
	Type of mounting	Switching output	Electrical connection, connection direction	Cable length [m]	Part No.	Type
N/O contact						
	Insertable in the slot from above	Contacting	Plug M8x1, 3-pin, in-line	0.3	551367	SME-10M-DS-24V-E-0,3-L-M8D
			Cable, 3-wire, in-line	2.5	551365	SME-10M-DS-24V-E-2,5-L-OE
			Cable, 2-wire, in-line	2.5	551369	SME-10M-ZS-24V-E-2,5-L-OE
	Insertable in slot lengthwise	Contacting	Plug M8x1, 3-pin, in-line	0.3	173212	SME-10-SL-LED-24
			Cable, 3-wire, in-line	2.5	173210	SME-10-KL-LED-24

Ordering data – Mounting kits for proximity sensors SME/SMT-10					Technical data → Internet: smbr
Designation	For Ø		Part No.	Type	
Mounting kit SMBR-10					
	8		175101	SMBR-10-8	
	10		173227	SMBR-10-10	
	12		175102	SMBR-10-12	
	16		173228	SMBR-10-16	
	20		175103	SMBR-10-20	
	25		175104	SMBR-10-25	
	32		175105	SMBR-10-32	
	40		175106	SMBR-10-40	
	50		175107	SMBR-10-50	
	63		175108	SMBR-10-63	



Ordering data – Connecting cables					Technical data → Internet: nebu
	Electrical connection, left	Electrical connection, right	Cable length [m]	Part No.	Type
	Straight socket, M8x1, 3-pin	Cable, open end, 3-wire	2.5	541333	NEBU-M8G3-K-2.5-LE3
			5	541334	NEBU-M8G3-K-5-LE3
	Straight socket, M12x1, 5-pin	Cable, open end, 3-wire	2.5	541363	NEBU-M12G5-K-2.5-LE3
			5	541364	NEBU-M12G5-K-5-LE3
	Angled socket, M8x1, 3-pin	Cable, open end, 3-wire	2.5	541338	NEBU-M8W3-K-2.5-LE3
			5	541341	NEBU-M8W3-K-5-LE3
	Angled socket, M12x1, 5-pin	Cable, open end, 3-wire	2.5	541367	NEBU-M12W5-K-2.5-LE3
			5	541370	NEBU-M12W5-K-5-LE3



# Round cylinders DSNU/DSNUP/DSN/ESNU/ESN

Accessories

**FESTO**

Ordering data – One-way flow control valves				Technical data → Internet: grl			
	Port		Material	Part No.	Type		
	Thread	For tubing O.D.					
<b>For exhaust air</b>							
	M5	3	Metal design	<b>193137</b>	<b>GRLA-M5-QS-3-D</b>		
		4		<b>193138</b>	<b>GRLA-M5-QS-4-D</b>		
		6		<b>193139</b>	<b>GRLA-M5-QS-6-D</b>		
	G1/8	3		<b>193142</b>	<b>GRLA-1/8-QS-4-D</b>		
		4		<b>193143</b>	<b>GRLA-1/8-QS-4-D</b>		
		6		<b>193144</b>	<b>GRLA-1/8-QS-6-D</b>		
		8		<b>193145</b>	<b>GRLA-1/8-QS-8-D</b>		
	G1/4	6		<b>193146</b>	<b>GRLA-1/4-QS-6-D</b>		
		8		<b>193147</b>	<b>GRLA-1/4-QS-8-D</b>		
		10		<b>193148</b>	<b>GRLA-1/4-QS-10-D</b>		
		6		<b>193149</b>	<b>GRLA-3/8-QS-6-D</b>		
	G3/8	8		<b>193150</b>	<b>GRLA-3/8-QS-8-D</b>		
		10		<b>193151</b>	<b>GRLA-3/8-QS-10-D</b>		
	<b>For supply air</b>						
		G1/8		3	Metal design	<b>193153</b>	<b>GRLZ-M5-QS-3-D</b>
4			<b>193154</b>	<b>GRLZ-M5-QS-4-D</b>			
6			<b>193155</b>	<b>GRLZ-M5-QS-6-D</b>			
3			<b>193156</b>	<b>GRLZ-1/8-QS-3-D</b>			
4			<b>193157</b>	<b>GRLZ-1/8-QS-4-D</b>			
6			<b>193158</b>	<b>GRLZ-1/8-QS-6-D</b>			
8			<b>193159</b>	<b>GRLZ-1/8-QS-8-D</b>			

Ordering data – One-way flow control valves, corrosion resistant				Technical data → Internet: crgla	
	Port		Material	Part No.	Type
	Thread	For push-in fitting			
<b>For exhaust air</b>					
	M5	CRQS/CRQSL/CRQST	Electrolytically polished stainless steel casting	<b>161403</b>	<b>CRGRLA-M5-B</b>
	G1/8			<b>161404</b>	<b>CRGRLA-1/8-B</b>
	G1/4			<b>161405</b>	<b>CRGRLA-1/4-B</b>
	G3/8			<b>161406</b>	<b>CRGRLA-3/8-B</b>

-  - Note

Only push-in fittings or one-way flow control valves with cylindrical connecting thread (M or G thread) may be used for the compressed air ports in conjunction with the DSNUP.