

One-way flow control valves



# One-way flow control valves

Key features



## Function

Flow control or one-way flow control valves regulate the piston speed of pneumatic drives during advance and return strokes. This is done through suitable restriction of the flow rate of compressed air in exhaust air or supply air direction. With the one-way

flow control valve GRLA or GRLZ, the flow control function works in one direction only (exhaust air or supply air); the non-return function works in the opposite direction. With the flow control valve GRLO, the flow control function is active in both directions.

The flow control function creates an adjustable annular gap inside the valve. This gap can be increased or decreased by turning the knurled screw or slotted head screw. The required restriction can be set with the help of this adjustment component.

**Note**  
The documentation for the flow control valves can be found at [www.festo.com/catalogue](http://www.festo.com/catalogue)

## General information

### Standard nominal flow rate $q_{nN}$

The standard nominal flow rate  $q_{nN}$  is the flow rate based on standard conditions at an operating pressure of  $p_1 = 6$  bar and an output pressure of  $p_2 = 5$  bar, measured at room temperature  $t = 20$  °C.

### Exhaust air one-way flow control function

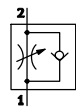

### Supply air one-way flow control function

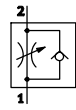

### Standard flow rate $q_n$

The standard flow rate is measured at an operating pressure of  $p_1 = 6$  bar and an output pressure with respect to atmospheric pressure ( $p_2 = 0$  bar).

### Flow control function in both directions



### Flow measurement circuit

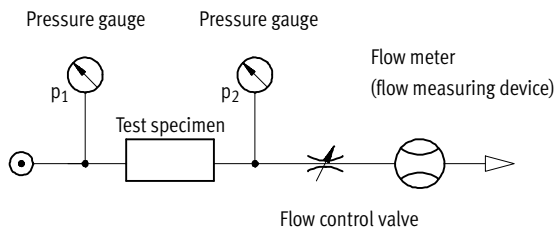

$p_1$  Operating pressure  
 $p_2$  Output pressure

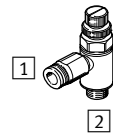

- 1 Supply port (pneumatic connection 1)
- 2 Working line (pneumatic connection 2)

# One-way flow control valves

Key features

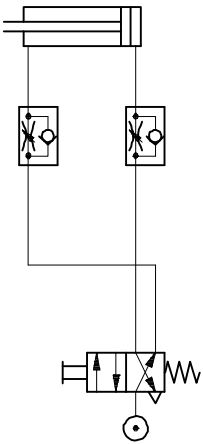
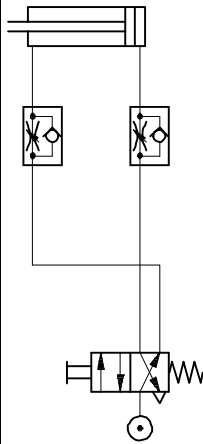
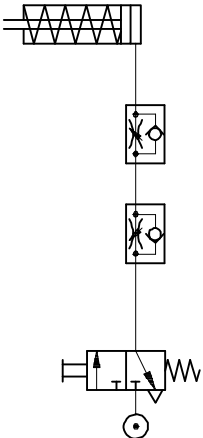
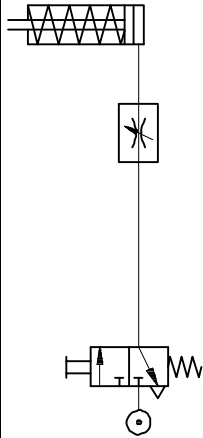
Flow control functions and range of applications			
Application		Description	
<b>Double-acting cylinder with one-way flow control valve</b>			
Exhaust air one-way flow control function		Supply air one-way flow control function	
	<p>Speed adjustment through exhaust air flow control. Uncontrolled supply air and controlled exhaust air move the piston between air cushions (improves motion, even with load changes).</p>		<p>Adjustable speed during advance and return strokes. The flow rate is identical in both directions.</p>
<b>Single-acting cylinder with one-way flow control valve</b>		<b>Single-acting cylinder with flow control valve</b>	
Exhaust air and supply air one-way flow control function		Flow control function in both directions	
	<p>Adjustable speed during advance and return strokes. The flow rate can be adjusted differently for both directions.</p>		<p>Speed adjustment through flow control on both sides is often applied in the case of single-acting or small cylinders. The benefit of this application lies in its simplicity.</p>

## Application examples

Mini slide SLT with one-way flow control valve, standard

Flat cylinder DZF with one-way flow control valve, mini



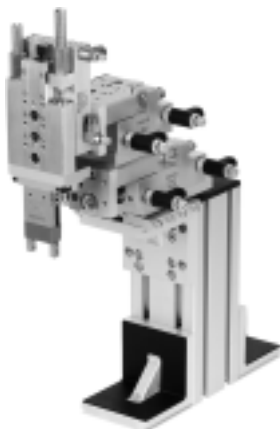







Multimount cylinder DMM with one-way flow control valve, mini



# One-way flow control valves

Product range overview

FESTO

Version	Valve function	Version	Type	Connection direction	Pneumatic connection 1	Pneumatic connection 2	q <sub>n</sub> N <sup>1)</sup> [l/min]	Adjustment component	→ Page/ Internet					
<b>Standard</b>	<b>Metal</b>													
	Exhaust air one-way flow control function		GRLA	Elbow outlet	QS-3, QS-4, QS-6, QS-8, QS-10, QS-12	M5, G <sup>1</sup> / <sub>8</sub> , G <sup>1</sup> / <sub>4</sub> , G <sup>3</sup> / <sub>8</sub> , G <sup>1</sup> / <sub>2</sub>	100 ... 1,580	Slotted head screw	8					
								Knurled screw						
					M5, G <sup>1</sup> / <sub>8</sub> , G <sup>1</sup> / <sub>4</sub> , G <sup>3</sup> / <sub>8</sub> , G <sup>1</sup> / <sub>2</sub> , G <sup>3</sup> / <sub>4</sub>	M5, G <sup>1</sup> / <sub>8</sub> , G <sup>1</sup> / <sub>4</sub> , G <sup>3</sup> / <sub>8</sub> , G <sup>1</sup> / <sub>2</sub> , G <sup>3</sup> / <sub>4</sub>	95 ... 4,320	Slotted head screw	12					
								Knurled screw						
		PK-3, PK-4, PK-6	M5, G <sup>1</sup> / <sub>8</sub> , G <sup>1</sup> / <sub>4</sub>	83 ... 540	Slotted head screw	12								
					Knurled screw									
	Supply air one-way flow control function		GRLZ	Elbow outlet	QS-3, QS-4, QS-6, QS-8	M5, G <sup>1</sup> / <sub>8</sub>	100 ... 215	Slotted head screw	8					
										M5, G <sup>1</sup> / <sub>8</sub> , G <sup>1</sup> / <sub>4</sub>	M5, G <sup>1</sup> / <sub>8</sub> , G <sup>1</sup> / <sub>4</sub>	95 ... 610	Slotted head screw	12
													Knurled screw	
										PK-3, PK-4, PK-6	M5, G <sup>1</sup> / <sub>8</sub> , G <sup>1</sup> / <sub>4</sub>	83 ... 540	Slotted head screw	12
	Knurled screw													
		VFOC-S	Elbow outlet	QS-4, QS-6	Push-in sleeve <sup>2)</sup> QS-4, QS-6	100 ... 270	Slotted head screw	20						
							Knurled screw							
<b>Nickel-plated metal</b>														
Exhaust air one-way flow control function		VFOH-LE	Elbow outlet	QS-4, QS-6, QS-8, QS-10	G <sup>1</sup> / <sub>8</sub> , G <sup>1</sup> / <sub>4</sub>	180 ... 530	External hex	22						
<b>Polymer</b>														
Exhaust air one-way flow control function		GRLA	Elbow outlet	QS-6, QS-8	G <sup>1</sup> / <sub>8</sub> , G <sup>1</sup> / <sub>4</sub> , G <sup>3</sup> / <sub>8</sub>	520 ... 650	Knurled screw	24						
<b>Flat</b>														
<b>Polymer</b>														
Exhaust air one-way flow control function		VFOF	Elbow outlet	QS-6, QS-8	G <sup>1</sup> / <sub>8</sub> , G <sup>1</sup> / <sub>4</sub>	250 ... 650	Internal hex	vfof						









1) Standard nominal flow rate in direction of flow control.

2) Only suitable for push-in connector QS.

# One-way flow control valves

Product range overview

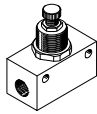
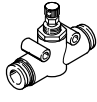
FESTO

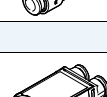
Version	Valve function	Version	Type	Connection direction	Pneumatic connection 1	Pneumatic connection 2	qnN <sup>1)</sup> [l/min]	Adjustment component	→ Page/ Internet
<b>Mini</b>	<b>Metal</b> Exhaust air one-way flow control function		GRLA	Elbow outlet	QS-3, QS-4	M3, M5	40 ... 41	Slotted head screw	26
					M3	M3	0 ... 18	Slotted head screw	29
			GRGA	Parallel outlet	QS-3	M3	0 ... 41	Slotted head screw	26
	Supply air one-way flow control function		GRLZ	Elbow outlet	QS-3, QS-4	M3, M5	41 ... 48	Slotted head screw	26
					M3	M3	0 ... 18	Slotted head screw	29
			GRGZ	Parallel outlet	QS-3	M3	0 ... 41	Slotted head screw	26
<b>In-line installation</b>	One-way flow control function		GR/GRA	Inline	M3, M5, G <sup>1</sup> / <sub>8</sub> , G <sup>1</sup> / <sub>4</sub> , G <sup>3</sup> / <sub>8</sub> , G <sup>1</sup> / <sub>2</sub> , G <sup>3</sup> / <sub>4</sub>	M3, M5, G <sup>1</sup> / <sub>8</sub> , G <sup>1</sup> / <sub>4</sub> , G <sup>3</sup> / <sub>8</sub> , G <sup>1</sup> / <sub>2</sub> , G <sup>3</sup> / <sub>4</sub>	29.5 ... 3,300	Knurled screw	gr
			GR	Inline	QS-3, QS-4, QS-6, QS-8	QS-3, QS-4, QS-6, QS-8	40 ... 250	Knurled screw	gr
<b>Corrosion-resistant</b>	Exhaust air one-way flow control function		CRGRLA	Elbow outlet	M5, G <sup>1</sup> / <sub>8</sub> , G <sup>1</sup> / <sub>4</sub> , G <sup>3</sup> / <sub>8</sub> , G <sup>1</sup> / <sub>2</sub>	M5, G <sup>1</sup> / <sub>8</sub> , G <sup>1</sup> / <sub>4</sub> , G <sup>3</sup> / <sub>8</sub> , G <sup>1</sup> / <sub>2</sub>	95 ... 2,100	Slotted head screw	31
<b>Function combination</b>	Exhaust air one-way flow control function		GRXA	Elbow outlet	QS-4, QS-6, QS-8	G <sup>1</sup> / <sub>8</sub> , G <sup>1</sup> / <sub>4</sub>	130 ... 280	Slotted head screw	34
			VFOF	Elbow outlet	QS-6, QS-8	G <sup>1</sup> / <sub>8</sub> , G <sup>1</sup> / <sub>4</sub>	240 ... 590	Internal hex	vfof

1) Standard nominal flow rate in direction of flow control.

# One-way flow control valves

Type codes

FESTO

GRLA/GRLSA/GRGA/CRGRLA/GRLZ/GRGZ

GRLA - 1/8 - QS - 6 - - - D

Type	
Exhaust air one-way flow control function	
GRLA	One-way flow control valve, elbow outlet
GRLSA	One-way flow control valve, elbow outlet with rotary knob
GRGA	One-way flow control valve, parallel outlet
CRGRLA	One-way flow control valve, elbow outlet, corrosion-resistant
GRXA-HG	One-way flow control valve, function combination
Supply air one-way flow control function	
GRLZ	One-way flow control valve, elbow outlet
GRGZ	One-way flow control valve, parallel outlet
Pneumatic connection 2	
M3, M5, 1/8, 1/4, 3/8, 1/2, 3/4	Male thread
Pneumatic connection 1	
Connection type	
-	Female thread (connection size as for connection 2)
QS	Push-in connector QS
PK	Barbed connector
Tubing O.D. or tubing I.D.	
3, 4, 6, 8, 10, 12	Tubing O.D. with push-in connector QS
3, 4, 6	Tubing I.D. with barbed connector PK
Adjustment component	
-	Slotted head screw
RS	Knurled screw
Flow rate characteristic	
LF	Low flow
MF	Medium flow
Generation	
B	B series
C	C series
D	D series

# One-way flow control valves

Type codes

## VOFC

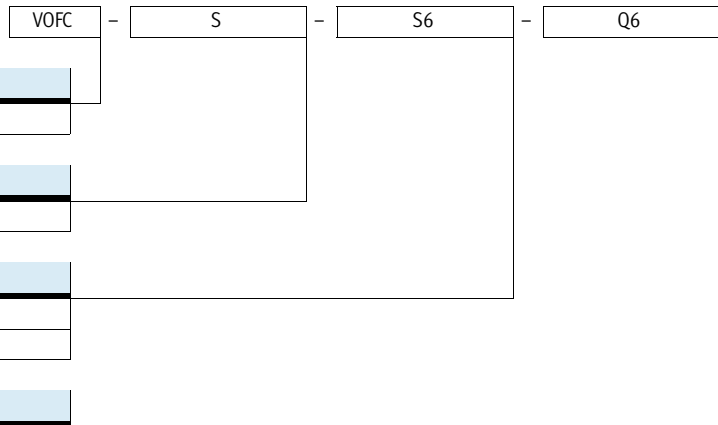

Type	
VOFC	One-way flow control valve, elbow outlet

Valve function	
S	Supply air one-way flow control function

Pneumatic connection 2	
S4	Push-in sleeve QS-4
S6	Push-in sleeve QS-6

Pneumatic connection 1	
Q4	Push-in connector QS-4
Q6	Push-in connector QS-6

## VOFH-LE

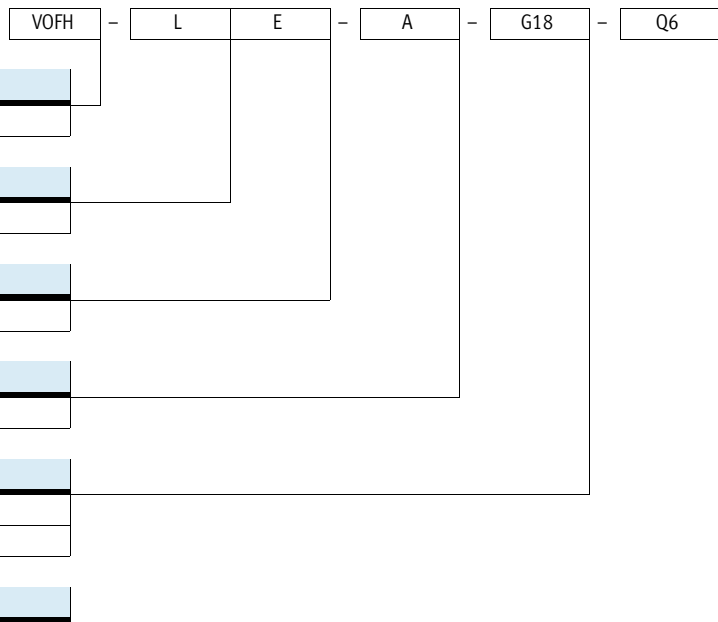

Type	
VOFH	One-way flow control valve

Design	
L	L-shaped outlet

Valve function	
E	Exhaust air one-way flow control function

Adjusting element	
A	External hex

Pneumatic connection 2	
G18	Thread G $\frac{1}{8}$
G14	Thread G $\frac{1}{4}$

Pneumatic connection 1	
Q4	Push-in connector QS-4
Q6	Push-in connector QS-6
Q8	Push-in connector QS-8
Q10	Push-in connector QS-10

# One-way flow control valves GRLA/GRLZ, standard

Technical data – Push-in connector QS, metal



One-way flow control function

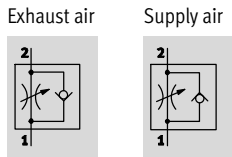

- - Flow rate  
100 ... 1,580 l/min
- - Temperature range  
-10 ... +60 °C
- - Operating pressure  
0.2 ... 10 bar

- Can be swivelled 360° around the screw-in axis after mounting

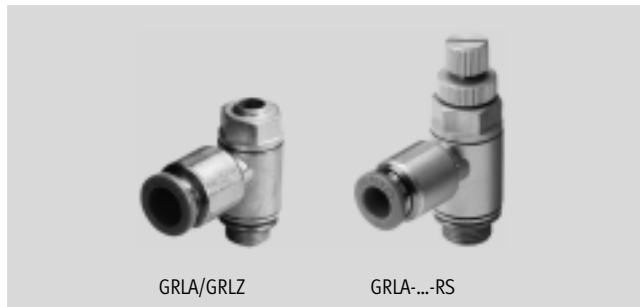

General technical data – GRLA						
Valve function	Exhaust air one-way flow control function					
Pneumatic connection 2	M5	G1/8	G1/4	G3/8	G1/2	
Pneumatic connection 1	QS-3, QS-4, QS-6	QS-3, QS-4, QS-6, QS-8	QS-6, QS-8, QS-10	QS-6, QS-8, QS-10	QS-12	
Adjustment component	Slotted head screw Knurled screw					
Type of mounting	Screw-in, via male thread					
Mounting position	Any					
Nominal tightening torque [Nm]	0.8 ±10%	3 ±10%	5 ±10%	10 ±10%	15 ±10%	

General technical data – GRLZ		
Valve function	Supply air one-way flow control function	
Pneumatic connection 2	M5	G1/8
Pneumatic connection 1	QS-3, QS-4, QS-6	QS-3, QS-4, QS-6, QS-8
Adjustment component	Slotted head screw	
Type of mounting	Screw-in, via male thread	
Mounting position	Any	
Nominal tightening torque [Nm]	0.8 ±10%	3 ±10%

Operating and environmental conditions	
Operating pressure complete	[bar] 0.2 ... 10
temperature range	
Operating medium	Compressed air in accordance with ISO 8573-1:2010 [7:4:4]
Note on operating/pilot medium	Operation with lubricated medium possible (in which case lubricated operation will always be required)
Ambient temperature	[°C] -10 ... +60
Temperature of medium	[°C] -10 ... +60
Storage temperature	[°C] -10 ... +40
Certification	Germanischer Lloyd

**Standard nominal flow rate  $q_{nN}$  at 6 → 5 bar as a function of turns of the adjusting screw  $n$**   
GRLA/GRLZ-M5

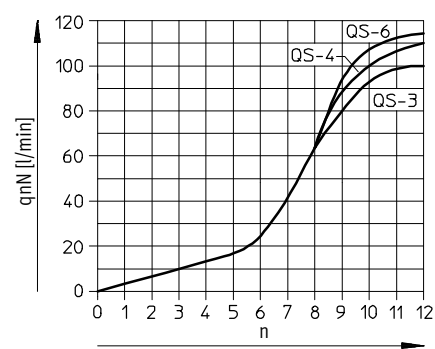

**Standard flow rate  $q_n$  at 6 → 0 bar as a function of turns of the adjusting screw  $n$**   
GRLA/GRLZ-M5

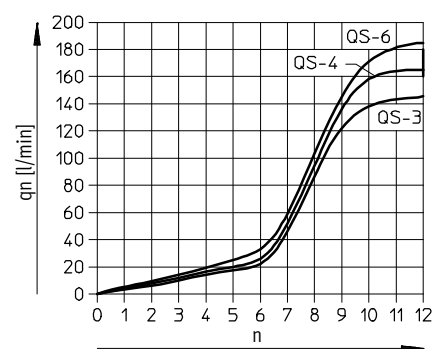



# One-way flow control valves GRLA/GRLZ, standard

Technical data – Push-in connector QS, metal

Standard nominal flow rate  $q_{nN}$  at 6  $\rightarrow$  5 bar  
as a function of turns of the adjusting screw n

GRLA/GRLZ-1/8

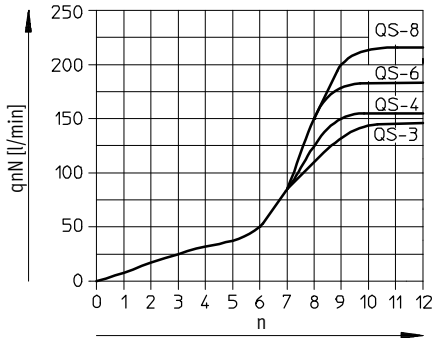

Standard flow rate  $q_n$  at 6  $\rightarrow$  0 bar  
as a function of turns of the adjusting screw n

GRLA/GRLZ-1/8

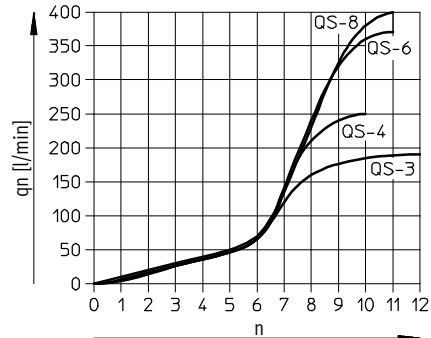

GRLA-1/8...-MF/GRLA-1/4

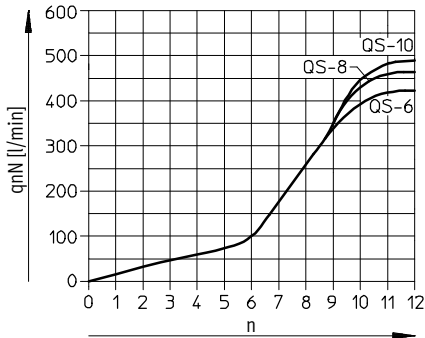

GRLA-1/8...-MF/GRLA-1/4

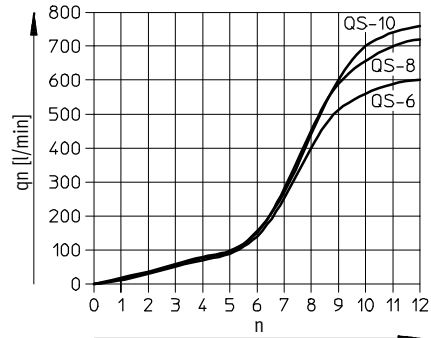

GRLA-3/8

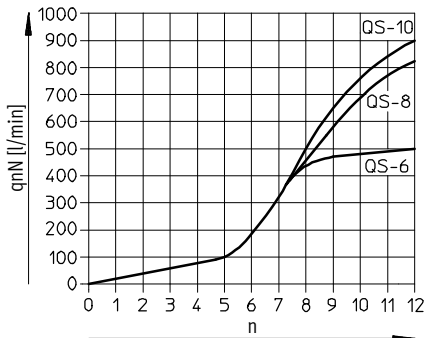

GRLA-3/8

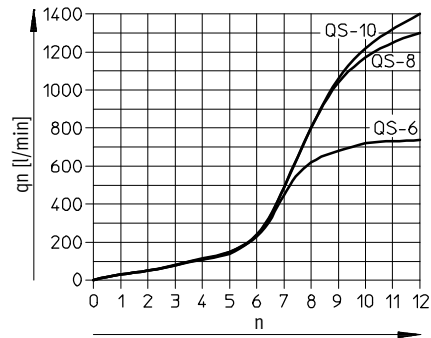

GRLA-1/2

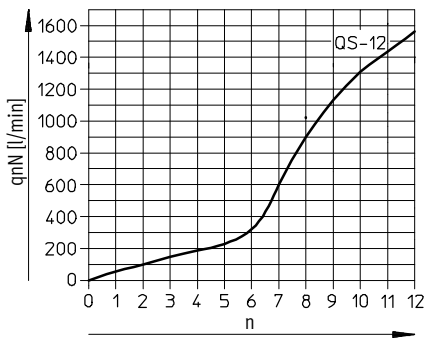

GRLA-1/2

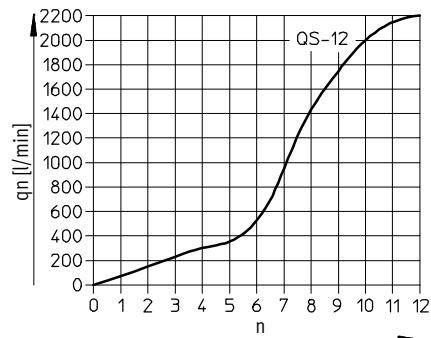

# One-way flow control valves GRLA/GRLZ, standard

Technical data – Push-in connector QS, metal

## Materials

Sectional view

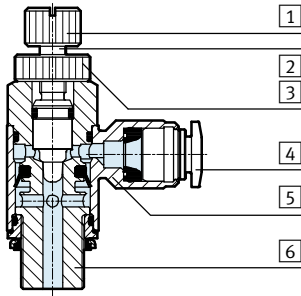

### One-way flow control valve

1	Knurled head (only GRLA...-RS)	Anodised wrought aluminium alloy
2	Adjusting screw	Brass
3	Hollow bolt (only GRLA...-RS)	Anodised wrought aluminium alloy
4	Releasing ring	POM
5	Swivel connection	Die-cast zinc, chromed
6	Threaded plug	Wrought aluminium alloy GRLA/GRLZ-M5: Brass
-	Seals	NBR
Note on materials		RoHS-compliant

## Dimensions

Download CAD data → [www.festo.com](http://www.festo.com)

Slotted head screw

Knurled screw

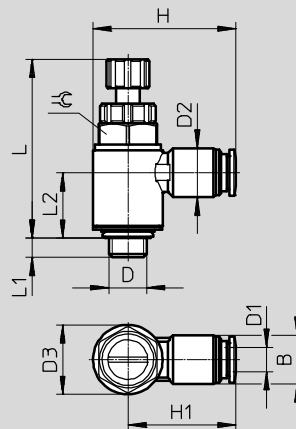
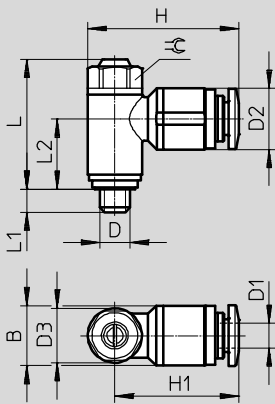



Type	Connection D	Tubing O.D. D1	B	D2 ∅	D3 ∅	H	H1	Lmax.		L1	L2	⌀C
								Slotted head screw	Knurled screw			
GRL...-M5	M5	3	-	8.2 +0.15	8.9 ±0.07	22.4	18	20.45	30.35	3.9 +0.1/-0.45	10.7	8
		4	9.8 ±0.2	10.0 ±0.2		24.7	20.3					
		6	-	12.0 ±0.2		26.5	22					
GRL...-1/8	G1/8	3	-	10.2 ±0.2	13.8 ±0.07	31.9	25	26.7	40.2	5.05 +0.15/-0.3	14.2	12
		4		10.2 ±0.2		29.4	22.5					
		6		12.5 ±0.2		32.6	25.7					
GRLA-1/8-...-MF	G1/8	6	-	12.5 ±0.2	17.8 ±0.15	36.6	27.7	31.3	-	5.05 +0.15/-0.3	17	15
		8		14.5 ±0.2		39.6	30.7					
GRLA-1/4	G1/4	6	-	12.5 ±0.2	17.8 ±0.15	36.6	27.7	31.5	48.3	5.9 +0.17/-0.25	17.2	15
		8		14.5 ±0.2		39.6	30.7					
		10		17.5 ±0.2		42.0	33.1					
GRLA-3/8	G3/8	6	-	12.5 ±0.2	22.4 ±0.15	39.8	28.6	35.25	54.55	6.9 +0.15/-0.3	19.55	19
		8		14.5 ±0.2		44.1	32.9					
		10		17.5 ±0.2		46.7	35.5					
GRLA-1/2	G1/2	12	-	20.5 ±0.15	27.8 ±0.15	55.3	41.4	42.05	65.45	8.35 +0.15/-0.3	22.75	24

# One-way flow control valves GRLA/GRLZ, standard

FESTO

Technical data – Push-in connector QS, metal

Ordering data – Exhaust air one-way flow control function									
Pneumatic connection		Standard nominal flow rate q <sub>N</sub> at 6 $\rightarrow$ 5 bar		Standard flow rate q <sub>n</sub> at 6 $\rightarrow$ 0 bar		Weight [g]	Part No.	Type	
		in direction of flow control	in non-return direction	in direction of flow control	in non-return direction				
2	1	[l/min]	[l/min]	[l/min]	[l/min]				
Slotted head screw									
	M5	QS-3	100	60 ... 100	145	150 ... 170	13	193137	GRLA-M5-QS-3-D
		QS-4	110	65 ... 110	165	140 ... 160		193138	GRLA-M5-QS-4-D
		QS-6	115	70 ... 110	185	145 ... 170		193139	GRLA-M5-QS-6-D
	G $\frac{1}{8}$	QS-3	130	100 ... 130	180	200 ... 220	22	193142	GRLA- $\frac{1}{8}$ -QS-3-D
		QS-4	160	120 ... 190	250	270 ... 300		193143	GRLA- $\frac{1}{8}$ -QS-4-D
		QS-6	185	160 ... 240	370	330 ... 390		193144	GRLA- $\frac{1}{8}$ -QS-6-D
		QS-8	400	290 ... 420	600	570 ... 680	32	537075	GRLA- $\frac{1}{8}$ -QS-6-MF-D
			215	175 ... 250	400	330 ... 410	22	193145	GRLA- $\frac{1}{8}$ -QS-8-D
	475	325 ... 500	720	610 ... 760	32	537076	GRLA- $\frac{1}{8}$ -QS-8-MF-D		
	G $\frac{1}{4}$	QS-6	400	290 ... 420	600	570 ... 680	42	193146	GRLA- $\frac{1}{4}$ -QS-6-D
		QS-8	475	325 ... 500	720	610 ... 760		193147	GRLA- $\frac{1}{4}$ -QS-8-D
		QS-10	480	345 ... 500	760	630 ... 790		193148	GRLA- $\frac{1}{4}$ -QS-10-D
	G $\frac{3}{8}$	QS-6	495	320 ... 495	740	840 ... 890	60	193149	GRLA- $\frac{3}{8}$ -QS-6-D
		QS-8	820	450 ... 850	1,300	1,080 ... 1,420		193150	GRLA- $\frac{3}{8}$ -QS-8-D
		QS-10	900	540 ... 975	1,400	1,160 ... 1,620		193151	GRLA- $\frac{3}{8}$ -QS-10-D
G $\frac{1}{2}$	QS-12	1,580	925 ... 1,605	2,220	1,910 ... 2,500	106	193152	GRLA- $\frac{1}{2}$ -QS-12-D	
Knurled screw									
	M5	QS-3	100	60 ... 100	145	150 ... 170	14	197576	GRLA-M5-QS-3-RS-D
		QS-4	110	65 ... 110	165	140 ... 160		197577	GRLA-M5-QS-4-RS-D
		QS-6	115	70 ... 110	185	145 ... 170		197578	GRLA-M5-QS-6-RS-D
	G $\frac{1}{8}$	QS-3	130	100 ... 130	180	200 ... 220	23	197579	GRLA- $\frac{1}{8}$ -QS-3-RS-D
		QS-4	160	120 ... 190	250	270 ... 300		197580	GRLA- $\frac{1}{8}$ -QS-4-RS-D
		QS-6	185	160 ... 240	370	330 ... 390		197581	GRLA- $\frac{1}{8}$ -QS-6-RS-D
		QS-8	215	175 ... 250	400	330 ... 410	24	534337	GRLA- $\frac{1}{8}$ -QS-8-RS-D
	G $\frac{1}{4}$	QS-6	400	290 ... 420	600	570 ... 680	50	534338	GRLA- $\frac{1}{4}$ -QS-6-RS-D
		QS-8	475	325 ... 500	720	610 ... 760		534339	GRLA- $\frac{1}{4}$ -QS-8-RS-D
		QS-10	480	345 ... 500	760	630 ... 790		534340	GRLA- $\frac{1}{4}$ -QS-10-RS-D
	G $\frac{3}{8}$	QS-6	495	320 ... 495	740	840 ... 890	72	534341	GRLA- $\frac{3}{8}$ -QS-6-RS-D
		QS-8	820	450 ... 850	1,300	1,080 ... 1,420		534342	GRLA- $\frac{3}{8}$ -QS-8-RS-D
		QS-10	900	540 ... 975	1,400	1,160 ... 1,620		534343	GRLA- $\frac{3}{8}$ -QS-10-RS-D
	G $\frac{1}{2}$	QS-12	1,580	925 ... 1,605	2,220	1,910 ... 2,500	124	534344	GRLA- $\frac{1}{2}$ -QS-12-RS-D

Ordering data – Supply air one-way flow control function									
Pneumatic connection		Standard nominal flow rate q <sub>N</sub> at 6 $\rightarrow$ 5 bar		Standard flow rate q <sub>n</sub> at 6 $\rightarrow$ 0 bar		Weight [g]	Part No.	Type	
		in direction of flow control	in non-return direction	in direction of flow control	in non-return direction				
2	1	[l/min]	[l/min]	[l/min]	[l/min]				
Slotted head screw									
	M5	QS-3	100	60 ... 100	135	130 ... 160	13	193153	GRLZ-M5-QS-3-D
		QS-4	110	65 ... 110	160	150 ... 180		193154	GRLZ-M5-QS-4-D
		QS-6	115	70 ... 110	170	160 ... 200		193155	GRLZ-M5-QS-6-D
	G $\frac{1}{8}$	QS-3	130	100 ... 130	200	180 ... 200	22	193156	GRLZ- $\frac{1}{8}$ -QS-3-D
		QS-4	160	120 ... 190	300	260 ... 290		193157	GRLZ- $\frac{1}{8}$ -QS-4-D
		QS-6	185	160 ... 240	340	390 ... 460		193158	GRLZ- $\frac{1}{8}$ -QS-6-D
		QS-8	215	175 ... 250	370	390 ... 470		193159	GRLZ- $\frac{1}{8}$ -QS-8-D

# One-way flow control valves GRLA/GRLZ, standard

FESTO

Technical data – Female thread/barbed connector, metal

One-way flow control function

Exhaust air

Supply air

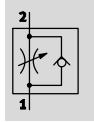
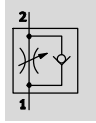

- Flow rate  
83 ... 4,320 l/min
- Temperature range  
-10 ... +60 °C
- Operating pressure  
0.2 ... 10 bar



## General technical data – GRLA

Valve function	Exhaust air one-way flow control function								
Connection type	Female thread						Barbed connector		
Pneumatic connection 2	M5	G1/8	G1/4	G3/8	G1/2	G3/4	M5	G1/8	G1/4
Pneumatic connection 1	M5 <sup>1)</sup>	G1/8 <sup>1)</sup>	G1/4 <sup>1)</sup>	G3/8 <sup>1)</sup>	G1/2 <sup>1)</sup>	G3/4 <sup>1)</sup>	PK-3, PK-4	PK-3, PK-4, PK-6	PK-4, PK-6
Adjustment component	Slotted head screw								
	Knurled screw			-					
Type of mounting	Screw-in								
Mounting position	Any								
Max. tightening torque [Nm]	1.5	6	11	20	40	60	1.5	6	11

1) - - Note: This product conforms to ISO 1179-1 and ISO 228-1.

## General technical data – GRLZ

Valve function	Supply air one-way flow control function								
Connection type	Female thread						Barbed connector		
Pneumatic connection 2	M5	G1/8	G1/4				M5	G1/8	G1/4
Pneumatic connection 1	M5 <sup>1)</sup>	G1/8 <sup>1)</sup>	G1/4 <sup>1)</sup>				PK-3, PK-4	PK-3, PK-4, PK-6	PK-4, PK-6
Adjustment component	Slotted head screw								
	Knurled screw			-					
Type of mounting	Screw-in								
Mounting position	Any								
Max. tightening torque [Nm]	1.5	6	11				1.5	6	11

1) - - Note: This product conforms to ISO 1179-1 and ISO 228-1.

## Operating and environmental conditions

Pneumatic connection 2	M5	G1/8	G1/4	G3/8	G1/2	G3/4
Operating pressure [bar]	0.2 ... 10		0.3 ... 10			
Operating medium	Compressed air in accordance with ISO 8573-1:2010 [7:4:4]					
Note on operating/pilot medium	Operation with lubricated medium possible (in which case lubricated operation will always be required)					
Ambient temperature [°C]	-10 ... +60					
Temperature of medium [°C]	-10 ... +60					
Storage temperature [°C]	-10 ... +40					
Certification	GRLA: Germanischer Lloyd					

# One-way flow control valves GRLA/GRLZ, standard

Technical data – Female thread/barbed connector, metal

Standard nominal flow rate  $q_{nN}$  at 6 → 5 bar  
as a function of turns of the adjusting screw  $n$

GRLA/GRLZ-M5

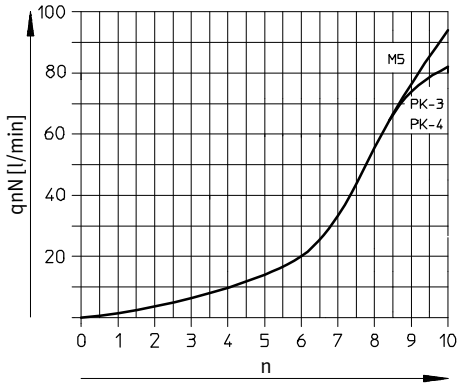

Standard flow rate  $q_n$  at 6 → 0 bar  
as a function of turns of the adjusting screw  $n$

GRLA/GRLZ-M5

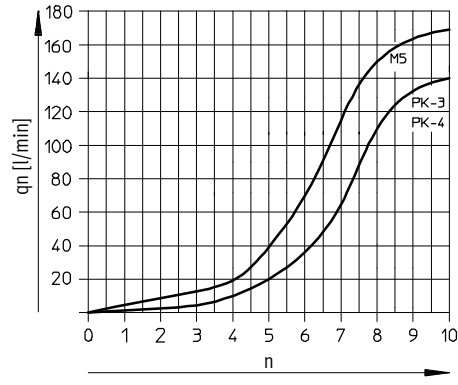

GRLA/GRLZ-1/8

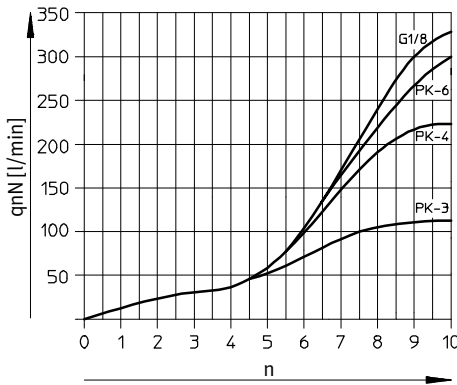

GRLA/GRLZ-1/8

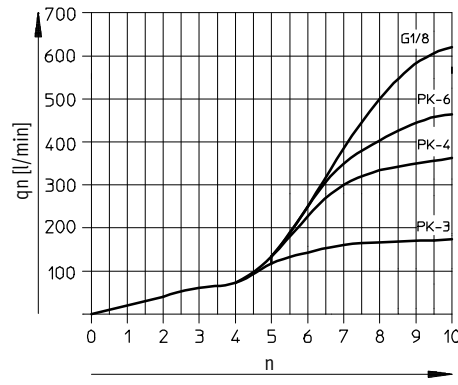

GRLA/GRLZ-1/4

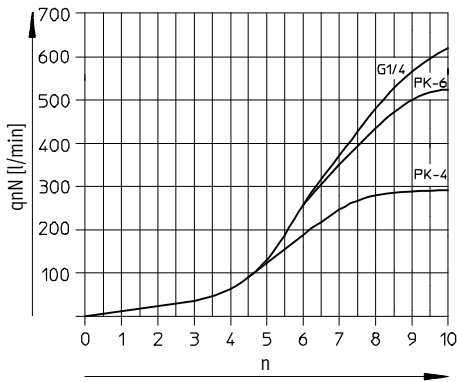

GRLA/GRLZ-1/4

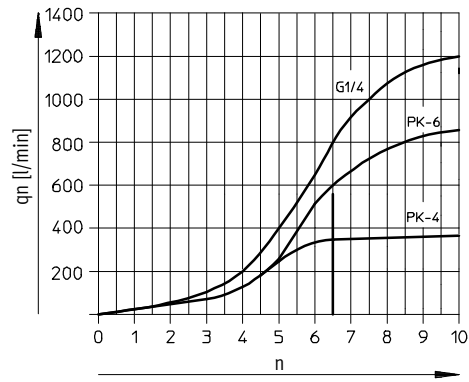

# One-way flow control valves GRLA/GRLZ, standard

Technical data – Female thread/barbed connector, metal

FESTO

Standard nominal flow rate  $q_{nN}$  at 6  $\rightarrow$  5 bar  
as a function of turns of the adjusting screw  $n$

GRLA- $\frac{3}{8}$

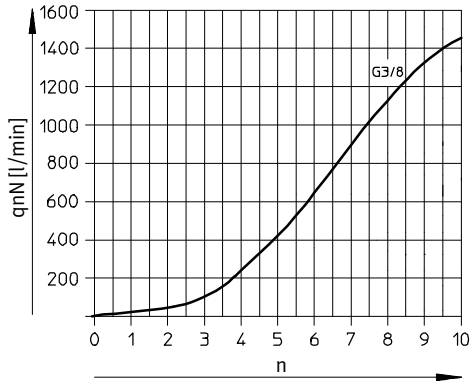

Standard flow rate  $q_n$  at 6  $\rightarrow$  0 bar  
as a function of turns of the adjusting screw  $n$

GRLA- $\frac{3}{8}$

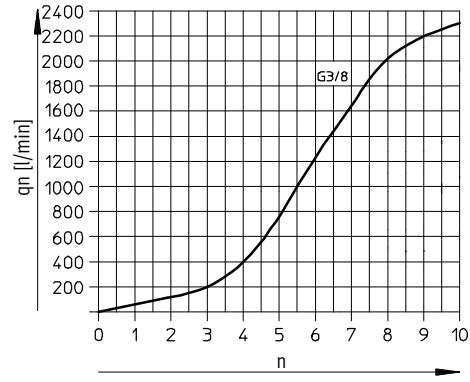

GRLA- $\frac{1}{2}$

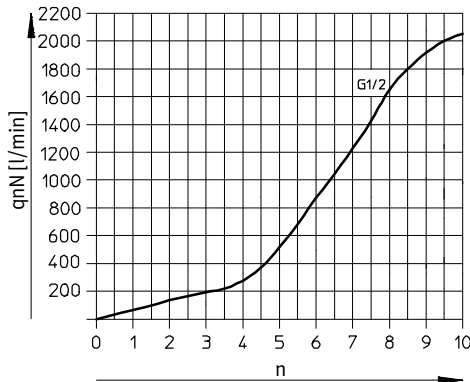

GRLA- $\frac{1}{2}$

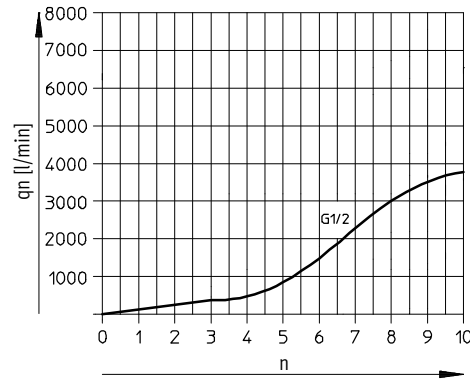

GRLA- $\frac{3}{4}$

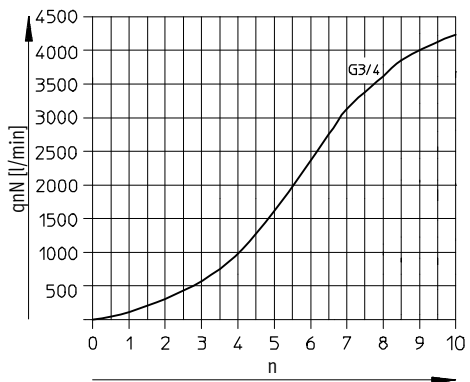

GRLA- $\frac{3}{4}$

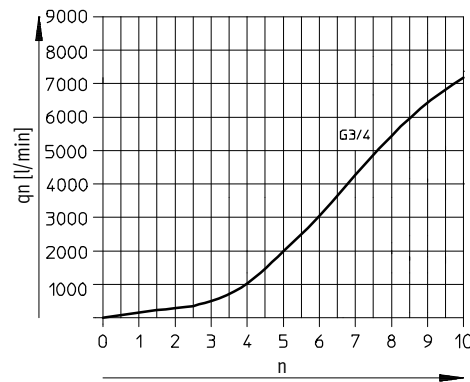

## Materials

Sectional view

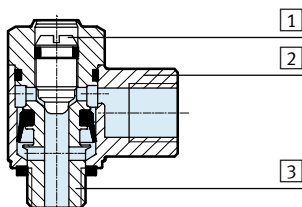

One-way flow control valve

1	Adjusting screw	Brass
2	Swivel connection	Die-cast zinc
3	Threaded plug	Wrought aluminium alloy GRLA/GRLZ-M5: Nickel-plated brass
-	Seals	NBR
Note on materials		RoHS-compliant

# One-way flow control valves GRLA/GRLZ, standard

Technical data – Female thread/barbed connector, metal

## Dimensions – Female thread connection type Download CAD data → [www.festo.com](http://www.festo.com)

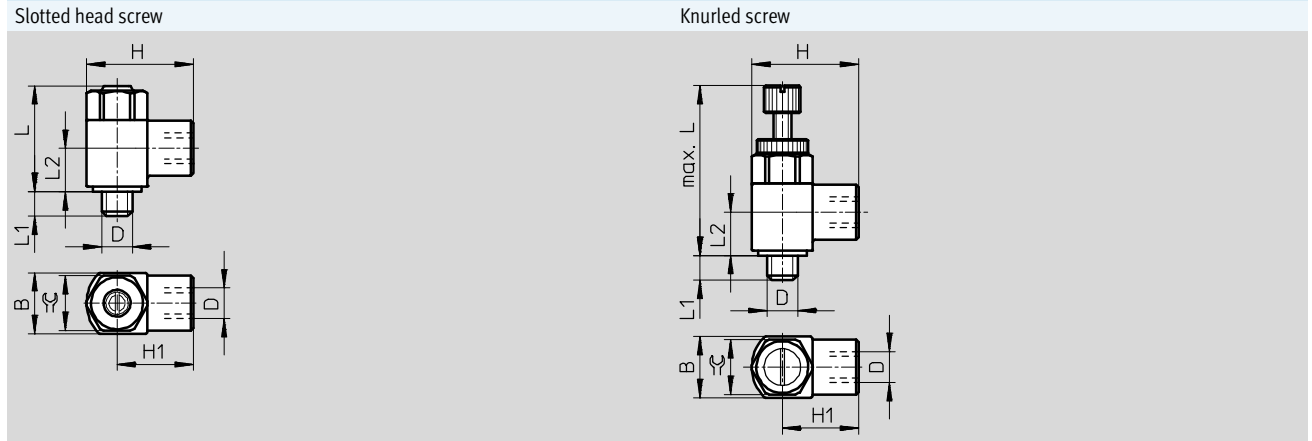

Type	Connection D	Nominal size [mm]	B	H	H1	Lmax.		L1	L2	≙
						Slotted head screw	Knurled screw			
GRL...-M5	M5	2	10 -0.15	17.5	12.5	17.6	27.3	4.0 ±0.3	7.1	9
GRL...-1/8	G1/8	4	16 -0.15	28	20	25.2	38.6	5.3 +0.45/-0.35	10.3	14
GRL...-1/4	G1/4	6	20 -0.2	36	26	30.8	54.8	8.2 +0.45/-0.35	13.2	17
GRLA-3/8	G3/8	8.5	25 -0.2	41	28.5	37.2	-	8.8 +0.45/-0.35	15.5	22
GRLA-1/2	G1/2	10.6	32 -0.2	53	37	48.6	-	12.8 ±0.45	18.9	27
GRLA-3/4	G3/4	14	41 -0.3	64	43.5	60.2	-	13.5 ±0.5	24.5	36

– Note: This product conforms to ISO 1179-1 and to ISO 228-1

## Dimensions – Barbed connector connection type Download CAD data → [www.festo.com](http://www.festo.com)

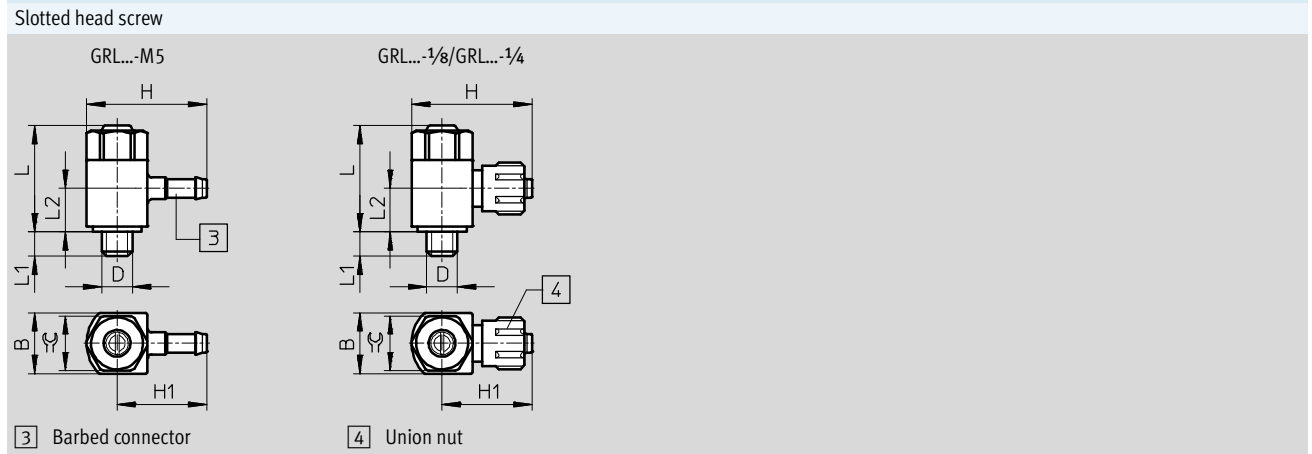



Type	Connection D	Nominal size [mm]	B	H	H1	L max.	L1	L2	≙
GRL...-M5-PK-3	M5	2	10 -0.15	19.7	14.7	17.6	4.0 ±0.3	8.5	9
GRL...-M5-PK-4			10 -0.15	21.7	16.7	17.6	4.0 ±0.3	8.5	9
GRL...-1/8-PK-3	G1/8	4	16 -0.15	27.1	19.1	25.2	5.3 +0.45/-0.35	13.4	14
GRL...-1/8-PK-4			16 -0.15	30.2	22.2	25.2	5.3 +0.45/-0.35	13.4	14
GRL...-1/8-PK-6			16 -0.15	30.3	22.3	25.2	5.3 +0.45/-0.35	12.0	14
GRL...-1/4-PK-4	G1/4	6	20 -0.2	34.2	24.2	30.8	8.2 +0.45/-0.35	16.9	17
GRL...-1/4-PK-6			20 -0.2	34.3	24.3	30.8	8.2 +0.45/-0.35	17.2	17



# One-way flow control valves GRLA/GRLZ, standard

FESTO

Technical data – Female thread/barbed connector, metal

Ordering data – Exhaust air one-way flow control function									
	Pneumatic connection		Standard nominal flow rate qnN at 6 → 5 bar		Standard flow rate qn at 6 → 0 bar		Weight [g]	Part No.	Type
			in direction of flow control	in non-return direction	in direction of flow control	in non-return direction			
	2	1	[l/min]	[l/min]	[l/min]	[l/min]			
Slotted head screw									
	M5	M5	95	76 ... 95	169	135 ... 170	11	151160	GRLA-M5-B
	G1/8	G1/8	340	260 ... 420	615	470 ... 760	28	151165	GRLA-1/8-B
	G1/4	G1/4	610	450 ... 820	1,200	885 ... 1,615	59	151172	GRLA-1/4-B
	G3/8	G3/8	1,450	970 ... 1,600	2,300	1,540 ... 2,540	97	151178	GRLA-3/8-B
	G1/2	G1/2	2,100	1,550 ... 2,200	4,000	2,950 ... 4,190	204	151179	GRLA-1/2-B
	G3/4	G3/4	4,320	3,220 ... 4,720	7,300	5,440 ... 7,300	377	151180	GRLA-3/4-B
	M5	PK-3	83	72 ... 83	140	120 ... 140	10	151161	GRLA-M5-PK-3-B
		PK-4	83	76 ... 88	140	128 ... 148	10	151162	GRLA-M5-PK-4-B
	G1/8	PK-3 <sup>1)</sup>	110	100 ... 110	162	145 ... 165	22	151166	GRLA-1/8-PK-3-B
		PK-4 <sup>1)</sup>	230	190 ... 240	360	295 ... 375	25	151167	GRLA-1/8-PK-4-B
		PK-6 <sup>1)</sup>	300	210 ... 290	455	320 ... 440	26	151168	GRLA-1/8-PK-6-B
	G1/4	PK-4 <sup>1)</sup>	260	220 ... 260	370	315 ... 370	44	151173	GRLA-1/4-PK-4-B
PK-6 <sup>1)</sup>		540	410 ... 585	840	635 ... 910	45	151174	GRLA-1/4-PK-6-B	
Knurled screw									
	M5	M5	95	76 ... 95	169	135 ... 170	12	151163	GRLA-M5-RS-B
	G1/8	G1/8	340	260 ... 420	615	470 ... 760	30	151169	GRLA-1/8-RS-B
	G1/4	G1/4	610	450 ... 820	1,200	885 ... 1,615	59	151175	GRLA-1/4-RS-B

1) Via union nut

Ordering data – Supply air one-way flow control function									
	Pneumatic connection		Standard nominal flow rate qnN at 6 → 5 bar		Standard flow rate qn at 6 → 0 bar		Weight [g]	Part No.	Type
			in direction of flow control	in non-return direction	in direction of flow control	in non-return direction			
	2	1	[l/min]	[l/min]	[l/min]	[l/min]			
Slotted head screw									
	M5	M5	95	76 ... 95	169	135 ... 170	11	151183	GRLZ-M5-B
	G1/8	G1/8	340	260 ... 420	615	470 ... 760	28	151188	GRLZ-1/8-B
	G1/4	G1/4	610	450 ... 820	1,200	885 ... 1,615	59	151195	GRLZ-1/4-B
	M5	PK-3	83	72 ... 83	140	120 ... 140	10	151184	GRLZ-M5-PK-3-B
		PK-4	83	76 ... 88	140	125 ... 150	10	151185	GRLZ-M5-PK-4-B
	G1/8	PK-3 <sup>1)</sup>	110	100 ... 110	162	145 ... 165	22	151189	GRLZ-1/8-PK-3-B
		PK-4 <sup>1)</sup>	230	190 ... 240	360	295 ... 375	25	151190	GRLZ-1/8-PK-4-B
		PK-6 <sup>1)</sup>	300	210 ... 290	455	320 ... 440	26	151191	GRLZ-1/8-PK-6-B
	G1/4	PK-4 <sup>1)</sup>	260	220 ... 260	370	315 ... 370	44	151196	GRLZ-1/4-PK-4-B
PK-6 <sup>1)</sup>		540	410 ... 585	840	635 ... 910	45	151197	GRLZ-1/4-PK-6-B	
Knurled screw									
	M5	M5	95	76 ... 95	169	135 ... 170	12	151186	GRLZ-M5-RS-B
	G1/8	G1/8	340	260 ... 420	615	470 ... 760	30	151192	GRLZ-1/8-RS-B
	G1/4	G1/4	610	450 ... 820	1,200	885 ... 1,615	59	151198	GRLZ-1/4-RS-B

1) Via union nut





# One-way flow control valves GRLSA, standard

Technical data – Push-in connector QS, metal

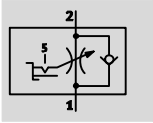
One-way flow control function  
Exhaust air



-  Flow rate  
0 ... 450 l/min
-  Temperature range  
-10 ... +60 °C
-  Operating pressure  
0.2 ... 10 bar



This one-way flow control valve offers the ideal conditions for optimum and easy setting of the flow rate in a unique design.

There are two setting options:

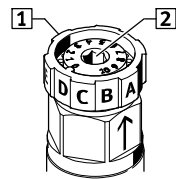

1 Gradual for preselection of the flow range in 5 stages via rotary switch: A, B, C, D, E

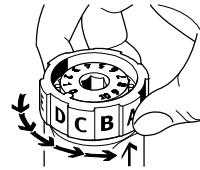

2 Infinitely variable for precision adjustment using internal hex via a scale marked from 0 to 10

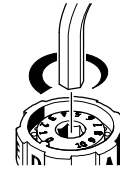

General technical data		
Valve function	Exhaust air one-way flow control function	
Pneumatic connection 2	G1/8	G1/4
Pneumatic connection 1	QS-6	QS-8
Adjustment component	Rotary knob with scale and internal hex	
Actuation type	Manual	
Type of mounting	Screw-in	
Mounting position	Any	
Nominal tightening torque [Nm]	3.5 ±20%	11 ±10%

Operating and environmental conditions		
Operating pressure complete temperature range [bar]	0.2 ... 10	
Operating medium	Compressed air in accordance with ISO 8573-1:2010 [7:4:4]	
Note on operating/pilot medium	Operation with lubricated medium possible (in which case lubricated operation will always be required)	
Ambient temperature [°C]	-10 ... +60	
Temperature of medium [°C]	-10 ... +60	
Storage temperature [°C]	-10 ... +40	

# One-way flow control valves GRLSA, standard

Technical data – Push-in connector QS, metal



Standard nominal flow rate  $q_{nN}$  at 6 → 5 bar  
as a function of the position of the flow control screw (scale)  $n$   
GRLSA-1/8

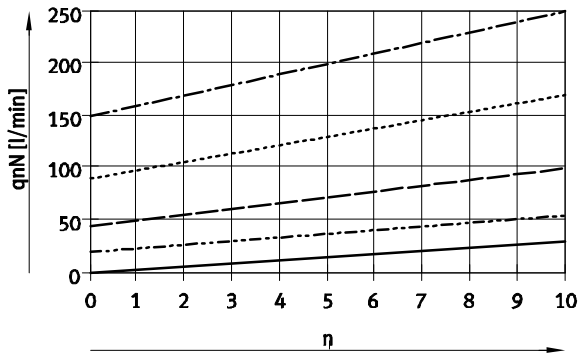

Standard flow rate  $q_n$  at 6 → 0 bar  
as a function of the position of the flow control screw (scale)  $n$   
GRLSA-1/8

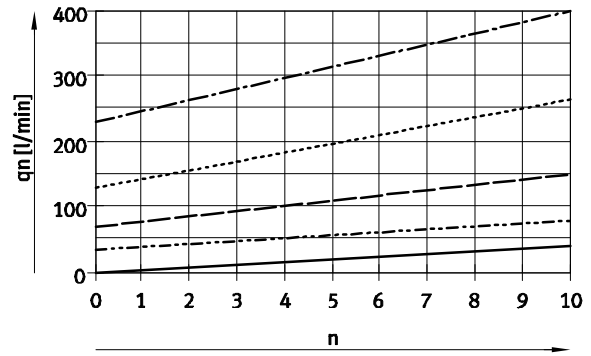

GRLSA-1/4

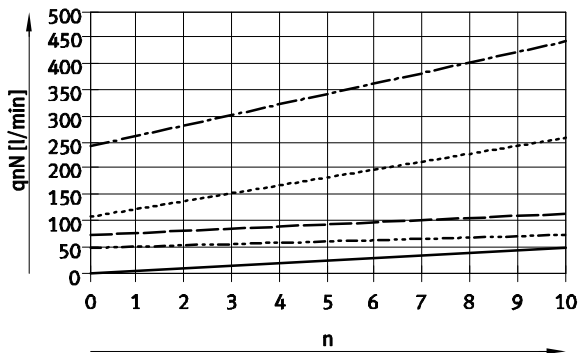

GRLSA-1/4

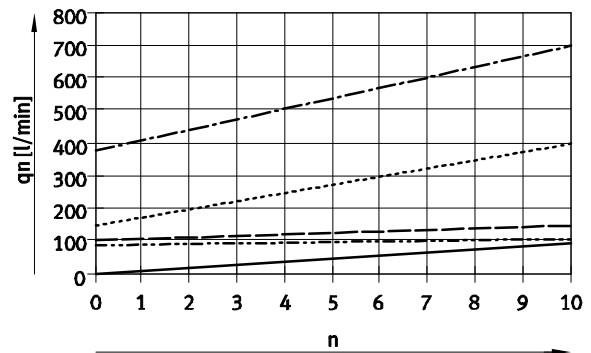

- Stage: A
- - - Stage: B
- Stage: C
- - - Stage: D
- · - Stage: E

Flow rate value tolerance:  $\pm 20\%$

## Materials

Sectional view

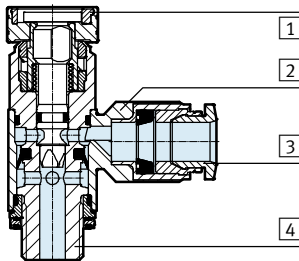

One-way flow control valve

1	Adjusting screw	PA, reinforced
2	Swivel connection	Die-cast zinc
3	Releasing ring	POM
4	Hollow bolt	Anodised wrought aluminium alloy
-	Seals	NBR
Note on materials		RoHS-compliant
		Free of copper and PTFE

# One-way flow control valves GRLSA, standard

Technical data – Push-in connector QS, metal

## Dimensions

Download CAD data → [www.festo.com](http://www.festo.com)

Rotary knob with scale and internal hex

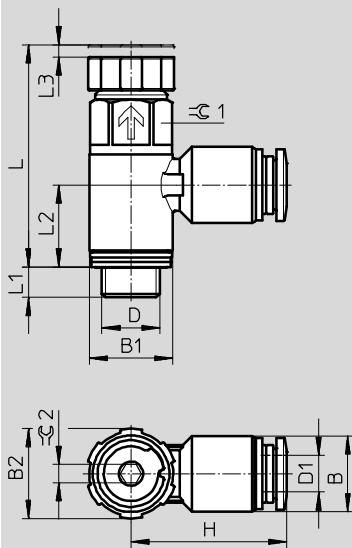

Type	Connection	Tubing O.D.	B	B1	B2	H	L max.	L1	L2	L3	☉1	☉2
	D	D1										
GRLSA-1/8	G1/8	6	12.5	13.8	15	25.7	36.6	5.1	13.5	2	12	3
GRLSA-1/4	G1/4	8	14.5	17.8	18.8	30.75	46.5	7	17.2	3	15	3

## Ordering data – Exhaust air one-way flow control function

	Pneumatic connection		Standard nominal flow rate q <sub>nN</sub> at 6 → 5 bar		Standard flow rate q <sub>n</sub> at 6 → 0 bar		Weight [g]	Part No.	Type
			in direction of flow control	in non-return direction	in direction of flow control	in non-return direction			
			[l/min]	[l/min]	[l/min]	[l/min]			
Rotary knob with scale and internal hex									
	G1/8	QS-6	0 ... 250	180 ... 310	0 ... 410	430 ... 540	19.5	540661	GRLSA-1/8-QS-6
	G1/4	QS-8	0 ... 450	390 ... 570	0 ... 700	820 ... 930	34.8	540662	GRLSA-1/4-QS-8



# One-way flow control valves VFOC, standard

Technical data – Push-in connector QS, metal

FESTO

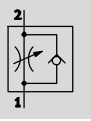
One-way flow control function  
Supply air



-  - Flow rate  
0 ... 270 l/min
-  - Temperature range  
-10 ... +60 °C
-  - Operating pressure  
0.2 ... 10 bar



General technical data		
Valve function	Supply air one-way flow control function	
Pneumatic connection 2	Push-in sleeve QS-4	Push-in sleeve QS-6
Pneumatic connection 1	QS-4	QS-6
Note on the pneumatic connection 2	Only suitable for push-in connector QS from Festo	
Adjustment component	Slotted head screw	
Actuation type	Manual	
Type of mounting	Plug-in, with push-in sleeve	
Mounting position	Any	

Operating and environmental conditions		
Operating pressure [bar]	0.2 ... 10	
Operating medium	Compressed air in accordance with ISO 8573-1:2010 [7:4:4]	
Note on operating/pilot medium	Operation with lubricated medium possible (in which case lubricated operation will always be required)	
Ambient temperature [°C]	-10 ... +60	
Temperature of medium [°C]	-10 ... +60	
Storage temperature [°C]	-10 ... +40	

Standard nominal flow rate  $q_{nN}$  at 6 → 5 bar  
as a function of turns of the adjusting screw  $n$

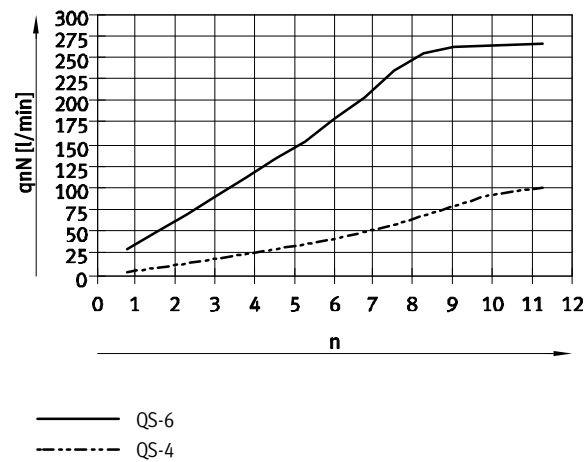

Standard flow rate  $q_n$  at 6 → 0 bar  
as a function of turns of the adjusting screw  $n$

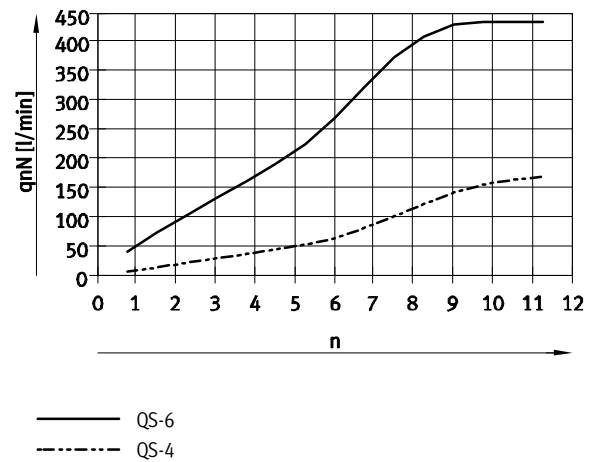

# One-way flow control valves VFOC, standard

Technical data – Push-in connector QS, metal

## Materials

Sectional view

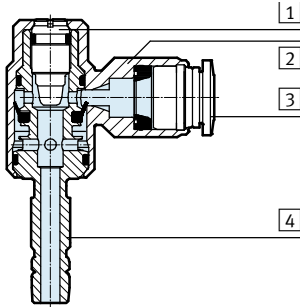

One-way flow control valve

1	Adjusting screw	High-alloy stainless steel
2	Swivel connection	Die-cast zinc
3	Releasing ring	POM
4	Hollow bolt	Black anodised wrought aluminium alloy
-	Seals	NBR
Note on materials		RoHS-compliant

## Dimensions

Download CAD data → [www.festo.com](http://www.festo.com)

Slotted head screw

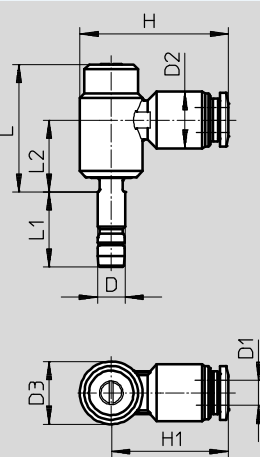

Note

The push-in sleeves of the one-way flow control valves VFOC are exclusively matched to push-in fittings QS from Festo

→ [www.festo.com/catalogue](http://www.festo.com/catalogue)  
This combination alone guarantees a secure grip in the push-in fitting.

Type	Push-in sleeve Ø D	Tubing O.D. D1	D2 Ø	D3 Ø	H	H1	L	L1	L2
VFOC-S-S4-Q4	4	4	10	8.9	24.7	20.3	23.2	14.8	13.2
VFOC-S-S6-Q6	6	6	12.5	13.8	32.6	25.7	28	16.5	15.8

## Ordering data – Supply air one-way flow control function



	Pneumatic connection		Standard nominal flow rate qnN at 6 → 5 bar		Standard flow rate qn at 6 → 0 bar		Weight [g]	Part No.	Type
			in direction of flow control	in non-return direction	in direction of flow control	in non-return direction			
			[l/min]	[l/min]	[l/min]	[l/min]			
	2	1							
	Push-in sleeve QS-4	QS-4	0 ... 100	60 ... 100	0 ... 170	130 ... 160	9.2	559723	VFOC-S-S4-Q4
	Push-in sleeve QS-6	QS-6	0 ... 270	170 ... 260	0 ... 430	330 ... 400	21.6	559724	VFOC-S-S6-Q6

# One-way flow control valves VFOH-LE, standard

Technical data – Push-in connector QS, nickel-plated metal

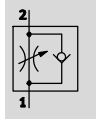
One-way flow control function  
Exhaust air



-  Flow rate  
180 ... 530 l/min
-  Temperature range  
0 ... +150 °C
-  Operating pressure  
0.2 ... 10 bar



- 360° orientable around the screw-in axis after mounting

General technical data		
Valve function	Exhaust air one-way flow control function	
Pneumatic connection 2	G1/8	G1/4
Pneumatic connection 1	QS-4, QS-6, QS-8	QS-8, QS-10
Adjustment element	External hex	
Actuation type	Manual	
Type of mounting	Screw-in	
Mounting position	Any	
Nominal tightening torque [Nm]	3 ±10%	5 ±10%

Operating and environmental conditions	
Operating pressure complete [bar]	0.2 ... 10
temperature range	
Operating medium	Compressed air in accordance with ISO 8573-1:2010 [7:4:4]
Note on operating/pilot medium	Operation with lubricated medium possible (in which case lubricated operation will always be required)
Ambient temperature [°C]	0 ... +150
Temperature of medium [°C]	0 ... +150
Storage temperature [°C]	-10 ... +150
Corrosion resistance class CRC <sup>1)</sup>	3

1) CRC3: Corrosion resistance class to Festo standard 940 070  
Components with heavy corrosion exposure. Externally visible components in direct contact with normal industrial atmosphere or media such as solvents and cleaning agents, where the surface requirement is predominantly functional.

## Standard nominal flow rate qnN at 6 → 5 bar as a function of turns of the adjusting screw n

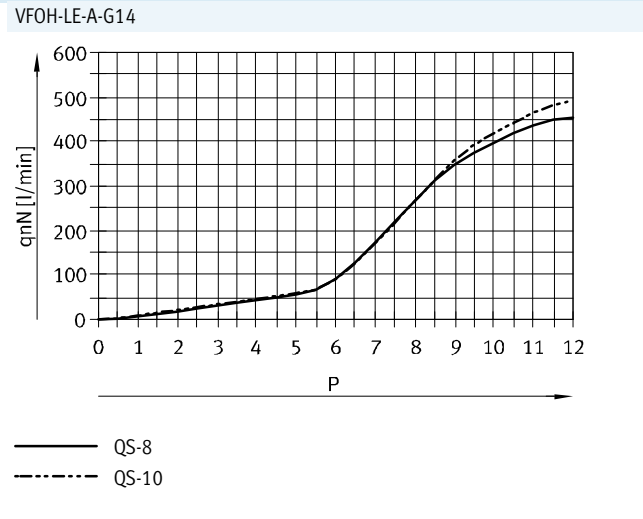
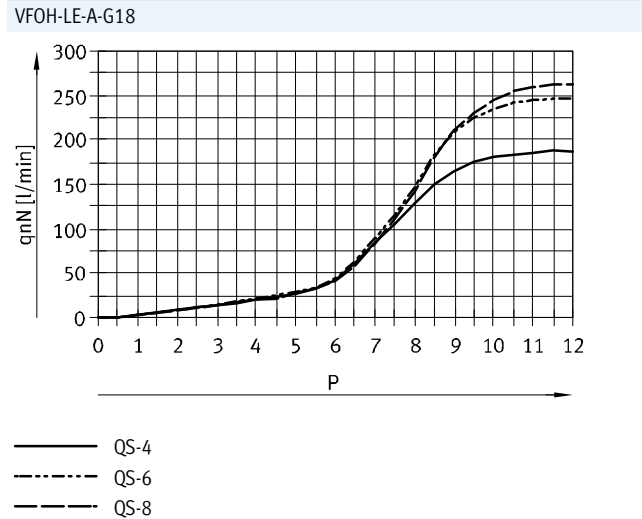

# One-way flow control valves VFOH-LE, standard

Technical data – Push-in connector QS, nickel-plated metal

## Materials

Sectional view

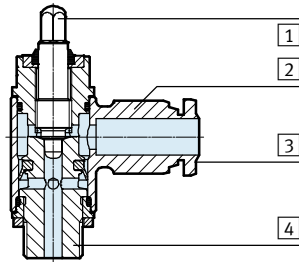

One-way flow control valve

1	Adjusting screw	High-alloy stainless steel
2	Swivel connection	Nickel-plated brass
3	Releasing ring	Nickel-plated brass
4	Hollow bolt	Wrought aluminium alloy
-	Seals	FPM
Note on materials		RoHS-compliant
		Free of copper and PTFE

## Dimensions

Download CAD data → [www.festo.com](http://www.festo.com)

External hex

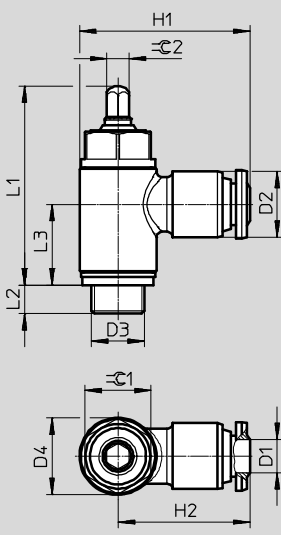

Type	Connection	Tubing O.D.	D2	D4	H1	H2	L1	L2	L3	⌀1	⌀2
	D3	D1	∅	∅							
VFOH-LE-A-G18	G1/8	4	10.5	14	28	21	36.3	5.2	14.8	12	4
		6	12		31	24					
		8	14		32	25					
VFOH-LE-A-G14	G1/4	8	14	18	36	27	39.9	6.1	17.5	15	5
		10	17.7		41	32					

## Ordering data – Exhaust air one-way flow control function

Pneumatic connection	Standard nominal flow rate q <sub>N</sub>		Standard flow rate q <sub>n</sub>		Weight	Part No.	Type		
	at 6 → 5 bar		at 6 → 0 bar						
	in direction of flow control	in non-return direction	in direction of flow control	in non-return direction					
2	1	[l/min]	[l/min]	[l/min]	[l/min]	[g]			
	G1/8	QS-4	180	103 ... 188	250	270 ... 300	25	<b>578797</b>	<b>VFOH-LE-A-G18-Q4</b>
		QS-6	255	111 ... 280	370	330 ... 390		<b>578798</b>	<b>VFOH-LE-A-G18-Q6</b>
		QS-8	275	132 ... 307	400	330 ... 410		<b>578799</b>	<b>VFOH-LE-A-G18-Q8</b>
	G1/4	QS-8	530	402 ... 578	720	610 ... 760	37	<b>578800</b>	<b>VFOH-LE-A-G14-Q8</b>
		QS-10	520	345 ... 535	840	635 ... 790	48	<b>578801</b>	<b>VFOH-LE-A-G14-Q10</b>



# One-way flow control valves GRLA, standard

Technical data – Push-in connector QS, polymer

FESTO

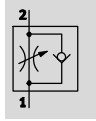
One-way flow control function  
Exhaust air



-  - Flow rate  
520 ... 650 l/min
-  - Temperature range  
-10 ... +60 °C
-  - Operating pressure  
0.2 ... 10 bar

- Can be swivelled 360° around the screw-in axis after mounting



General technical data			
Valve function	Exhaust air one-way flow control function		
Pneumatic connection 2	G1/8	G1/4	G3/8
Pneumatic connection 1	QS-6, QS-8	QS-6, QS-8	QS-6, QS-8
Adjustment component	Knurled screw		
Actuation type	Manual		
Type of mounting	Screw-in		
Mounting position	Any		
Nominal tightening torque [Nm]	3.5 ±20%	11 ±10%	12.5 ±20%
Perm. actuation torque for regulating screw [Nm]	0.4		

Operating and environmental conditions	
Operating pressure complete temperature range [bar]	0.2 ... 10
Operating medium	Compressed air in accordance with ISO 8573-1:2010 [7:4:4]
Note on operating/pilot medium	Operation with lubricated medium possible (in which case lubricated operation will always be required)
Ambient temperature [°C]	-10 ... +60
Temperature of medium [°C]	-10 ... +60
Storage temperature [°C]	-10 ... +40
Corrosion resistance class CRC <sup>1)</sup>	2

1) Corrosion resistance class CRC 2 to Festo standard FN 940070

Moderate corrosion stress. Indoor applications in which condensation may occur. External visible parts with primarily decorative requirements for the surface and which are in direct contact with the ambient atmosphere typical for industrial applications.

Standard nominal flow rate  $q_{nN}$  at 6 → 5 bar as a function of turns of the adjusting screw  $n$

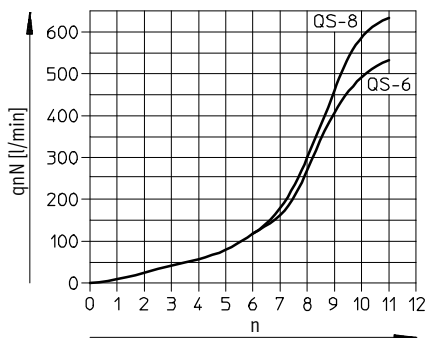

Standard flow rate  $q_n$  at 6 → 0 bar as a function of turns of the adjusting screw  $n$

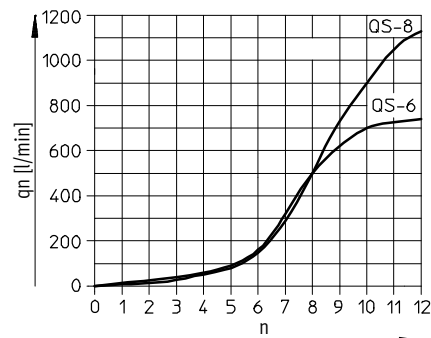



# One-way flow control valves GRLA, standard

Technical data – Push-in connector QS, polymer

## Materials

Sectional view

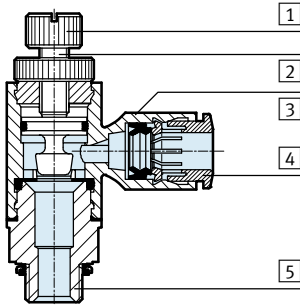

One-way flow control valve

1	Knurled head	Wrought aluminium alloy
2	Regulating screw	Brass
3	Swivel connection	PBT, reinforced
4	Releasing ring	POM
5	Threaded plug	Wrought aluminium alloy
-	Seals	TPE-U(PU) NBR
Note on materials		RoHS-compliant

## Dimensions

Download CAD data → [www.festo.com](http://www.festo.com)

Knurled screw

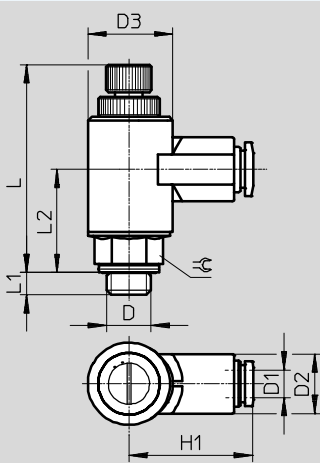

Type	Connection D	Tubing O.D. D1	D2 ∅	D3	H1	L max.	L1	L2	⊕
GRLA-1/8	G1/8	6	13.0 ±0.25	17.9 -0.1	27.2	48	4.9	22.6	13
		8	16.8 ±0.4		35.4				
GRLA-1/4	G1/4	6	13.0 ±0.25	17.9 -0.1	27.2	48	5.8	22.3	17
		8	16.8 ±0.4		35.4				
GRLA-3/8	G3/8	6	13.0 ±0.25	17.9 -0.1	27.2	48	6.8	22.3	19
		8	16.8 ±0.4		35.4				

## Ordering data – Exhaust air one-way flow control function

	Pneumatic connection		Standard nominal flow rate q <sub>nN</sub> at 6 → 5 bar		Standard flow rate q <sub>n</sub> at 6 → 0 bar		Weight [g]	Part No.	Type
			in direction of flow control	in non-return direction	in direction of flow control	in non-return direction			
			[l/min]	[l/min]	[l/min]	[l/min]			
<b>Knurled screw</b>									
	G1/8	QS-6	520	400 ... 550	720	600 ... 750	25	162965	GRLA-1/8-QS-6-RS-B
		QS-8	650	600 ... 750	1,080	800 ... 1,250		162966	GRLA-1/8-QS-8-RS-B
	G1/4	QS-6	520	400 ... 550	720	600 ... 750	30	162967	GRLA-1/4-QS-6-RS-B
		QS-8	650	600 ... 750	1,130	800 ... 1,250		162968	GRLA-1/4-QS-8-RS-B
	G3/8	QS-6	530	400 ... 550	720	600 ... 750	40	162969	GRLA-3/8-QS-6-RS-B
		QS-8	650	600 ... 750	1,130	800 ... 1,250		162970	GRLA-3/8-QS-8-RS-B

# One-way flow control valves GRLA/GRLZ/GRGA/GRGZ, mini

FESTO



Technical data – Push-in connector QS, metal

One-way flow control function

Exhaust air

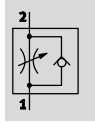
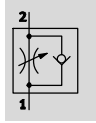
Supply air



-  Flow rate  
40 ... 48 l/min
-  Temperature range  
-10 ... +60 °C
-  Operating pressure  
0.2 ... 10 bar

- Low flow: precision adjustment for low speed



## General technical data – GRLA/GRGA

Valve function	Exhaust air one-way flow control function	
Pneumatic connection 2	M3	M5
Pneumatic connection 1	QS-3	QS-3, QS-4
Adjustment component	Slotted head screw	
Type of mounting	Screw-in	
Mounting position	Any	
Max. tightening torque [Nm]	0.3	1.5

## General technical data – GRLZ/GRGZ

Valve function	Supply air one-way flow control function	
Pneumatic connection 2	M3	M5
Pneumatic connection 1	QS-3	QS-3, QS-4
Adjustment component	Slotted head screw	
Type of mounting	Screw-in	
Mounting position	Any	
Max. tightening torque [Nm]	0.3	1.5

## Operating and environmental conditions

Operating pressure [bar]	0.2 ... 10
Operating medium	Compressed air in accordance with ISO 8573-1:2010 [7:4:4]
Note on operating/pilot medium	Operation with lubricated medium possible (in which case lubricated operation will always be required)
Ambient temperature [°C]	-10 ... +60
Temperature of medium [°C]	-10 ... +60
Storage temperature [°C]	-10 ... +40
Certification	GRLA: Germanischer Lloyd

# One-way flow control valves GRLA/GRLZ/GRGA/GRGZ, mini

Technical data – Push-in connector QS, metal

**Standard nominal flow rate  $q_{nN}$  at 6 → 5 bar as a function of turns of the adjusting screw n**  
GRLA/GRLZ/GRGA/GRGZ-M3

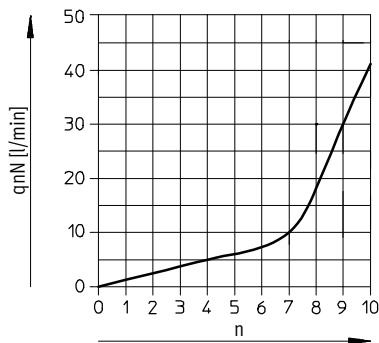

**Standard flow rate  $q_n$  at 6 → 0 bar as a function of turns of the adjusting screw n**  
GRLA/GRLZ/GRGA/GRGZ-M3

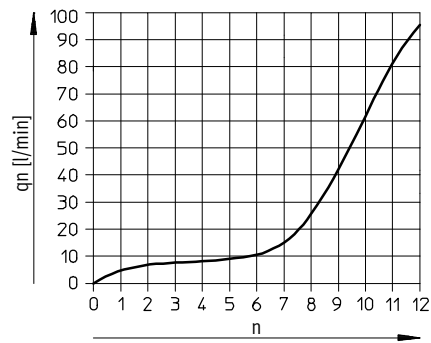

GRLA/GRLZ-M5

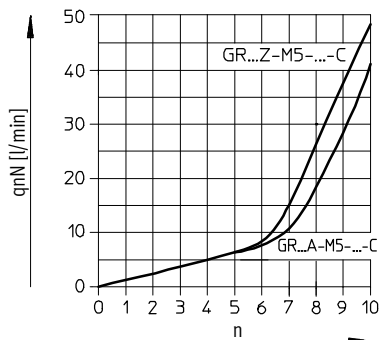

GRLA/GRLZ-M5

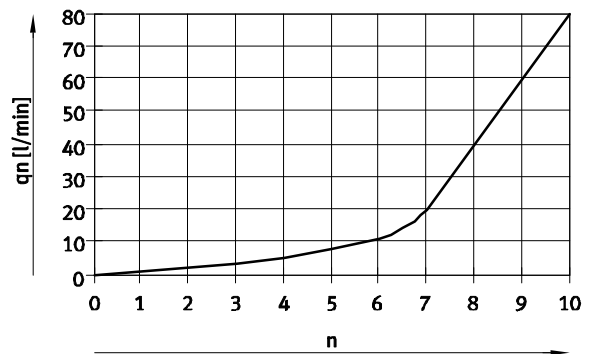

## Materials

Sectional view

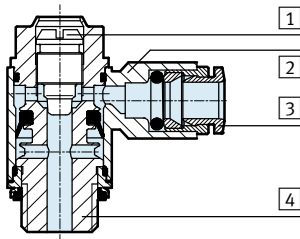

One-way flow control valve

1	Adjusting screw	Brass
2	Swivel connection	Die-cast zinc
3	Releasing ring	POM
4	Threaded plug	Nickel-plated brass
-	Seals	NBR
Note on materials		RoHS-compliant

# One-way flow control valves GRLA/GRLZ/GRGA/GRGZ, mini

FESTO

Technical data – Push-in connector QS, metal

Dimensions Download CAD data → [www.festo.com](http://www.festo.com)

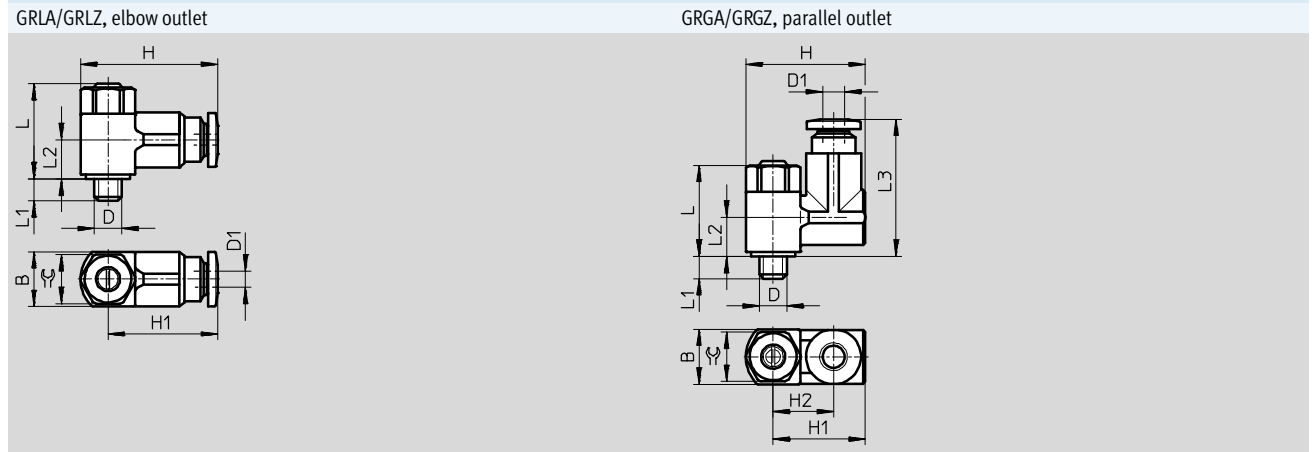

Type	Connection	Nominal size	Tubing O.D.	B	H	H1	H2	L max.	L1	L2	L3	⌀
	D	[mm]	D1									
GRLA/GRLZ	M3	1.4	3	8 <sup>-0.15</sup>	20	15.8	-	16.6	2.3 <sup>+0.15/-0.3</sup>	7	-	7
	M5	1.4	3	9.8 <sup>-0.15</sup>	22.4	18.4		17.7	3.1 <sup>+0.15/-0.35</sup>	7.3		
		1.4	4	9.8 <sup>-0.15</sup>	22.2	18.2		17.7	3.1 <sup>+0.15/-0.35</sup>	7.3		
GRGA/GRGZ	M3	1.4	3	8 <sup>-0.15</sup>	18	14	9.25	16.6	2.3 <sup>+0.15/-0.3</sup>	7.5	22	7

Ordering data – Exhaust air one-way flow control function										
	Pneumatic connection		Standard nominal flow rate qnN at 6 → 5 bar		Standard flow rate qn at 6 → 0 bar		Weight [g]	Part No.	Type	
			in direction of flow control	in non-return direction	in direction of flow control	in non-return direction				
	2	1	[l/min]	[l/min]	[l/min]	[l/min]				
Slotted head screw										
	M3	QS-3	41	27 ... 50	95	75 ... 110	7	175041	GRLA-M3-QS-3	
	M5	QS-3	40	46 ... 70	80	90 ... 140	9	175053	GRLA-M5-QS-3-LF-C	
		QS-4	40	50 ... 75	80	100 ... 150	9	175056	GRLA-M5-QS-4-LF-C	
	M3	QS-3	41	27 ... 50	95	75 ... 110	14	175044	GRGA-M3-QS-3	

Ordering data – Supply air one-way flow control function										
	Pneumatic connection		Standard nominal flow rate qnN at 6 → 5 bar		Standard flow rate qn at 6 → 0 bar		Weight [g]	Part No.	Type	
			in direction of flow control	in non-return direction	in direction of flow control	in non-return direction				
	2	1	[l/min]	[l/min]	[l/min]	[l/min]				
Slotted head screw										
	M3	QS-3	41	27 ... 44	95	75 ... 100	7	175043	GRLZ-M3-QS-3	
	M5	QS-3	48	36 ... 52	80	60 ... 90	9	175055	GRLZ-M5-QS-3-LF-C	
		QS-4	48	40 ... 65	80	65 ... 110	9	175058	GRLZ-M5-QS-4-LF-C	
	M3	QS-3	41	27 ... 44	95	75 ... 100	14	175046	GRGZ-M3-QS-3	

# One-way flow control valves GRLA/GRLZ, mini



Technical data – Female thread, metal

One-way flow control function

Exhaust air

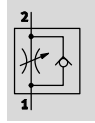
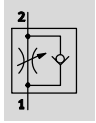
Supply air



-  - Flow rate  
0 ... 18 l/min
-  - Temperature range  
-10 ... +60 °C
-  - Operating pressure  
0.2 ... 10 bar



General technical data – GRLA	
Valve function	Exhaust air one-way flow control function
Pneumatic connection 2	M3
Pneumatic connection 1	M3
Adjustment component	Slotted head screw
Type of mounting	Screw-in
Mounting position	Any
Max. tightening torque [Nm]	0.3

General technical data – GRLZ	
Valve function	Supply air one-way flow control function
Pneumatic connection 2	M3
Pneumatic connection 1	M3
Adjustment component	Slotted head screw
Type of mounting	Screw-in
Mounting position	Any
Max. tightening torque [Nm]	0.3

Operating and environmental conditions	
Operating pressure [bar]	0.2 ... 10
Operating medium	Compressed air in accordance with ISO 8573-1:2010 [7:4:4]
Note on operating/pilot medium	Operation with lubricated medium possible (in which case lubricated operation will always be required)
Ambient temperature [°C]	-10 ... +60
Temperature of medium [°C]	-10 ... +60
Storage temperature [°C]	-10 ... +40
Certification	GRLA: Germanischer Lloyd

Standard nominal flow rate  $q_{nN}$  at 6 → 5 bar as a function of turns of the adjusting screw n

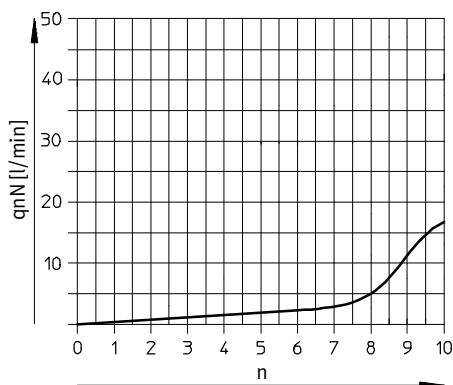

Standard flow rate  $q_n$  at 6 → 0 bar as a function of turns of the adjusting screw n

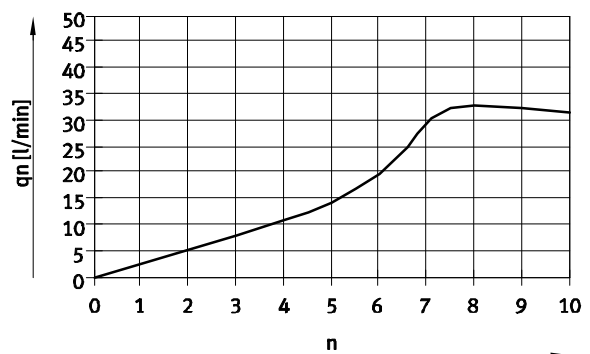

# One-way flow control valves GRLA/GRLZ, mini

Technical data – Female thread, metal



## Materials

Sectional view

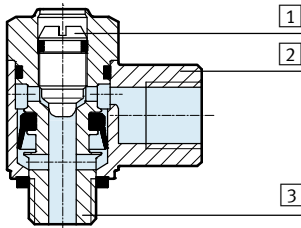

### One-way flow control valve

1	Adjusting screw	Brass
2	Swivel connection	Die-cast zinc
3	Threaded plug	Nickel-plated brass
-	Seals	NBR
Note on materials		RoHS-compliant

## Dimensions

Download CAD data → [www.festo.com](http://www.festo.com)

Slotted head screw

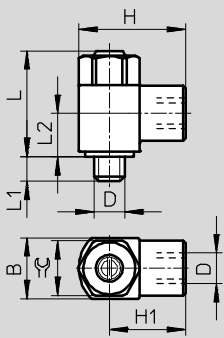

Type	Connection	Nominal size	B	H	H1	L max.	L1	L2	☞
GRLA/GRLZ	M3	0.8 [mm]	5 <sup>-0.1</sup>	9	6.5	13.3	2.5 <sup>+0.15/-0.3</sup>	6.4	4.5

## Ordering data – Exhaust air one-way flow control function

Pneumatic connection	Standard nominal flow rate q <sub>nN</sub> at 6 → 5 bar		Standard flow rate q <sub>n</sub> at 6 → 0 bar		Weight [g]	Part No.	Type
	in direction of flow control	in non-return direction	in direction of flow control	in non-return direction			
2	1	[l/min]	[l/min]	[l/min]	[l/min]		

Slotted head screw

	M3	M3	18	18 ... 20	33	33 ... 37	2	<b>175038</b>	<b>GRLA-M3</b>
--	----	----	----	-----------	----	-----------	---	---------------	----------------

## Ordering data – Supply air one-way flow control function

Pneumatic connection	Standard nominal flow rate q <sub>nN</sub> at 6 → 5 bar		Standard flow rate q <sub>n</sub> at 6 → 0 bar		Weight [g]	Part No.	Type
	in direction of flow control	in non-return direction	in direction of flow control	in non-return direction			
2	1	[l/min]	[l/min]	[l/min]	[l/min]		

Slotted head screw

	M3	M3	18	18 ... 20	33	33 ... 37	2	<b>175040</b>	<b>GRLZ-M3</b>
--	----	----	----	-----------	----	-----------	---	---------------	----------------

# One-way flow control valves CRGRLA, corrosion-resistant

FESTO

Technical data – Female thread, stainless steel

One-way flow control function  
Exhaust air

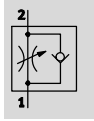

- - Flow rate  
95 ... 2,100 l/min
- - Temperature range  
-20 ... +80 °C
- - Operating pressure  
0.2 ... 10 bar



General technical data						
Valve function		Exhaust air one-way flow control function				
Pneumatic connection 2		M5	G1/8	G1/4	G3/8	G1/2
Pneumatic connection 1		M5	G1/8	G1/4	G3/8	G1/2
Adjustment component		Slotted head screw				
Type of mounting		Screw-in				
Mounting position		Any				
Max. tightening torque	[Nm]	1.5	6	11	20	40
Perm. actuation torque for regulating screw	[Nm]	0.2	0.5	1.5	2	3

-||- Note: This product conforms to ISO 1179-1 and to ISO 228-1

Operating and environmental conditions						
Pneumatic connection 2		M5	G1/8	G1/4	G3/8	G1/2
Operating pressure	[bar]	0.2 ... 10		0.3 ... 10		
Operating medium		Compressed air in accordance with ISO 8573-1:2010 [7:4:4]				
Note on operating/pilot medium		Operation with lubricated medium possible (in which case lubricated operation will always be required)				
Ambient temperature	[°C]	-20 ... +80				
Temperature of medium	[°C]	-10 ... +60				
Storage temperature	[°C]	-10 ... +40				
Corrosion resistance class CRC <sup>1)</sup>		3				
Food-safe <sup>2)</sup>		See supplementary material information				
Approval <sup>2)</sup>		Germanischer Lloyd				

- 1) Corrosion resistance class CRC 3 to Festo standard FN 940070  
High corrosion stress. Outdoor exposure under moderate corrosive conditions. External visible parts with primarily functional requirements for the surface and which are in direct contact with a normal industrial environment.
- 2) Additional information [www.festo.com/sp](http://www.festo.com/sp) → Certificates.

## Standard nominal flow rate $q_{nN}$ at 6 → 5 bar as a function of turns of the adjusting screw n

CRGRLA-M5, CRGRLA-1/8

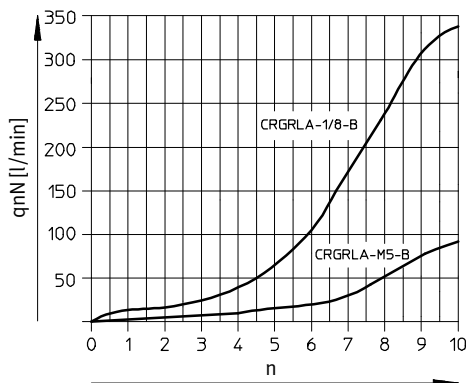

## Standard flow rate $q_n$ at 6 → 0 bar as a function of turns of the adjusting screw n

CRGRLA-M5, CRGRLA-1/8

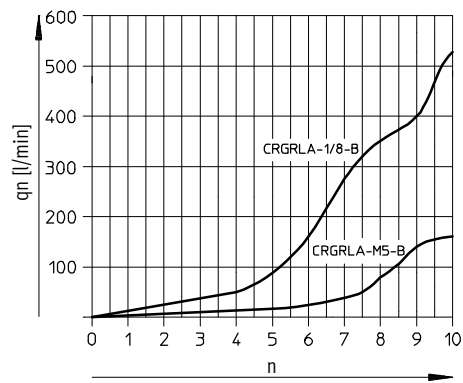

# One-way flow control valves CRGRLA, corrosion-resistant

Technical data – Female thread, stainless steel

FESTO

## Standard nominal flow rate $q_{nN}$ at 6 $\rightarrow$ 5 bar as a function of turns of the adjusting screw $n$

CRGRLA-1/4, CRGRLA-3/8, CRGRLA-1/2

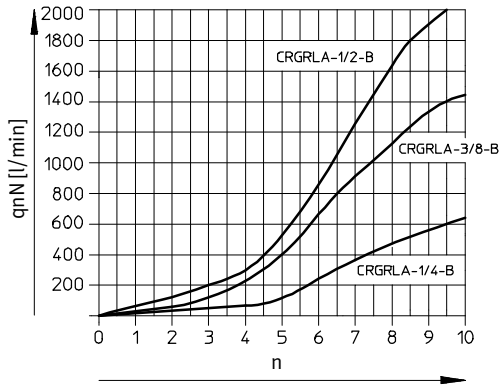

## Standard flow rate $q_n$ at 6 $\rightarrow$ 0 bar as a function of turns of the adjusting screw $n$

CRGRLA-1/4, CRGRLA-3/8, CRGRLA-1/2

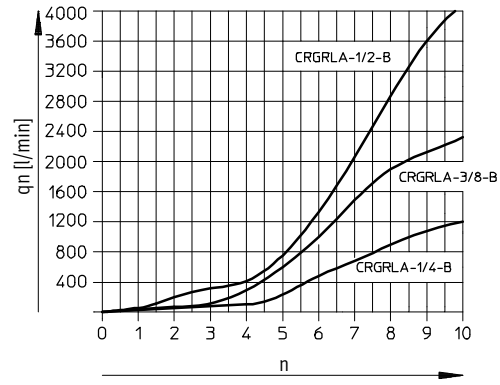

## Materials

Sectional view

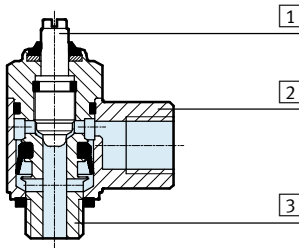

### One-way flow control valve

1	Regulating screw	High-alloy stainless steel
2	Swivel connection	High-alloy stainless steel
3	Hollow bolt	High-alloy steel
-	Seals	FPM, PVC
Note on materials		RoHS-compliant

## Dimensions

Download CAD data [→ www.festo.com](http://www.festo.com)

CRGRLA-M5

CRGRLA-1/8, CRGRLA-1/4, CRGRLA-3/8, CRGRLA-1/2

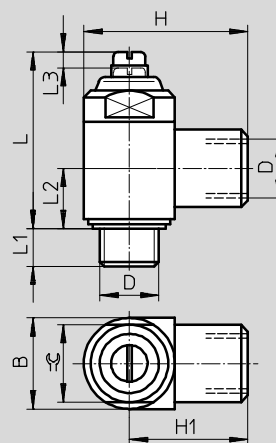
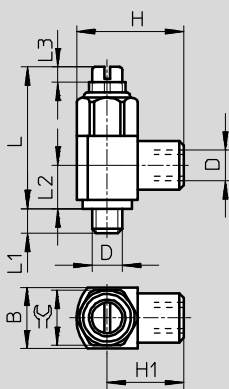

Type	Connection D	Nominal size [mm]	B	H	H1	L	L1	L2	L3	⌀
CRGRLA-M5	M5	2	10 -0.25	17.5 ±0.3	12.5	23.2	4	7.1	2.5	9
CRGRLA-1/8	G1/8	4	16 -0.4	28 +0.4/-0.3	20	33.7	5.5	10.3	3.5	14
CRGRLA-1/4	G1/4	6	20 -0.3	36 +0.4/-0.2	26	38.8	6.5	13.2	3.5	17
CRGRLA-3/8	G3/8	8.5	25 -0.3	41 +0.4/-0.2	28.5	48.5	7.5	15.4	5	22
CRGRLA-1/2	G1/2	10.6	32 -0.4	53 ±0.5	37	62.2	9	18.9	7.5	27

Note: This product conforms to ISO 1179-1 and to ISO 228-1



# One-way flow control valves CRGRLA, corrosion-resistant

Technical data – Female thread, stainless steel

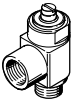
Ordering data – Exhaust air one-way flow control function									
Pneumatic connection		Standard nominal flow rate q <sub>nN</sub> at 6 $\rightarrow$ 5 bar		Standard flow rate q <sub>n</sub> at 6 $\rightarrow$ 0 bar		Weight [g]	Part No.	Type	
		in direction of flow control	in non-return direction	in direction of flow control	in non-return direction				
2	1	[l/min]	[l/min]	[l/min]	[l/min]				
Slotted head screw									
	M5	M5	95	77 ... 95	165	140 ... 150	10.2	<b>161403</b>	<b>CRGRLA-M5-B</b>
	G1/8	G1/8	340	260 ... 420	580	530 ... 590	37.8	<b>161404</b>	<b>CRGRLA-1/8-B</b>
	G1/4	G1/4	610	450 ... 820	1,265	1,030 ... 1,345	71.6	<b>161405</b>	<b>CRGRLA-1/4-B</b>
	G3/8	G3/8	1,450	970 ... 1,600	2,515	2,095 ... 2,665	126.9	<b>161406</b>	<b>CRGRLA-3/8-B</b>
	G1/2	G1/2	2,100	1,550 ... 2,200	4,265	3,550 ... 4,325	262.3	<b>161407</b>	<b>CRGRLA-1/2-B</b>



# One-way flow control valves GRXA, function combination

Technical data – Push-in connector QS, metal

FESTO

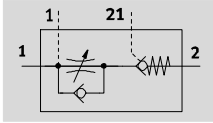
One-way flow control function  
Exhaust air



-  - Flow rate  
130 ... 280 l/min
-  - Temperature range  
-10 ... +60 °C
-  - Operating pressure  
0.5 ... 10 bar



Function example:

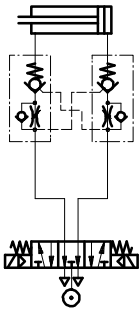

The function combination consists of a one-way flow control valve and a piloted non-return valve. Exhaust air flow control is active as long as a pilot signal from pneumatic connection 21 is applied. If no pilot signal is applied, the valve shuts off the exhaust air. The compressed air flows unthrottled through the non-return valve in the supply air direction.

- Stop function and speed setting in one housing
- Swivel pilot connection 21 perpendicular to screw-in direction
- Additional pilot connection 1 for crossover interconnection, e.g. for stop function with pressure failure  
→ Function example

General technical data			
Valve function		Exhaust air one-way flow control function	
Pneumatic connection 2		G $\frac{1}{8}$	G $\frac{1}{4}$
Pneumatic connection 1		QS-4, QS-6	QS-6, QS-8
Pneumatic connection 21/additional pilot connection 1		QS-4	QS-4
Adjustment component		Slotted head screw	
Actuation type		Pneumatic	
Type of mounting		Screw-in, via male thread	
Mounting position		Any	
Switching time	Off	[ms]	44
	On	[ms]	6
Nominal tightening torque		[Nm]	3.5 ±10%
			11 ±10%

Operating and environmental conditions		
Operating pressure complete	[bar]	0.5 ... 10
temperature range		
Pilot pressure p21	[bar]	2 ... 10
Operating/pilot medium		Compressed air in accordance with ISO 8573-1:2010 [7:4:4]
Note on operating/pilot medium		Operation with lubricated medium possible (in which case lubricated operation will always be required)
Ambient temperature	[°C]	-10 ... +60
Temperature of medium	[°C]	-10 ... +60
Storage temperature	[°C]	-10 ... +40

-  - Note

Additional measures are required for use in safety-related applications; in Europe, for example, the standards listed under the EC Machinery Directive must be observed.

Without additional measures in accordance with statutory minimum requirements, the product is not suitable for use in safety-related sections of control systems.

# One-way flow control valves GRXA, function combination

Technical data – Push-in connector QS, metal

Standard nominal flow rate  $q_{nN}$  at 6 → 5 bar as a function of turns of the adjusting screw n

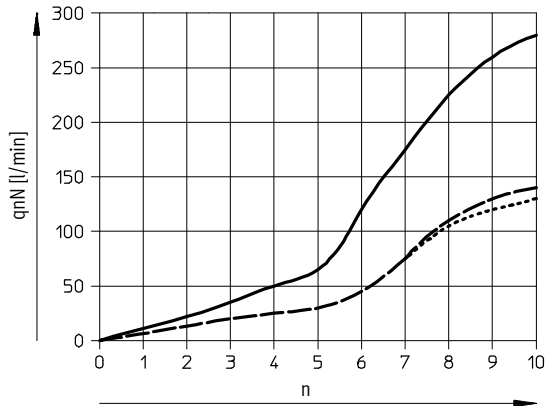

- GRXA-HG-1/4-QS-8,  
GRXA-HG-1/4-QS-6
- - - GRXA-HG-1/8-QS-6
- ..... GRXA-HG-1/8-QS-4

Standard flow rate  $q_n$  at 6 → 0 bar as a function of turns of the adjusting screw n

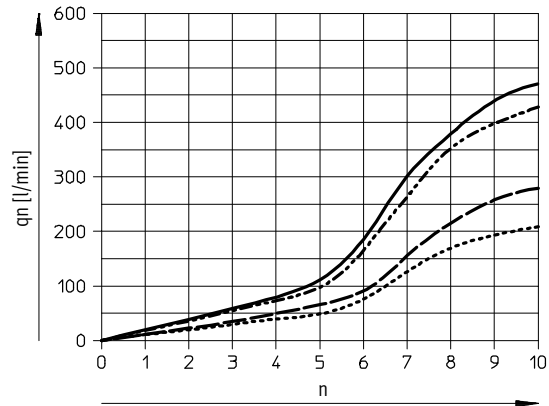

- GRXA-HG-1/4-QS-8
- - - GRXA-HG-1/4-QS-6
- · - GRXA-HG-1/8-QS-6
- ..... GRXA-HG-1/8-QS-4

Minimum pilot pressure  $p_{21}$  as a function of operating pressure  $p_1$

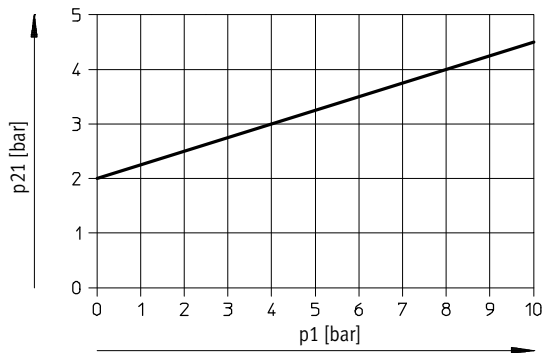

## Materials

Sectional view

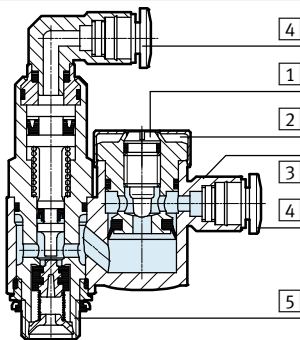

One-way flow control valve		
1	Adjusting screw	Brass
2	Cap	Anodised wrought aluminium alloy
3	Swivel connection	POM
4	Releasing ring	POM
5	Hollow bolt	Anodised wrought aluminium alloy
-	Seals	NBR
Note on materials		RoHS-compliant

# One-way flow control valves GRXA, function combination

Technical data – Push-in connector QS, metal



## Dimensions

Download CAD data → [www.festo.com](http://www.festo.com)

Slotted head screw

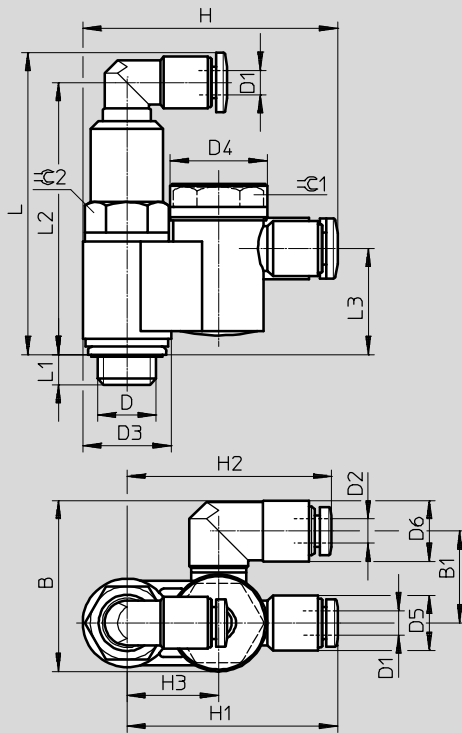

Type	Connection D	Tubing O.D.		B	B1	D3 ∅	D4 ∅	D5 ∅	D6 ∅	H	H1	H2	H3	L	L1	L2	L3	≈C 1	≈C 2
		D1	D2																
GRXA-HG-1/8	G1/8	4	4	28	15	14.5	15.9	9	10	41.8	34.5	33.5	15	49.5	4.9	44.6	17.4	13	12
		4	6	31.5	17.3				12.5	41.8		34.5							
GRXA-HG-1/4	G1/4	4	6	36.1	19.5	19	20.6	9	12.5	52.2	42.7	40.5	21	56.3	5.6	51.4	21.1	17	16
		4	8	40.3	21.5				17	58.2		48.7							

## Ordering data – Exhaust air one-way flow control function

	Pneumatic connection		Standard nominal flow rate q <sub>N</sub> at 6 → 5 bar		Standard flow rate q <sub>n</sub> at 6 → 0 bar		Weight [g]	Part No.	Type
			in direction of flow control	in non-return direction	in direction of flow control	in non-return direction			
			2	1	[l/min]	[l/min]			
Slotted head screw									
	G1/8	QS-4	130	100 ... 140 100 ... 140 <sup>1)</sup>	210	220 ... 250 230 ... 260 <sup>1)</sup>	28.2	525667	GRXA-HG-1/8-QS-4
		QS-6	140	120 ... 160 115 ... 165 <sup>1)</sup>	280	260 ... 300 270 ... 300 <sup>1)</sup>	28.2	525668	GRXA-HG-1/8-QS-6
	G1/4	QS-6	280	180 ... 260 200 ... 270 <sup>1)</sup>	430	410 ... 470 430 ... 490 <sup>1)</sup>	58.8	525669	GRXA-HG-1/4-QS-6
		QS-8	280	190 ... 260 200 ... 280 <sup>1)</sup>	470	440 ... 500 460 ... 520 <sup>1)</sup>	58.8	525670	GRXA-HG-1/4-QS-8

1) Unactuated